

Wheel Bearing Applications for Passenger Cars



/ Wheel Bearing Applications for Passenger Cars

**Automotive Catalog 2011**



/ A&S Fersa®



Fersa is an international company based in Zaragoza, Spain, known for its innovative approach to business. Our long experience, together with our access to the latest R&D technologies and modern manufacturing and supply-chain processes, has quickly placed us among the leading European bearing manufacturers.

Key to our success in becoming a global company present in more than 60 countries is the firm determination of our staff to try and exceed our customer's expectations through constant innovation.

The trust our customers have placed in us furthers our presence in all five continents and has been essential to establishing the Fersa brand as a reference of excellence, whose success is the result of a joint company-customer collaboration process.

Today, the market diversification strategy implemented right from the start means that more than 95% of our sales come from exports originating in Spain. Fersa has not only expanded production capacity in its Zaragoza plant by 300%, but has also built a new plant in Jianxing, China, in order to supply the manufacturing facilities of our global T1 customers in China.

Our passion for quality and for our customers, not only engages us in the continuous pursuit of excellence but it has become our style of management.

We hope that the information included in this new catalog, a product of this joint collaboration, will be of interest to you, as well as useful in your own pursuit of excellence.



/ Bearings  
Automotive Catalog 2011



## Index

---

01/	General fundamentals	14
02/	Wheel bearing designs for passenger cars	18
03/	Dimensioning of wheel bearing units	32
04/	Antilock-brake system (ABS)	42
05/	Lubrication	46
06/	Sealing	54
07/	Application list - Wheel bearing kits by brands	60
08/	Product range	216
09/	Content of the kits (bill of material)	236
10/	Cross references lists	246

---

# / Fersa history

**Currently, 90% of our turnover comes from exports to more than 60 countries on various continents.**

---

The history of Fersa Bearings goes back to 1968, when two family-owned businesses joined forces to create A&SFersa. As the company acquired international recognition, the name was changed to Fersa Bearing S.A., as it is known today.

Key to the success enjoyed since its beginnings has been the professional experience and technical know-how of the entire staff (from R&D through sales), as well as the shareholders determination to continuously invest in people and capital, in order to modernize all areas of the company.

Every product offered in our broad product line, be it for industrial, heavy vehicles or passenger car applications, is developed with the latest design and quality validation processes. The strict quality control of these processes is guaranteed by the use and application of the latest technologies in engineering design and manufacturing technology.

---







## / The product

Fersa offers one of the largest tapered roller bearings product lines available in the market, including metric, inches and special series, and double-row tapered roller bearings (with over 900 references).

In addition, our product line includes single-row ball bearings in different versions, open, ZZ and 2RS and dimensions, and double-row ball angular contact bearings, designed for the automotive market. We also have cylindrical bearings standard and special series, and axial and clutch bearings.

A catalog that features over 1600 market references, and a team of professionals with more than 40 years experience, is ready to answer and respond all customers' inquiries.

The development of a new business area focused on the needs of the light vehicle market, has added a new complete kit wheel product line with over 350 references.

And also, our new line of compact wheel bearings for heavy vehicles applications, in three distinct categories: HWT (Hub Wheel Truck), KWT (Kit Wheel Truck) and CWT (Compact Wheel Truck), with more than 20 new references.

Our flexibility and dynamism makes it possible for us to add more than 100 hundred new references each year, many of which are designed to the specifications of our customers.



# / Innovation

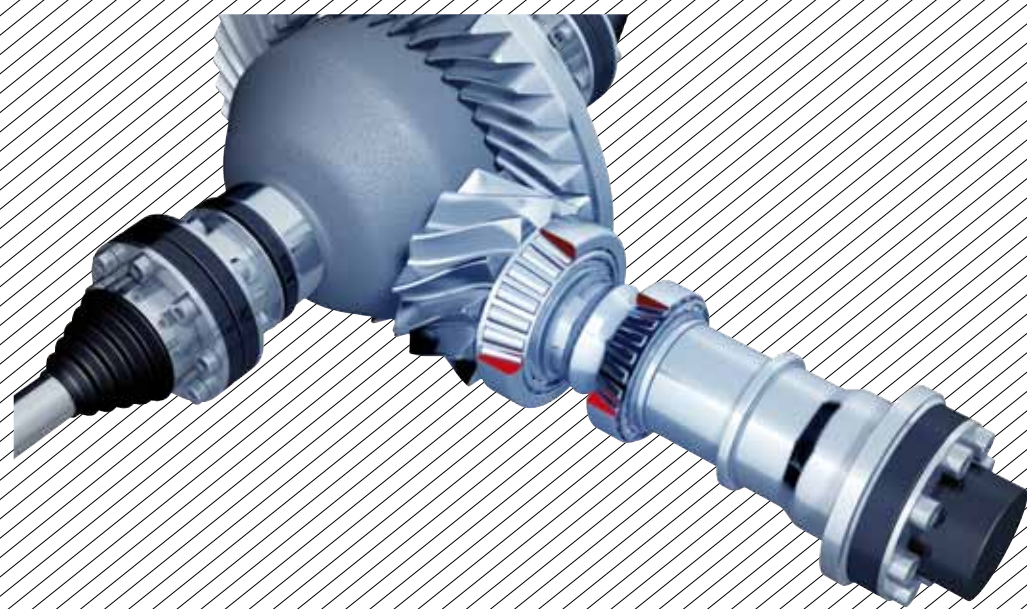

---

The decision to make innovation the number one priority, was —and is—key to the sustainable growth of the company. Project teams in our R&D department optimize the advantages of Simultaneous Engineering with the customer and help us reduce time-to-market of new products. Pro-active Quality Project Teams ensure that each one of these activities is correctly performed.

Collaboration with top-level Spanish technological institutes helped us create the NBE (Network for Bearing Excellence) in 2007. A knowledge based network to access the most advanced tools for analytical calculations and virtual simulation, as well as a significant capability for experimental testing, with more than 20 test-benches designed to evaluate and validate the applications of our products.

The market introduction in 2009 of the “Fersa HiPro” bearings family, or the new product line for truck wheels applications, are just two examples of Fersa’s innovation capabilities.

Investing every year, the equivalent of 6% of sales revenue in Research and Development, ensures the sustainability of this corporate priority which in turn helps us exceed customer expectations our ultimate goal.

---







## / Manufacturing processes

The ambitious investments made in our manufacturing plants has increased our production capabilities, automatized manufacturing processes and upped the quality standards of our bearings, while maintaining our flexibility towards satisfying our customers' needs.

The high quality of our manufacturing process has been homologated by global T1 suppliers to the OEMs around the world, including passenger car and commercial vehicle axle manufacturers. For this reason, Fersa has not only expanded production capacity in its Zaragoza plant by 300%, but has also built a new plant in Jianxing, China, in order to supply the manufacturing facilities of our global T1 customers in China.

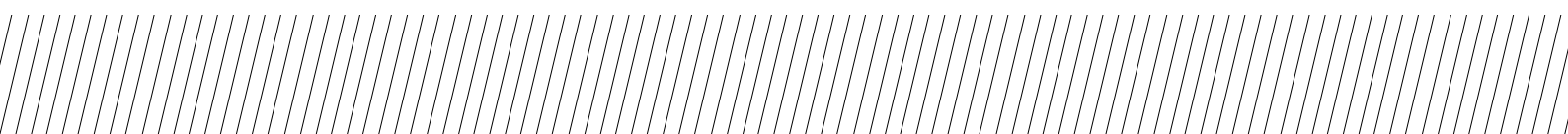

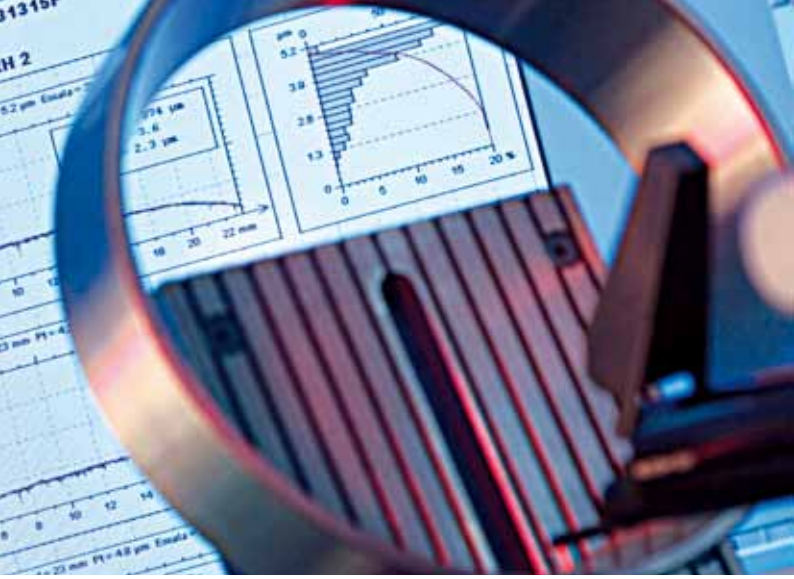

## / Quality

Throughout all our processes Fersa's staff is aware of the commitment to excellence made to our customers.

As manufacturer of high quality products, Fersa guarantees compliance with the highest standards of quality concerning the use of high quality steel in the production process, in the design of contact surfaces, and in correct packaging and lubrication of parts.

Our staff spares no effort to take care of the smallest details in order to ensure the best customer service, not only by supplying the best quality parts, but also by anticipating the possible needs of our customers in regards to service and deliveries.

In addition Fersa guarantees the performance of all our bearings, according to the current ISO 76 and ISO 281 Standards and in compliance with the recommended and correct use thereof.





# / Technical warranty

Fersa guarantees the quality of the product and the absence of defects, including shipping. Should a problem arise, Fersa guarantees the replacement of the part in question, after the corresponding tests performed by our Quality Control Department confirm the existence of such a defect.

Obviously, Fersa provides several contact channels in the event of any problem or doubt in relation to our products.

---

## **Customer care**

+34 976 333 850

[producto@Fersa.com](mailto:producto@Fersa.com)

---





  
A&S **Fersa**<sup>®</sup>  
Bearings





# 01/ General fundamentals

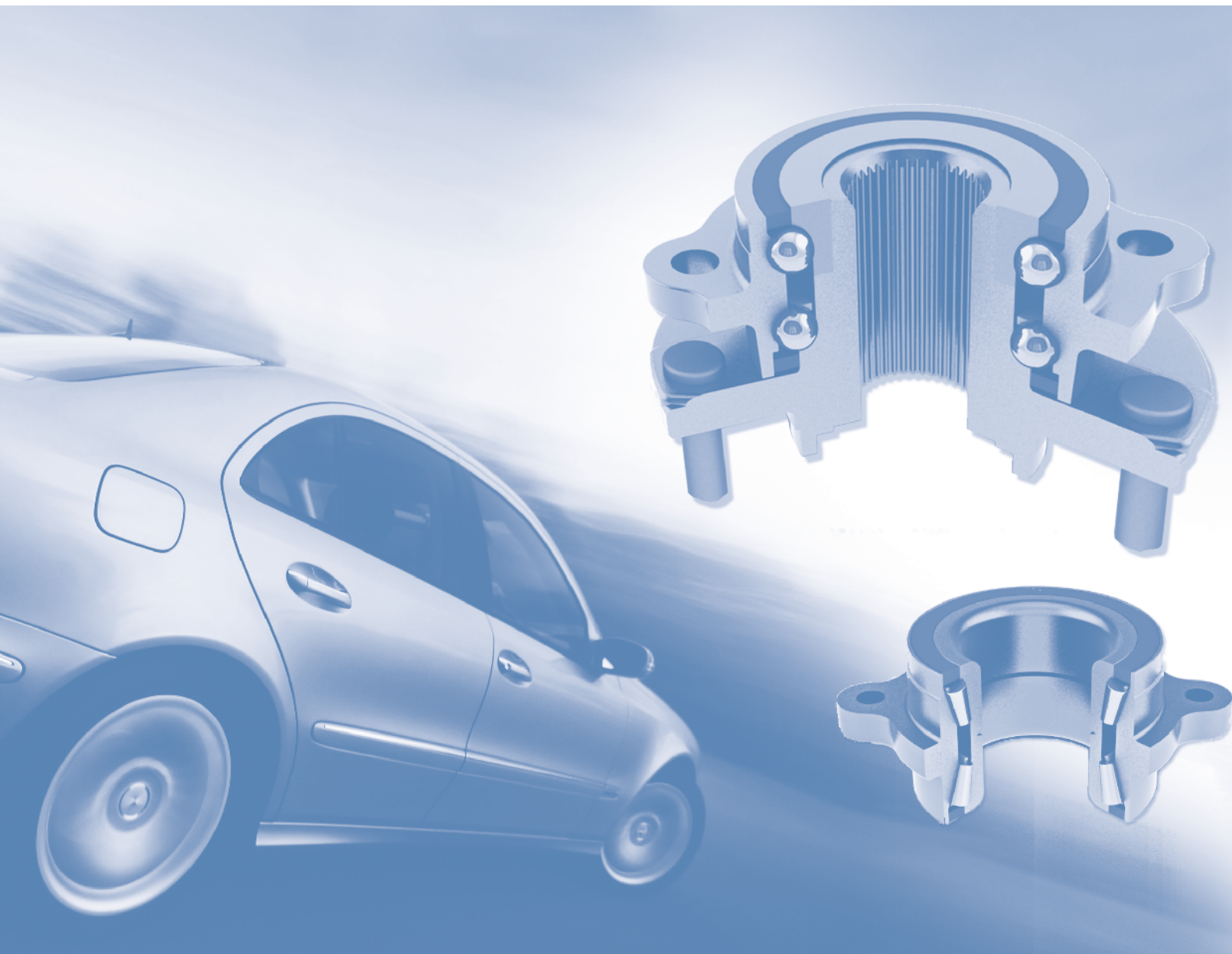



## 01 General fundamentals

---

1.1 - Definition	16
1.2 - Forces applied on the wheel	17

---

## General fundamentals

### 1.1 - Definition

Bearings are vital machine components designed to allow rotation between two elements of a mechanism. They must be able to sustain the load coming from their own weight, and gear actions, belts, chains, etc., with minimum friction.

A bearing is generally composed of:

- Two rings, one linked to the fixed element, the other fitted to the mobile element, enabling rolling motion.
- Assembly of rolling elements, balls or rollers, that allow the displacement between the two rings.
- A cage maintaining separately the rolling elements.

A bearing can be classified in two main families:

- Those with punctual contact between rolling elements and rings, called ball bearings.
- Those with linear contact, called roller bearings.

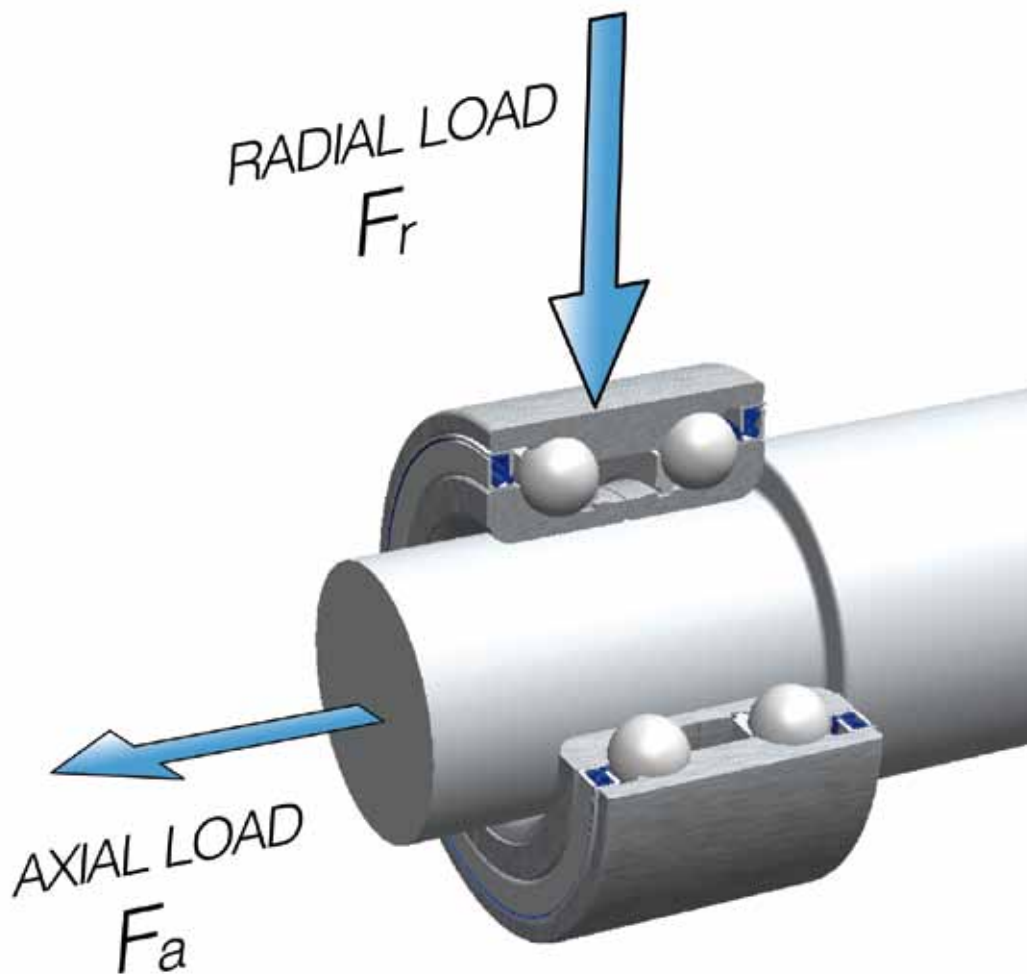

## 1.2 - Forces applied on the wheel

The assembly suspension and wheel of a vehicle should support several loads during vehicle acceleration, braking and cornering.

### Loads:

- Gravitational → opposite direction of the axle load (perpendicular to the road)
- Acceleration → between the tire and the road (in driving direction)
- Braking → between the tire and the road (opposite to driving direction)
- Cornering → between the tire and the road (in axial direction)

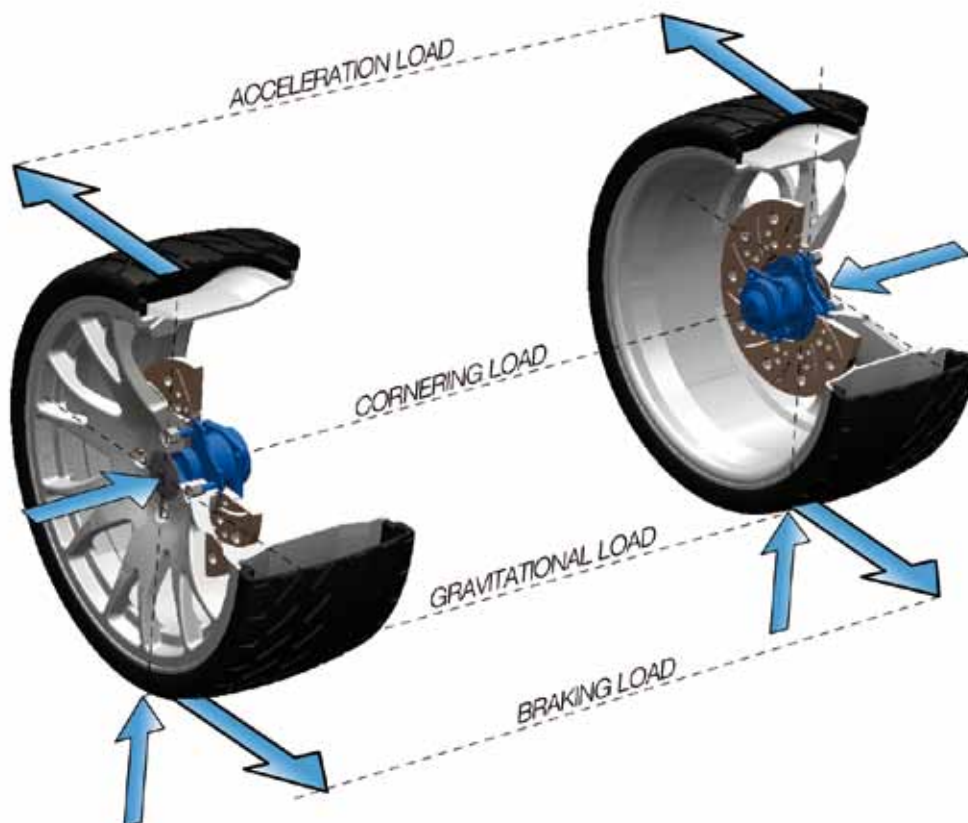



## 02/ Wheel bearing designs for passenger cars

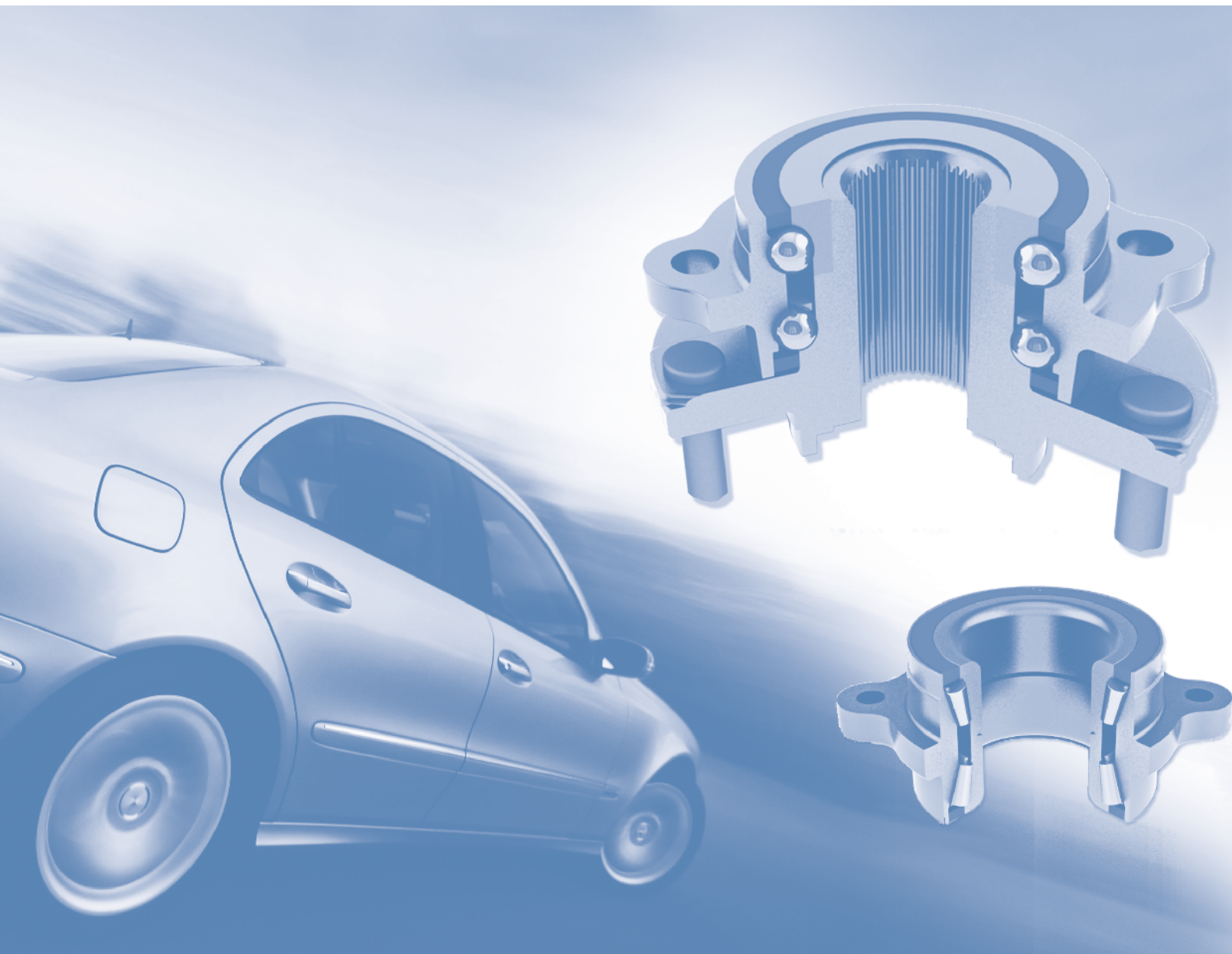





## 02 Wheel bearing designs for passenger cars

---

<b>2.1 - F-Zero</b>	<b>20</b>
<b>2.2 - F-One</b>	<b>23</b>
<b>2.3 - F-Two</b>	<b>26</b>
<b>2.4 - F-Three</b>	<b>29</b>

---

## Wheel bearing designs for passenger cars

### 2.1 - F-Zero

WHEEL BEARING KITS



For design F-Zero, Fersa has as bearing designations series F-18000 for ball bearings (also standard deep groove ball bearings) and series F-15000 for tapered roller bearings (also standard tapered roller bearings). F-Zero bearings are single-row deep groove ball bearings (F18000) and single-row tapered roller bearings (F15000).

F-Zero bearings have a simple design and possess a huge range for several automotive applications.

F-Zero tapered roller bearings are normally mounted in pairs. F-Zero ball bearings can be mounted as a single part. The axial clearance is set during assembly by applying the correct torque in the nut.



## 2.1.1 - Product advantages

### F-Zero: Ball bearings



- Low costs
- For front and rear wheels
- Low noise
- Low friction torque
- Most used
- Simple Design

### F-Zero: Tapered roller bearings



- High load carrying capacity
- For front and rear wheels
- Low costs
- Axial and radial load
- Simple maintenance
- Huge range

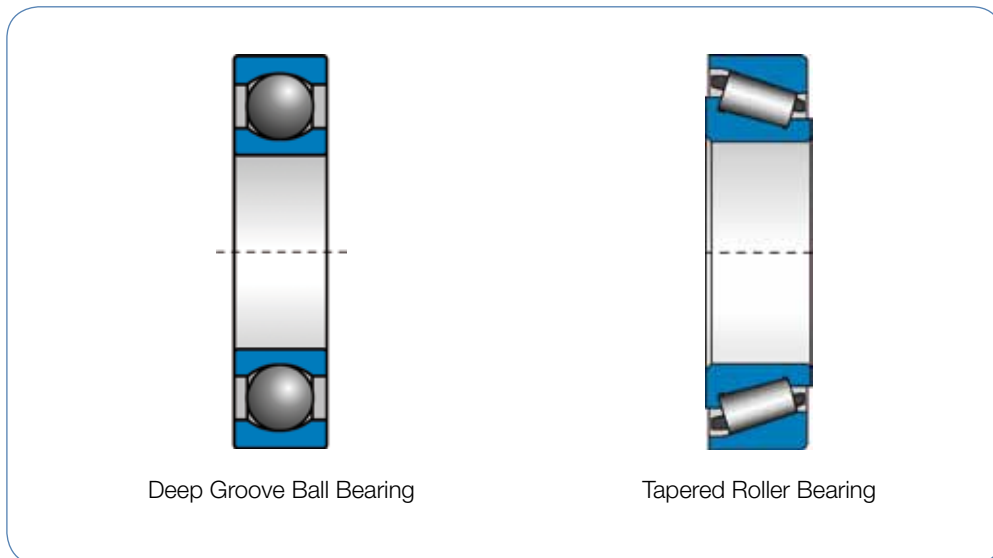

Deep Groove Ball Bearing

Tapered Roller Bearing

### 2.1.2 - Assembly

View of a F-Zero (combined single row tapered roller bearings). Axial clearance should be set accordingly during assembly by using the corresponding mounting torque.

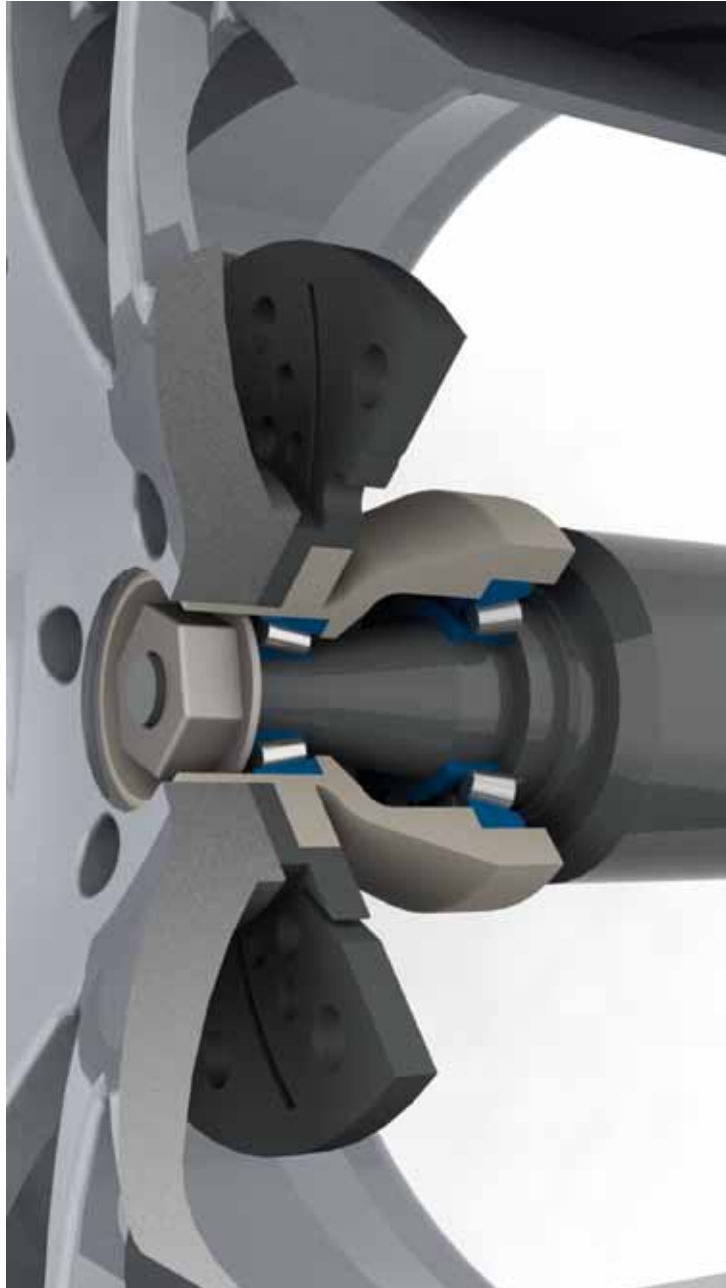

Assembly of F-Zero

## 2.2 - F-One

WHEEL BEARING KITS

# F One

For design F-One, Fersa has as bearing designations series F-16000 for ball bearings and series F-15000 for tapered roller bearings. F-One units are double-row angular contact ball bearings (F16000) and double-row tapered roller bearings (F15000) with two inner rings and one extended outer ring.

F-One bearing units have a defined and pre-set bearing clearance, lubrication for life and mounted sealing system. Double row angular contact ball bearings have a high moment for load capacity, meant to support the forces during cornering. F-One tapered roller bearing has a high load capacity through a space-saving construction.

The axial clearance is pre-set and takes into consideration the adjustment during assembly in order to reach the optimum preload after mounting. Additionally, the mounting seals eliminate the necessity for automotive manufacturers to use extra seals during operation.





## 2.2.1 - Product advantages

### F-One: ball bearings

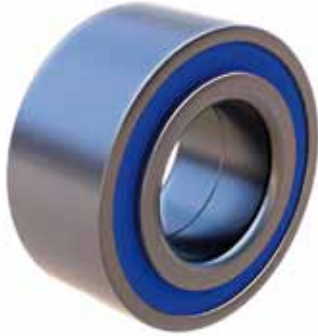

- Lubricated for life
- Low costs
- For front and rear wheels
- Arranged sealing system
- Defined and preset clearance

### F-One: Tapered roller bearings

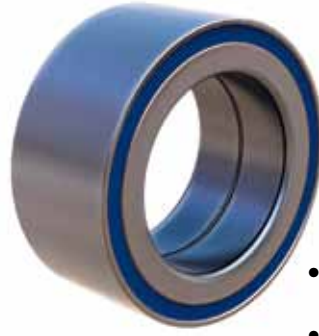

- Lubricated for life
- High load carrying capacity
- Defined and preset clearance
- Space-saving construction
- Arranged sealing system

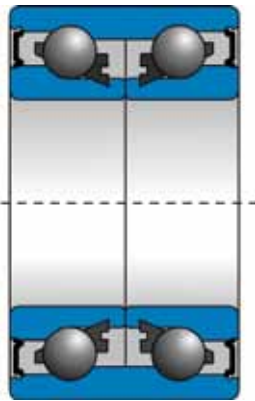

Double Row Angular Contact Ball Bearing

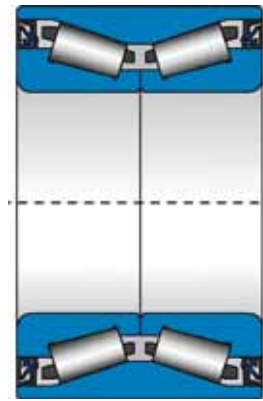

Double Row Tapered Roller Bearing

### 2.2.2 - Assembly

View of a F-One after assembly. Wheel hub and drive shaft are connected to the inner rings of the bearing. Outer ring is mounted into the knuckle.

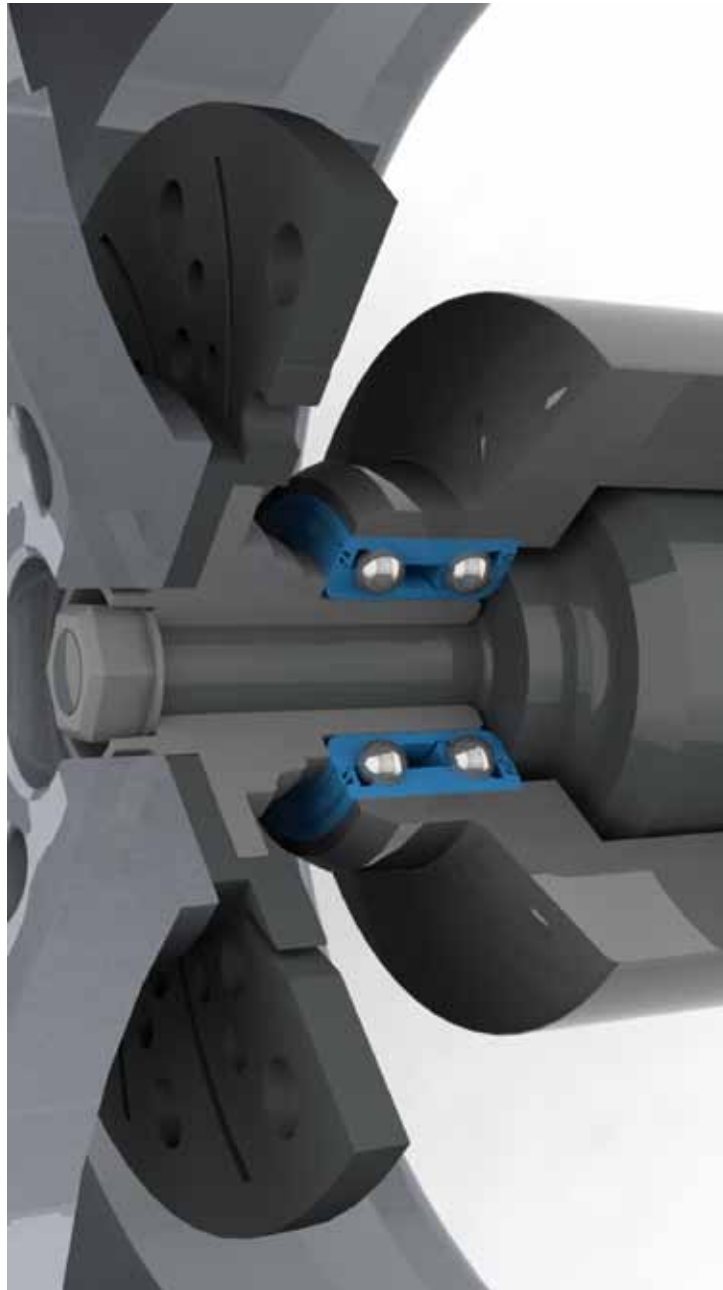

Assembly of F-One

### 2.3 - F-Two

WHEEL BEARING KITS



For F-Two, Fersa has as bearing designations series F-16000 for ball bearings and series F-15000 for tapered roller bearings. F-two units are flanged double-row angular contact ball bearings (F16000) and flanged double-row tapered roller bearings (F15000) with two inner rings and one flange as the outer ring.

**Rotating Outer ring for non-driven axles:** Wheel and brake disc are assembled at the flange. The bearing unit is mounted on the axle and fixed with a nut.

**Rotating Inner ring for non-driven axles:** The flange is fixed to the vehicle. The bearing unit is mounted on the axle and fixed with a nut.

**Rotating Inner ring for driven axles:** The flanges are fixed to the axle housing. Wheel hubs and drive shafts are connected to the inner rings.

F-Two is a combination of F-One bearing's cost efficiency and the advantages of the wheel flanges integration for bearing assembly at the brake disc and wheel. F-Two is a compact unit with defined and preset bearing clearance, lubrication for life and mounted sealing.

The axial clearance is pre-set and takes into consideration the adjustment during assembly in order to reach the optimum preload after mounting. Additionally, the mounting seals eliminate the necessity for automotive manufacturers to use extra seals during operation.



### 2.3.1 - Product advantages

#### F-Two: ball and tapered roller bearings

- Lubricated for life
- For front and rear wheels
- Arranged sealing
- Defined and preset clearance
- Integrated wheel flanges
- Possibility to integrate ABS sensor
- Easy assembly
- Lower human interference during assembly
- Lower number of components for the customer

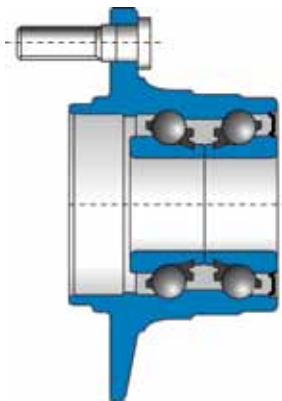

Rotating Outer Ring - non-driven wheels

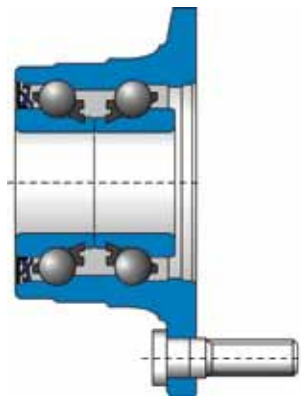

Rotating Inner Ring - non-driven wheels

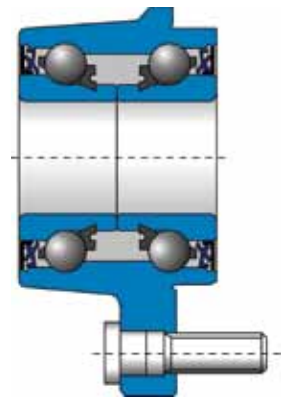

Rotating Inner Ring - driven wheels

### 2.3.2 - Assembly

View of a F-Two (rotating inner rings for driven axles) after assembly. The flanged outer ring is fixed to the knuckle. Wheel hubs and drive shaft are connected to the inner rings.

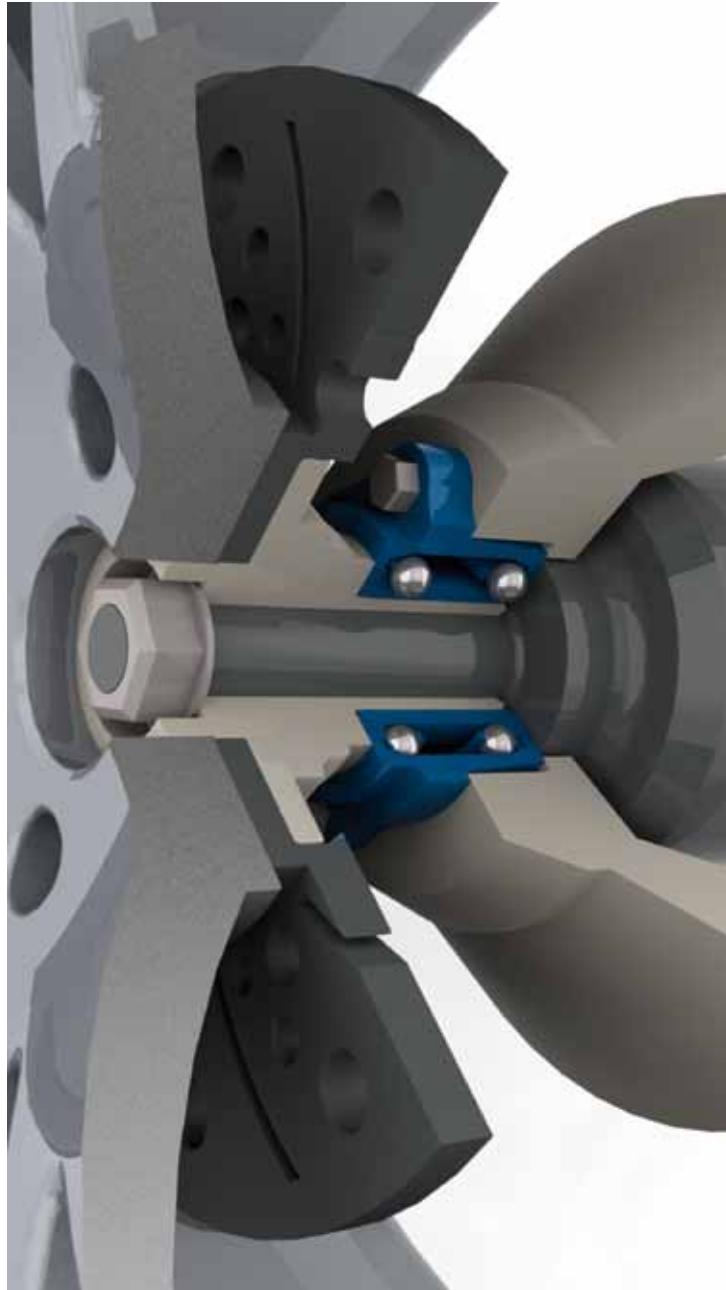

Assembly of F-Two

## 2.4 - F-Three

WHEEL BEARING KITS

# F Three

For F-Three, Fersa has as bearing designations series F16000 for ball bearings and series F15000 for tapered roller bearings. F-Three units are equipped with two flanges (outer and inner rings).

**Rotating Outer ring for non-driven axles:** The wheel and brake disc are assembled at the outer ring flange. Inner ring flange is fixed on the vehicle. Pre-load is already set.

**Rotating Inner ring for non-driven axles:** The wheel and brake disc are assembled at the inner ring flange. The outer ring flange is assembled on the vehicle. Pre-load is already set.

**Rotating Inner ring for driven axles:** The wheel and brake disc are assembled at the inner ring flange. The outer ring flange is assembled on the vehicle. Pre-load is already set. The shaft end is mounted in the bearing splines and transmits rotation from the engine to the wheel.

F-Three is a bearing unit with a high integration level, with a flange fixed at the disc brake and wheel carrier, at the highest accuracy. The encoders generate the required ABS signal. This design reduces expenses in the assembly due to the construction of the two flanges.





## 2.4.1 - Product advantages

### F-Three: ball and tapered roller bearings

- Lubricated for life
- For front and rear wheels
- Arranged sealing
- Possibility of ABS integration
- Easy mounting
- Lower human interference during assembly
- Lower number of components for the customer
- High precision of disc brake and wheel guidance
- Reduced expenses of assembly due to construction of two flanges
- Pre-load is defined through the process
- Lubricated for life
- High load carrying capacity
- Defined and preset clearance
- Space-saving construction
- Arranged sealing system

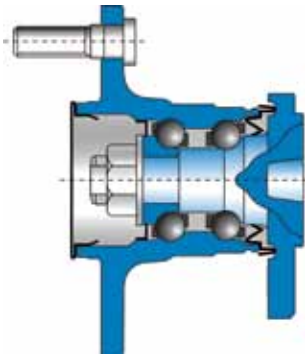

Rotating Outer Ring - non-driven wheels

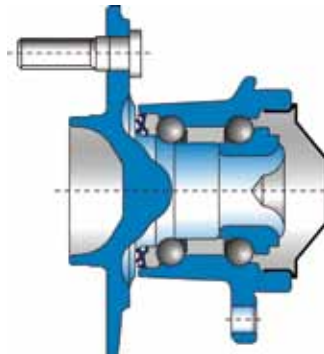

Rotating Inner Ring - non-driven wheels

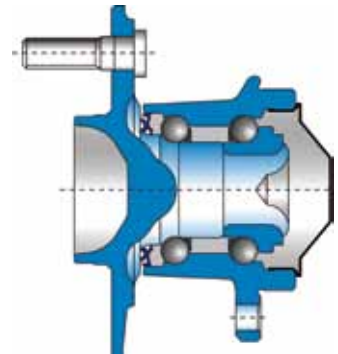

Rotating Inner Ring - driven wheels

### 2.4.2 - Assembly

View of a F-Three (rotating inner rings for driven axles) after assembly. Wheel and brake disc are fixed at the flanged inner ring of the bearing. The flanged outer ring is fixed at the vehicle body.



Assembly of F-Three

## 03/ Dimensioning of wheel bearing units

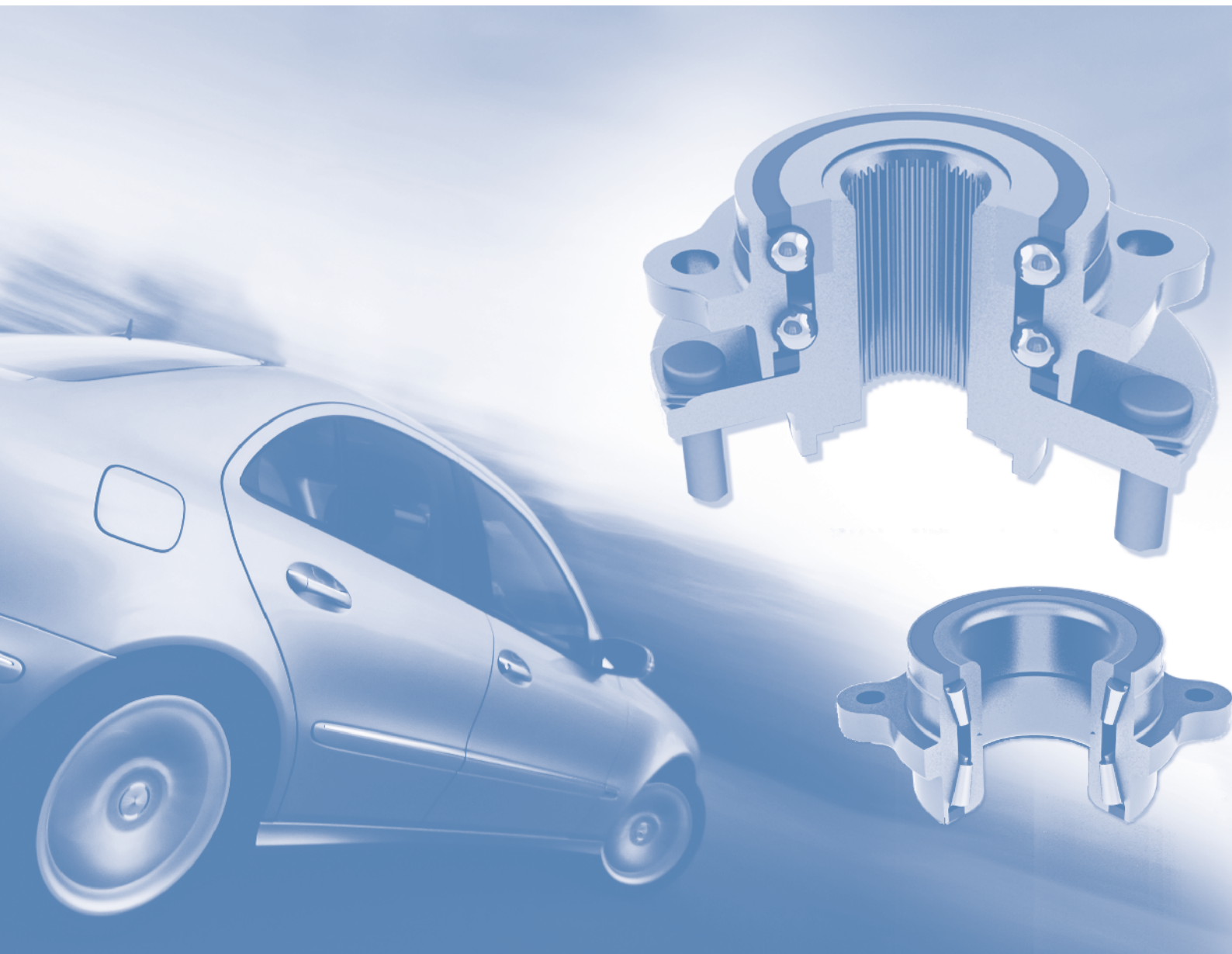



## 03 Dimensioning of wheel bearing units

---

3.1 - Basics	34
3.2 - Lifetime calculation	34
3.3 - Contact angle $\alpha$	35
3.4 - Curvature ratio	36
3.5 - Fit influence	36
3.6 - Clearance	38
3.7 - Pre-load	39
3.8 - Relation between pre-load and axial clearance before and after mounting	39
3.9 - Influence of pre-load / axial clearance on the bearing lifetime	40

---

## Dimensioning of wheel bearing units

### 3.1 - Basic

Driving loads must be carried by the rolling elements (contact surface between raceway and rolling element). Due to this fact, the dimensions of the rows as well as of rolling elements are relevant for the bearing lifetime.

The driving conditions, i.e. number of cycles, rotation speeds, curvature ratio, impact factor, time ratio [%] are crucial for lifetime calculation. Application data as axle load, bearing offset, dynamic radius, adjustment, etc must also be taken into consideration for lifetime calculation.

### 3.2 - Lifetime calculation - $f_L$

The  $f_L$ - value is used to help selecting the correct bearing size. It comes from the ISO standard formula for lifetime and is used to compare new bearing designs to well-proven and already defined types.

The  $f_L$ - value is a non dimensional value and is meant to embrace different influences as wheel loads, numbers of revolutions, temperatures, environmental conditions, lubrication, cleanliness in the bearing, etc.

$L_{10}$ : nominal rating life [ $10^6$  revolutions]

$L_{n10}$ : nominal rating life [h]

C: dynamic load rating [kN]

P: equivalent dynamic load [kN]

p: life exponent:  $p = 3$  for ball bearings;  
 $p = \frac{10}{3}$  for roller bearings

n: number of revolutions [ $\text{min}^{-1}$ ]

$f_L$ : index of dynamic stressing [-]

$$L_{10} = \left( \frac{C}{P} \right)^p \quad [10^6 \text{ revs}]$$

$$L_{n10} = \frac{L_{10} \cdot 10^6}{n \cdot 60} \quad [\text{h}]$$

$$f_L = \sqrt[p]{\frac{L_{n10}}{500}} \quad [-]$$



### 3.3 - Contact angle

The rolling elements of a ball bearing touch the raceways at one point. The connecting line of these points runs along the raceways and goes through the center of the rolling element. Along this line an externally applied load will be transmitted from one bearing ring to the other. This line is therefore named the contact line of the bearing. The contact angle  $\alpha$  is made by this line and the radial plane.

- Nominal contact angle  $\alpha_0$ : is measured during the unloaded bearing condition, in which the balls are not in stress contact with the raceways.
- Operating contact angle  $\alpha$ : the contact angle in the bearing, which takes into consideration external influences as loads and adjustment.

The contact angle projected on the bearing axis forms an effective bearing spread. The bigger the effective bearing spread, the torque generated by the loads which can be withheld by cornering is increased.

For direct driving conditions a low contact angle leads to the longest lifetime. However this is very unfavorable for cornering.

An increased contact angle leads to the longest lifetime and a strong cornering load, but it decreases the theoretical fatigue running time for travelling straight ahead. The optimal contact angle depends on the driving conditions.

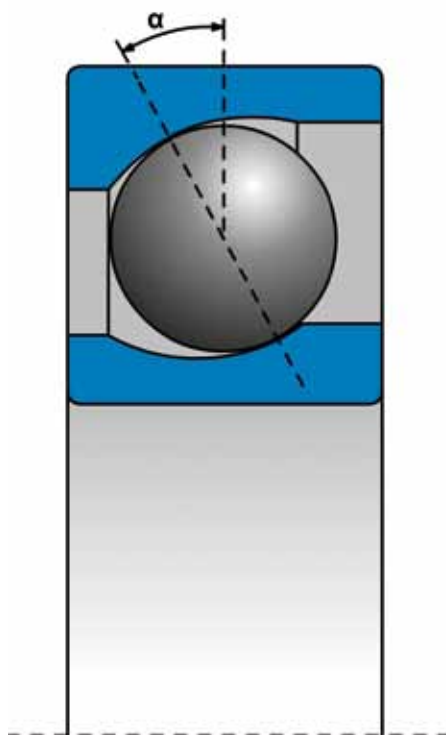

### 3.4 - Curvature ratio

For bearings with curved raceway and rolling elements, the radius of the raceway profile is slightly larger than the radius of the rolling element. This curvature difference is defined by the parameter  $k$ :

$$\text{curvature ratio } \kappa = \frac{\text{groove radius} - \text{rolling element radius}}{\text{rolling element radius}}$$

$r_J$  = groove radius of the inner ring raceway

$r_A$  = groove radius of the outer ring raceway

$r_0$  = distance of the centers of curvature

$D_W$  = ball diameter

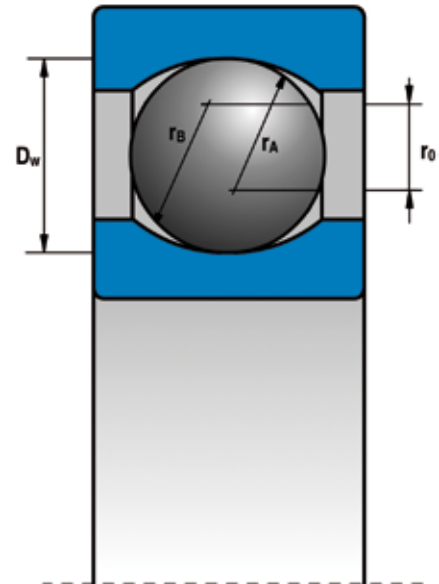

If the curvature ratio is restricted i.e. the raceway radius approaches the ball radius, a slipping effect on the contact surface will appear, because the ball only runs off in two points of the contact area on the outer and inner rings and drifts forwards/backwards on the rest of raceway area. However the contact pressure is distributed on a large part of the raceway during a light oscillation.

On the other hand, if the curvature ratio is too big, the balls run off without the slipping effect. However, the maximum contact pressure will be higher, since the contact area of the contact ellipse becomes smaller.

### 3.5 - Fitting

#### Fitting tolerances

##### Housings:

The tolerance zone is defined as a spherical zone limited by the upper and lower limit dimensions of the part. The tolerance zone is therefore determined by the amount of tolerance and its position related to the basic size. The position of the tolerance zone, related to the basic size (zero line), is determined in the ISO system by a so-called basic deviation. The ISO system defines 28 classes of basic deviations for the holes. These classes are marked by capital letters (A, B, C ... ZC). The tolerance zone for the specified dimensions in the drawing is indicated by a tolerance mark, which consists of a letter marking of the basic deviation and a numerical marking of the tolerance grade (e.g. H7, H8, D5, etc.).

## Shafts:

The tolerance zone is defined as a spherical zone limited by the upper and lower limit dimensions of the parts. The tolerance zone is therefore determined by the amount of tolerance and its position related to the basic size. The position of the tolerance zone, related to the basic size (zero line), is determined in the ISO system by a so-called basic deviation. The ISO system defines 28 classes of basic deviations for the shafts. These classes are marked by lower case letters (a, b, c... zc). The tolerance zone for the specified dimensions in the drawing is indicated by a tolerance mark, which consists of a letter marking of the basic deviation and a numerical marking of the tolerance grade (e.g. h7, h6, g5, etc.).

Bearings must be fixed on the axle and also in the housing in radial, axial and circumferential directions. Radial and circumferential adjustments are achieved by tightly fitting the rings of the bearing. Axial location can partially be achieved by ensuring a tight fit.

It is necessary to take into consideration the following requirements when selecting the correct fitting:

- Bearings must be mounted accordingly and supported over their circumference in order to optimize the load-carrying capacity.
- Sliding between surfaces in a circumferential direction is not allowed in order to prevent damaging.
- Bearing must have axial latitude to adjust length variations of shaft and housing.
- Correct assembly and disassembly.

The tolerance is the difference which can be tolerated or admitted between the nominal value and the real or effective value in the physical and chemical characteristics of a material, piece or product.

The measuring unit for tolerances is the **micron ( $\mu\text{m}$ )**.

## Fitting - shaft size variation

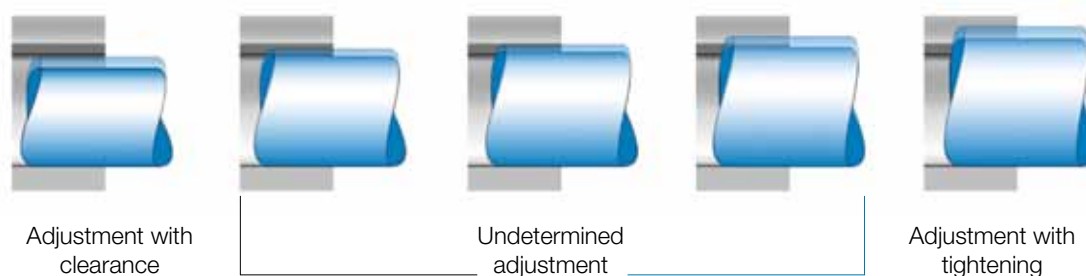

## Fitting - housing size variation

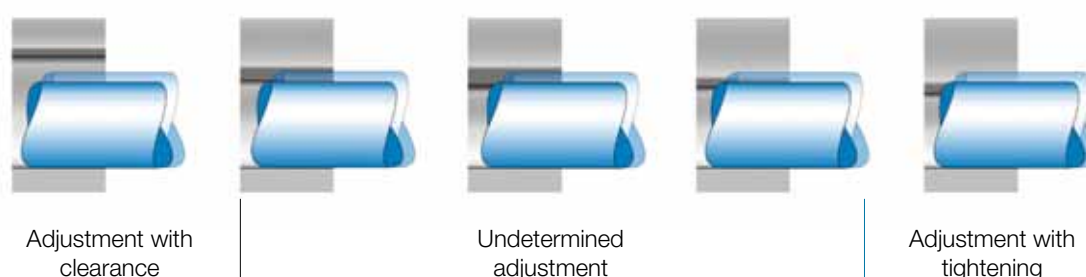

### 3.6 - Clearance

The total distance through which one bearing ring can be moved relative to the other in the radial direction (radial internal clearance) or in the axial direction (axial internal clearance) without a load.

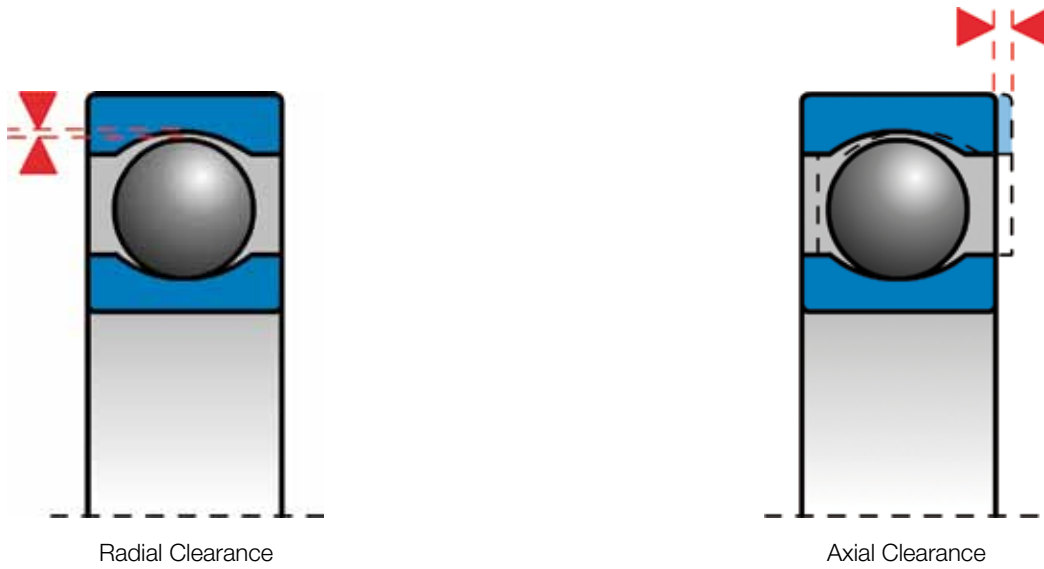



### 3.7 - Pre-load

The preload serves to provide a minimum load on the bearing and prevent bearing damage as a result of sliding movements of the rolling elements.

The main reasons to apply bearing preload are to:

- Enhance stiffness
- Reduce running noise
- Enhance the accuracy of shaft guidance
- Compensate for wear and settling (bedding down) processes in operation
- Provide long service life

### 3.8 - Relation between pre-load and axial clearance before and after mounting

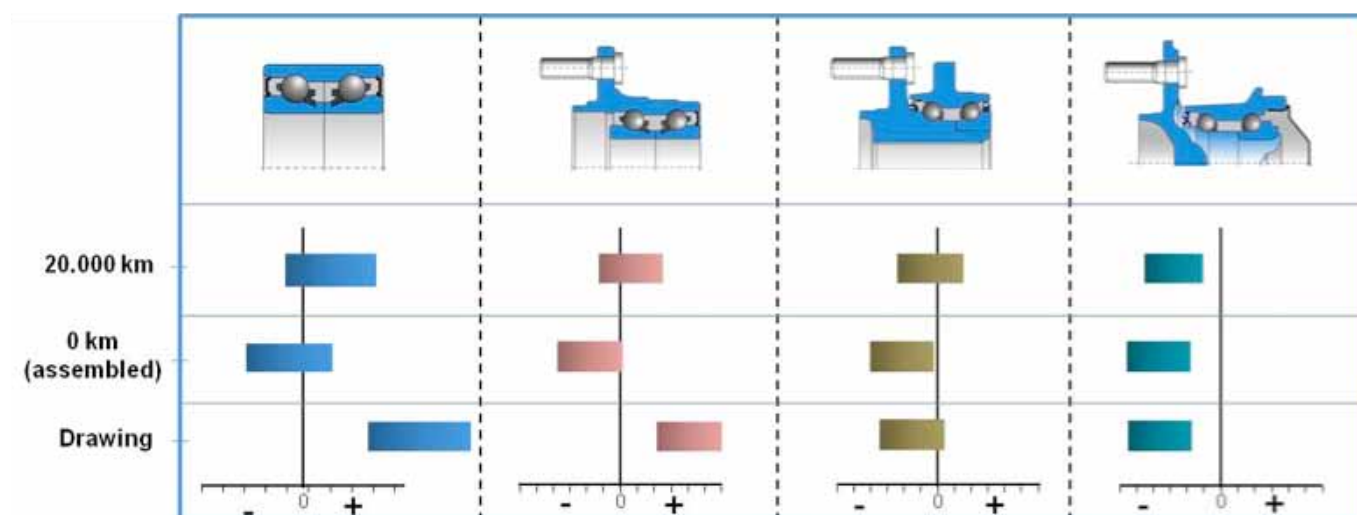

Interference generated by adjustment in F-One designs (double row tapered roller bearings and double row ball bearings) has a significant influence in Axial Clearance / Pre-Load relations.

In this kind of bearings there are 2 contact surfaces: one between the housing and outer ring and another between the shaft and inner rings. This interference generates a bearing elastic deformation, which narrows the axial clearance defined in the drawing.

In addition to the adjustment, the mounting torque (applied on the nut) will usually convert the initial axial clearance into a pre-load after assembly.

For F-Two designs there is only one contact surface (between shaft and inner rings), which makes the axial clearance specified in the drawing smaller than the clearance of F-One designs. The mounting torque is also required for this kind of bearings in order to define the final pre-load.

F-Three is the Fersa design with the highest integration level and the pre-load is already defined from the production process. Due to this fact, there is a very low variation of the pre-load (insensitivity). This design avoids mistakes by setting the pre-load during the assembly.

### 3.9 - Influence of pre-load / axial clearance on the bearing lifetime

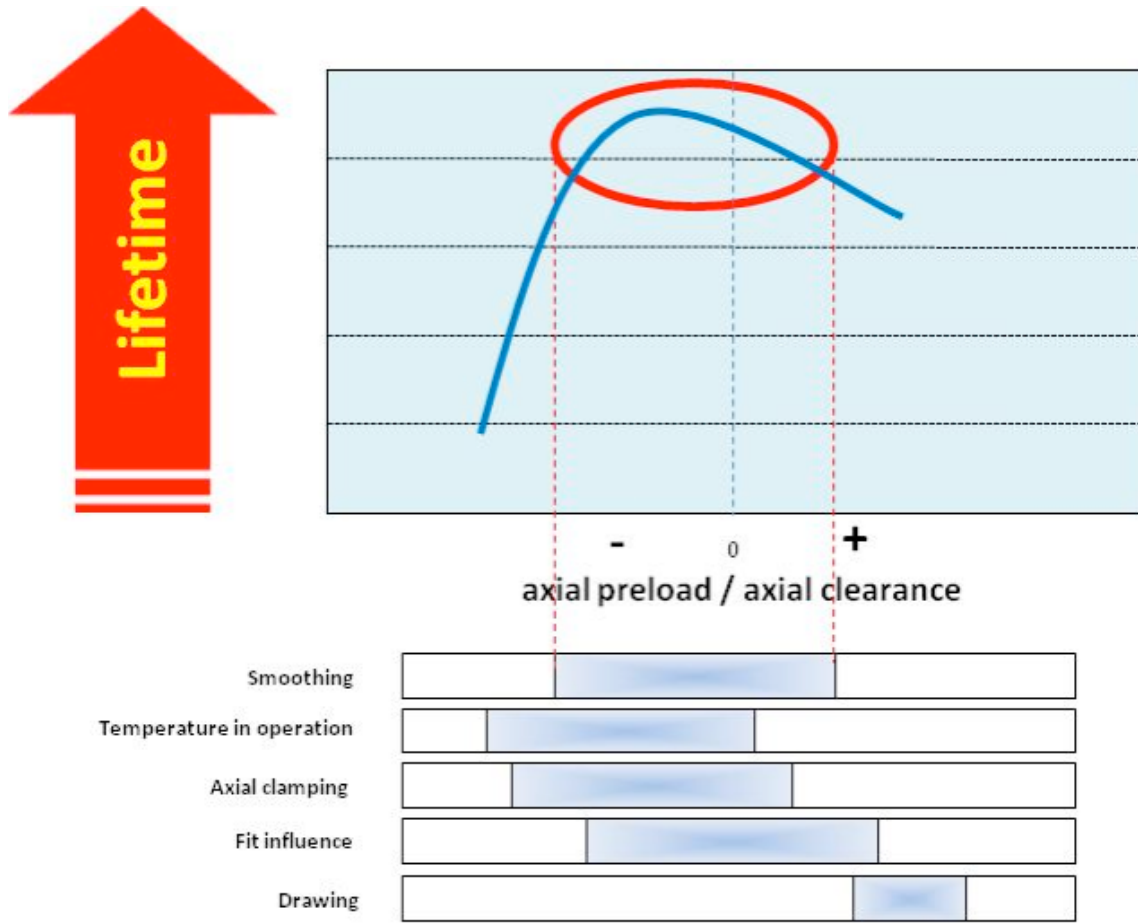

Wheel bearings usually achieve their longest lifetime performance in operation under pre-load. Except for Fersa F-Three where the pre-load is already set, the pre-load of other wheel bearing designs have to be set during assembly.

A significant part of this setting is the fit influence. Tolerances of the bearing rings and also tolerances from the housing and shaft should be taken into consideration during mounting in order to reach the theoretical pre-load described in the drawing.

After the mounting it is mandatory to apply the corresponding mounting torque with a nut (specified by the vehicle manufacturer). With this procedure the bearing should operate in its best condition



# 04/ Antilock-brake system (ABS)

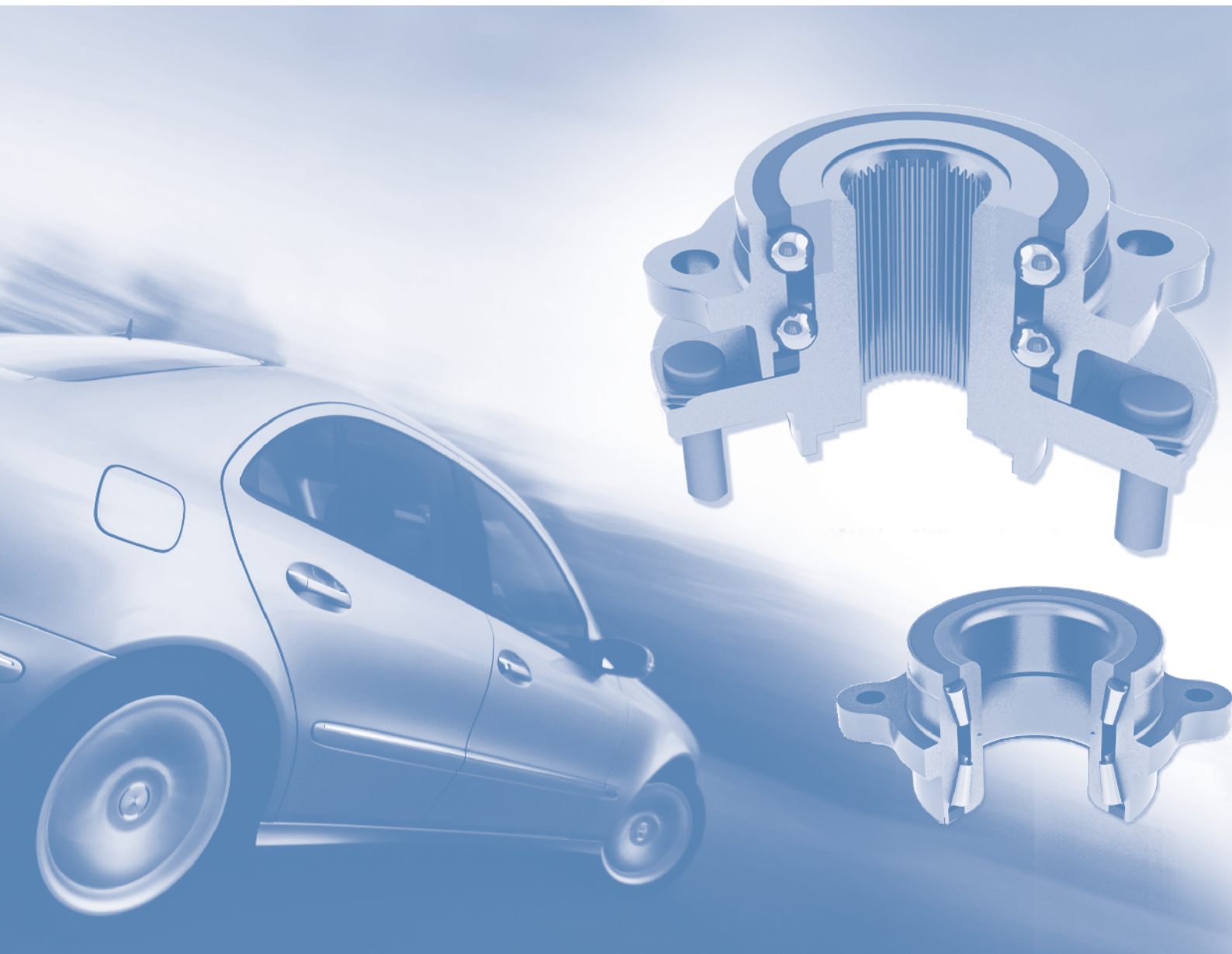





## 04 Antilock-brake system (ABS)

---

4.1 - Introduction	44
4.2 - Passive encoder	44
4.3 - Multi-pole encoder	45
4.4 - Sensors	45

---

# Antilock-brake system (ABS)

## 4.1 - Introduction

With the evolution of automotive technology, safety has become a fundamental requirement. For reasons of both safety and driving comfort, more and more vehicles are being equipped with speed sensing devices (primarily sensors that provide a signal system with the wheel speed information). The optimum wheel speed sensor solution is unique for each individual application. Due to this fact, the Antilock Brake System (ABS) has become globally used in the automotive sector, ensuring safe braking on slippery and icy roads.

ABS functions to prevent individual wheel lockup. It helps the driver, by providing steering control, in order to keep control of vehicle in case of emergency. Since a locked up wheel cannot be steered, the ABS permits the driver to control the vehicle even during strong pumping of the brake pedal and it reports active data used to control decisions as a reaction to changing of road conditions.

## 4.2 - Passive encoder

A passive encoder is generally a metallic impulse ring and it rotates at the same speed of the wheel. The sensor should be mounted nearby the impulse ring. Apart of getting a signal from the impulse ring, a sensor should transfer it to the Electronic Control Unit (ECU), in order to control the brake force. It is not mandatory that an impulse ring should be assembled on the bearing. It can be mounted on rotating components, which belong to the wheel system as CV-Joint, drive shaft, etc.



Passive axial encoder



Passive radial encoder



F-Two equipped with passive radial encoder

### 4.3 - Multi-pole encoder

This system uses a magnetic ring, in place of a conventional metallic impulse ring. The magnetic sensor (active sensor) mounted on the vehicle is able to detect rotation speed of the wheel. The multi-pole encoder can be designed in both radial and axial direction.

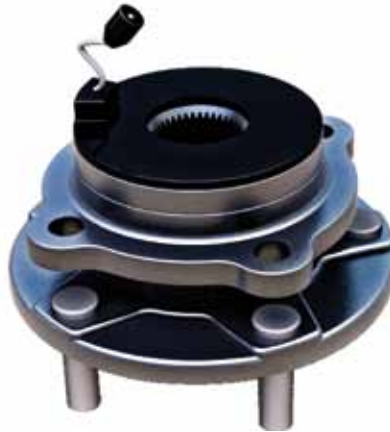

Active sensor + multi-pole encoder

### 4.4 - Sensors

By applying an active sensor, the multi-pole encoder permits a regular output. For this reason, the encoder can recognize wheel rotation speed, even when running at a very low speed. Active sensor do not require magnets, reducing cost and weight.

Depending on vehicle requirements and design, the sensors are defined as non-integrated and integrated designs. The non-integrated design is used in the most ordinary applications and the integrated design is used when weight and assembly time saving are needed.

There are two types of sensors: passive and active. The passive sensors can provide a signal at low speed, which would be enough for the operation of a vehicle equipped with ABS. The active sensors can provide signal at speed zero, which is needed for systems such as navigation and traction control.

Independently of the solution, sensor integration would offer:

- Reduction of assembly time
- Reliability improvement
- Reduction of space requirements
- Weight reduction



Passive sensor



Active sensor

# 05/ Lubrication

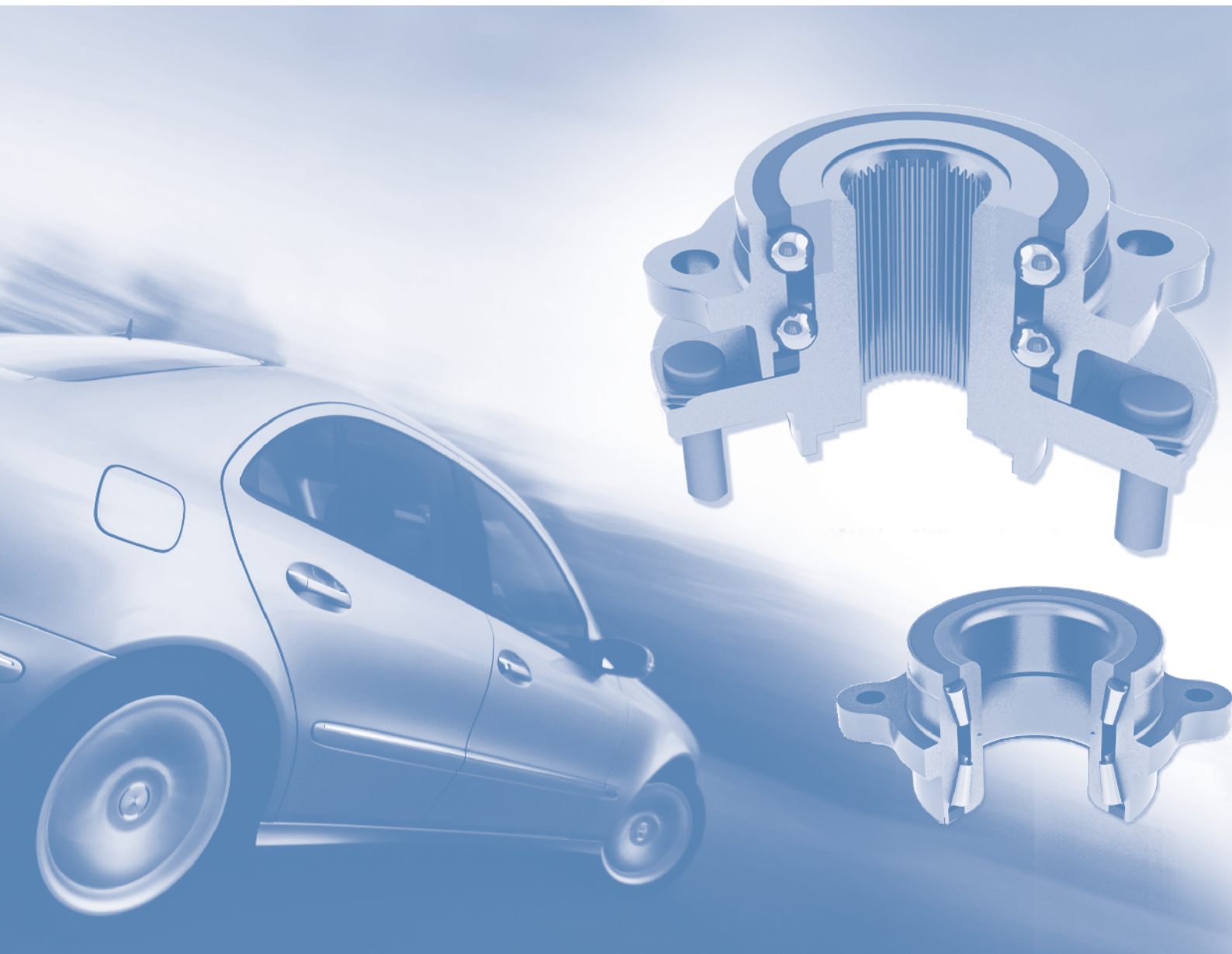



## 05 Lubrication

---

<b>5.1 - Introduction</b>	<b>48</b>
<b>5.2 - Types of lubrication</b>	<b>49</b>
<b>5.3 - Types of lubricants</b>	<b>50</b>

---



# Lubrication

## 5.1 - Introduction

Approximately 45% of bearing failure and breakdowns are due to inadequate or insufficient lubrication, hence why lubrication is such an important aspect of the bearing.

The main function of a lubricant is to allow for the correct rotation a movement between the various rolling elements of a bearing, reducing friction between the contact surfaces and therefore reducing damages.

Lubrication inhibits contamination, avoids impurities, improves sealing and protects against corrosion. The main purpose of the lubrication process is to prolong the service life and optimal performance of the bearing for as long as possible.

Today there is an increasing concern for the effect that lubricants may have on the environment. Recently Fersa has collaborated, together with other companies and technological centers, with the CRAFT project of “the BIOMON European Commission, towards long life bio-lubricants, using advanced design and monitoring tools”, whose main objective has been the development of bio-degradable lubricants which are to be used in different mechanical industrial applications.

## 5.2 - Types of lubrication

To lubricate is to apply a layer of lubricant between the raceways and the rolling elements. This keeps the different contact surfaces separate and prevents direct metal-to-metal contact between them.

The choice of lubricant depends on several factors:

- Viscosity of the lubricant.
- Geometric conditions of the rolling elements (the superficial texture is especially important).
- Environmental conditions (temperature, vibrations...), as well as the presence of foreign particles and contamination.
- Working conditions (rotation speeds, loads, mounting, fatigue...).

All of the above are determining factors when selecting the best lubricant and best application process (amount, cleaning, re-lubrication intervals...) for the specific bearing. Depending on the lubrication applied, different lubrication situations can occur:

### 5.2.1 - Total or hydrodynamic lubrication (pic. 1):

The surfaces of the elements implicated in the rotation are totally separated by the lubricant film in place. This is the ideal lubrication situation, since there is no wear between surfaces and the friction rate is very low.

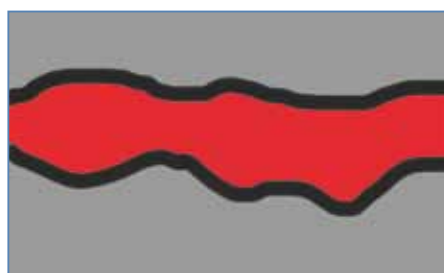

Total or hydrodynamic lubrication (pic. 1)

### 5.2.2 - Partial lubrication (pic. 2):

This is the true lubrication scenario, since there are some areas in contact despite the existing layer of lubricant.

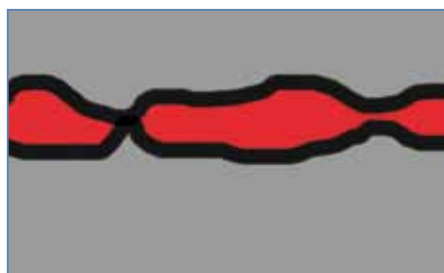

Partial lubrication (pic. 2)

### 5.2.3 - Lubrication by boundary layer (pic. 3):

When the amount of lubricant is insufficient or the relative movement too slow, the layer is thinner and cannot prevent metal-to-metal contact; which causes more friction and generates more heat, which in turn increases the temperature and further reduces the layer of lubricant protection available.

To prevent this, additives are used in the lubricant. These additives react with the metal parts and generate a boundary layer that reinforces the lubricant protection.

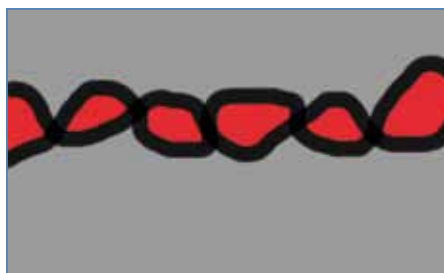

Lubrication by boundary layer (pic. 3)

### 5.2.4 - Solid lubrication:

For less severe working conditions, there are different types of solid lubricants (graphite, lithium grease...) to help improve lubrication that prevents direct metal-to-metal contact between surfaces.

### 5.3 - Types of lubricants

There are two main lubrication options to choose from, grease or oil:

#### 5.3.1 - Grease

Grease is the most widely used type of lubricant:

- Simpler design and more economical lubrication system.
- Less maintenance needed (there is a life lubrication option available).
- Good tightness and low contamination risk (cleaning).

Grease lubrication provides a high safety level at low speeds. They are oil based (mineral, silicon, ester) mixed with lithium, sodium or calcium soap thickener for density (sometimes salt from the metal soap is added to form a thickening complex). Polyurea, Teflon or bentonite can be used instead of soap.

When selecting grease, the consistency, temperature range and corrosion resistance, miscibility, mechanical stability, rate of fluidity, etc., determine its suitability to perform under different conditions and work requirements (load carrying ability, speed, temperature, vibrations, etc.). The following table shows detailed information of the capacities of the different greases:

Type of grease	Lithium		Sodium		Calcium		Bentonite	Polyurea	Teflon
	N	C	N	C	N	C			
Temperature (°C)	-30 / 130	-30 / 160	-30 / 100	-30 / 120	-30 / 60	-30 / 130	-30 / 160	-40 / 210	-35 / 250
Pressure	1	2	1	2	1	2	1	1	2
Water resistant	3	2	1	1	3	2	3	3	3
Corrosion	2	1	2	3	2	2	1	1	1

N= Normal  
 C= Complex  
 1- Regular resistance      2- Good resistance      3- Very good resistance

#### 5.3.2 - Lubrication processes-grease

Under not very severe working conditions, there is a life lubrication option that also uses seals to help keep the lubricant inside in the bearings (especially where high vibrations and temperatures are concerned). However, under more severe conditions re-lubrication is necessary. Also the bearing must be greased once it is mounted, before being operative (reduces contamination risk) and should have been cleaned before greasing if not new. The amount of grease should not be excessive (possible engine size-up), nor should it be insufficient (damage to bearing).

The amount of grease should range approximately between 20 to 35% of the empty space in the bearing. The bearing should be fully rotated so that it is totally immersed in grease.

$$g = 0,0121 \times (D-d) \times B$$

### 5.3.3 - Oils

Oil lubrication is used in 10% of bearing applications.

- Good performance at high speeds and heavy loads.
- Better ability for heat dissipation.
- More precise and efficient cleaning of particles.
- Possibility of recycling oil to lubricate other bearing elements (cost reduction).
- Easy monitoring of lubricant (condition and level).

The following oils are used on bearing applications:

- Minerals (most often used).
- Synthetics (used for specific applications): polyolefin, polyglycol, ester, oil fluorides, silicon oils...

When selecting an oil with the correct viscosity; temperature range, speed and load to be carried must be taken into account. The following table shows detailed information of the different oils and their specifications:

Type of oil	Synthetic oils					
	Mineral oils	Polyglycols	Polyalphaolefines	Esters	Silicone oils	Fluorated
Viscosity 40°C (mm <sup>2</sup> /sg)	2 / 4500	20 / 2000	15 / 1500	7 / 4000	4 / 100000	20 / 650
Temperature (°C)	-50 / 170	-50 / 200	-20 / 160	-60 / 120	-70 / 200	-60 / 250
Loads	3	3	3	2	1	2
High speed	2	2	2	3	2	2
Rusting	1	3	2	3	2	3

1- Regular resistance    2- Good resistance    3- Very good resistance

An oil lubricant should be chosen according to the required viscosity in order to guarantee an adequate lubrication in relation to the working temperature.

The time lapse from functioning to fatigue and protection from wear is best when the contact surfaces are well separated by the lubricant. Because the thickness of the lubricant layer increases with the oil viscosity, in theory oil with high viscosity should be chosen for the application. However, as the viscosity increases so does the friction of the lubricant, so the oil lubricant chosen should have enough viscosity to sustain the fatigue, while at the same time providing enough oil lubrication for the bearings.

There is a certain K relation between the viscosity ( $\nu$ ) of the selected oil to the temperature when the bearing is functioning, and the necessary cinematic speed  $v_1$  for a satisfactory lubrication.

### 5.3.4 - Lubrication processes-oil

If an excessive amount of oil is used, the cooling level is good, but friction increases. For this situation there are different lubrication systems:

- **Oil bath or immersion:** A simple method for low speeds. When not moving, the bath should cover half of the lower part of the rolling element, so that when it rotates the oil is distributed on all of the parts. The oil level should be checked periodically and replaced according to contamination and wear (especially when temperatures are high and if oxygen and abrasives are present). This should be done every two months.

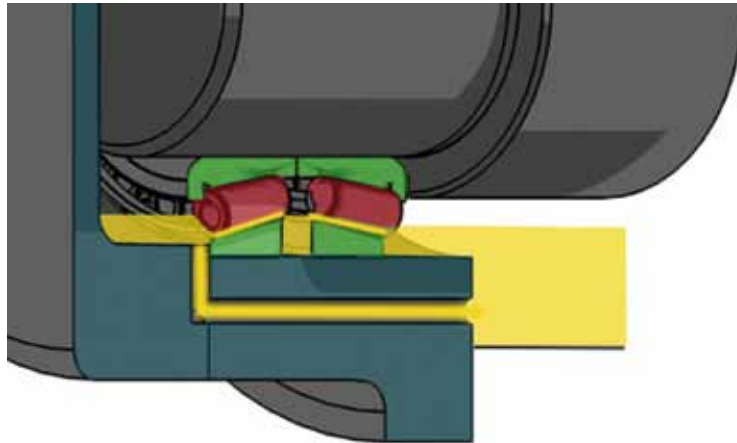

Oil bath

- **Oil circulation:** Oil is brought to the bearing from a deposit by a system of pumps, tubes and valves. The bearing should be lubricated before being operative and the amount of oil depends on the working conditions and the size of the bearing (more or less, between 0, 5 and 50 l/m). This procedure in combination with the oil bath greatly improves the bearing's features.

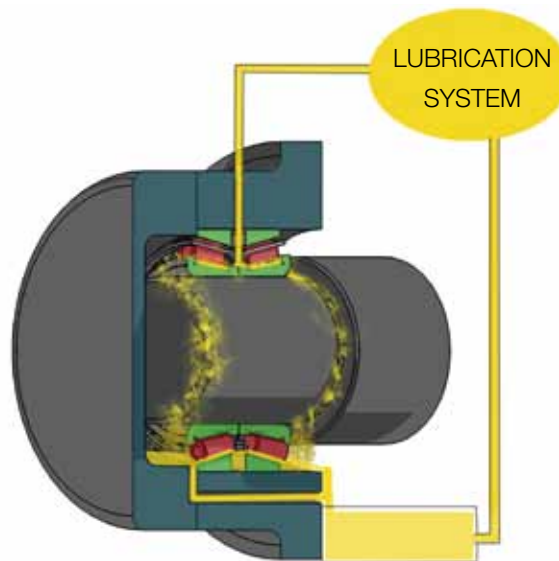

Oil circulation



- **Injection of oil:** at high speed (at least 15 m/s). It is advisable to inject the oil in the direction of the bearing.

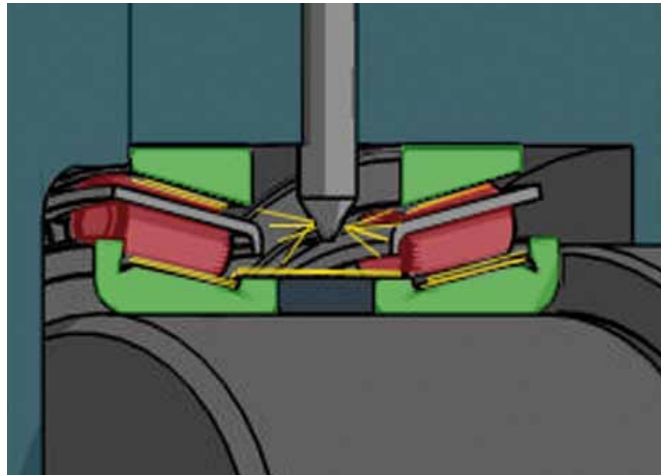

Injection of oil

With small quantities of oil (10 mg / h), using a lubrication system through a drip, oil mist or transported through the air, which results in a more precise lubrication, therefore forming a film between the contact surfaces which decreases the friction and maintains a low temperature.

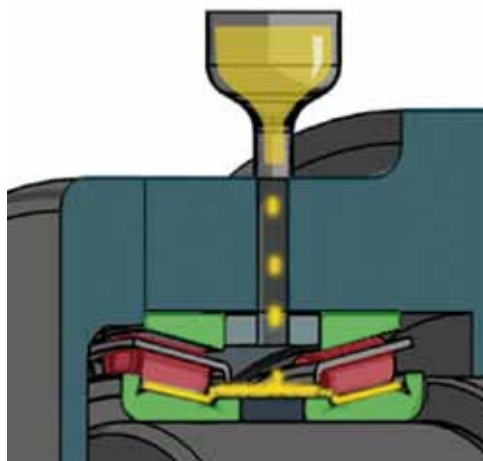

Lubrication by dripping

# 06/ Sealing

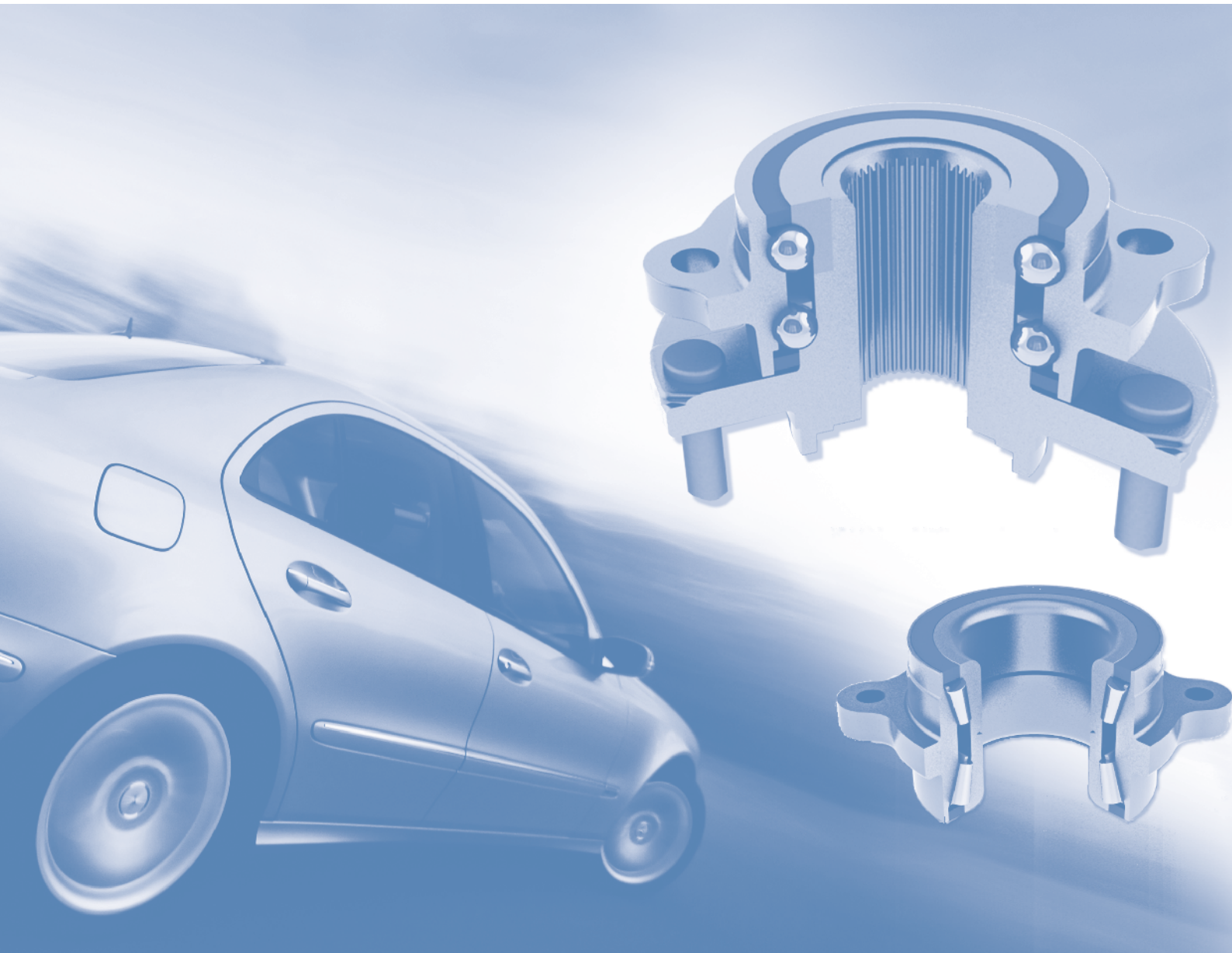



## 06 Sealing

---

<b>6.1 - Definition</b>	<b>56</b>
<b>6.2 - Sealing elements</b>	<b>56</b>

---

# Sealing

## 6.1 - Definition

Given certain applications, the mounted bearings must be protected with sealing mechanisms. These mechanisms must carry out two basic functions:

- Prevent external dirt or humidity from entering.
- Prevent lubricants from leaking out.

The service life of the bearings very often depends on the efficiency of these mechanisms. The sealing mechanisms may vary a lot, and various factors must be considered when choosing the one to be applied:

- Type of lubricant (oil or grease).
- Rotation speed.
- Available space.
- Seal friction.
- Cost, etc.

Concerning the sealing function, if the two mechanical parts between which the leakage is likely to occur are fixed with relation to each other, the seal is called a static seal. If one or both of these parts are moving relative to the other, the seal is called a dynamic seal.

Many different methods have been or are still used for sealing, such as:

- |   |  |
|---|--|
| - With contact  | - Contactless  |
| <ul style="list-style-type: none"> <li>• Felt rings</li> <li>• Oil lip seals</li> </ul> | <ul style="list-style-type: none"> <li>• Oil grooves</li> <li>• Deflecting ring</li> <li>• Labyrinth glands</li> </ul> |

## 6.2 - Sealing Elements

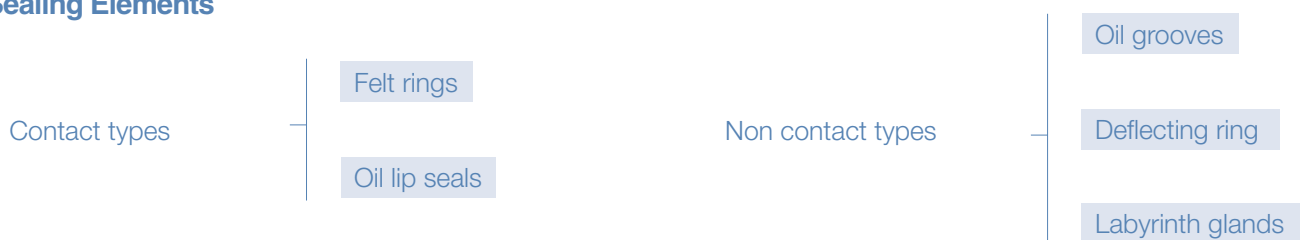

## Felt rings

- Simple and widely used.
- Suitable for lubrication with grease.
- Speed limit: 3-5 m/sec.
- Not suitable for high speeds or high temperatures.
- Best performance when several felt rings are used together and in combination.
- Suitable in cases without excessive dirt.

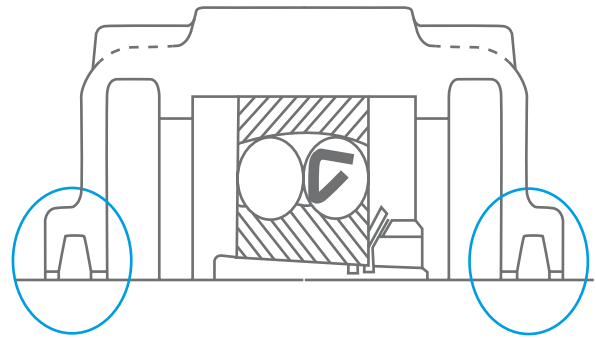

## Retainers for oil and grease

- Oil lip seals.
- Standard parts. A large variety of types and sizes.
- Capacity to tolerate axle misalignment.
- The axle must have an appropriate finish and hardness.
- The sealing is a result of the lubrication film between the retainer and the axle.
- Appropriate thickness of the film must be maintained.
- Speed limit: 10-18 m/sec.
- Be careful when installing.

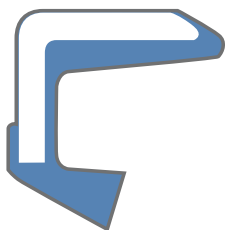
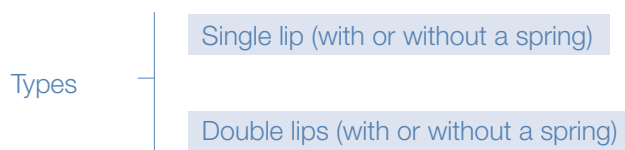

One lip without spring



One lip with spring

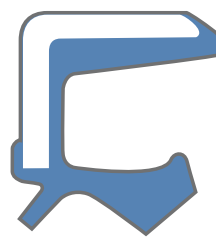

Double lips without spring

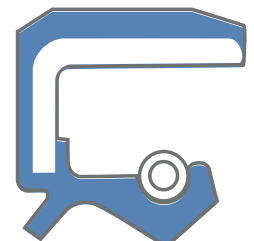

Double lips with spring



### Oil grooves

- Oil grooves in shafts, housing or both. They can have a helicoidal shape (applications with only one direction of shaft rotation) so that they can function as lubrication pumps.
- Particularly well suited in cases of low grease and low speed.
- The space between the shaft and housing should be as small as possible.
  - ⎧ O shaft < 50 mm → 0, 25 – 0, 4 mm.
  - ⎨ O shaft > 50 mm → 0, 5- 1 mm.
- Width: 2-5 mm / Depth: 4-5 mm.
- They are frequently used in combination with other sealing elements. Performance can be improved if filled with groove grease.

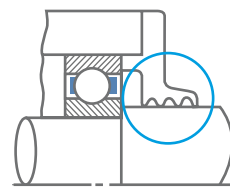

Groove in the box

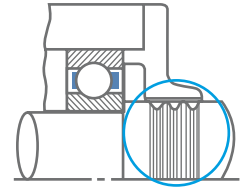

Groove in the axis

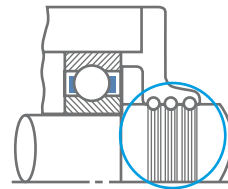

Groove in the box and axis

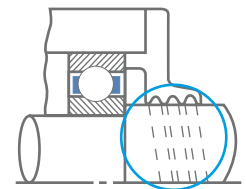

Helicoidal groove

### Deflecting ring

- Prevents the flow of particles and entry of dirt by centrifugal force and air flow.
- Used frequently in combination with other sealing elements.
- Limits speed: 10 - 18 m/sec.

Types

- Installed inside the box: the lubricant is introduced through a pump preventing leaks.
- Installed outside the box: prevents the entry of foreign materials into the housing.
- Type of cover: it removes the dirt by a centrifugal force.
- Forms a labyrinth with the box: the lubricant is introduced through a pump, preventing leaks.

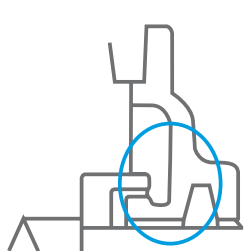

Inside the box

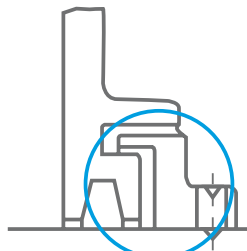

Outside the box

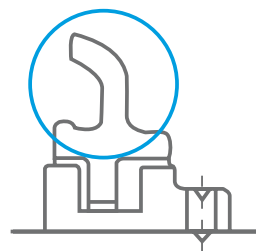

Labyrinth

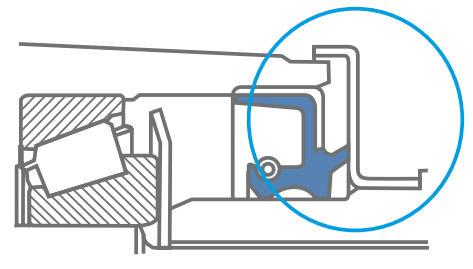

Lid

## Labyrinths

- The most suitable sealing system for high speeds (no friction).
- The number of grooves varies. If the number is increased, the labyrinth is more effective (less likely to have a leak).
- Its effect can be improved by filling them with grease
- Recommended measurement (mm).

$\left\{ \begin{array}{l} \text{Ø shaft} < 50 \text{ mm} \rightarrow \text{Radial: } 0.25\text{--}0.4 / \text{Axial: } 1\text{--}2 \\ \text{Ø shaft} > 50 \text{ mm} \rightarrow \text{Radial } 0.5\text{--}1 / \text{Axial: } 3\text{--}5 \end{array} \right.$

Types  $\left\{ \begin{array}{l} \text{Axial: for single housing} \\ \text{Radial: for complex housing} \end{array} \right.$ 

 $\left\{ \begin{array}{l} \text{Attention: Can be oblique if you wait for a considerable} \\ \text{misalignment between the axle and housing} \end{array} \right.$

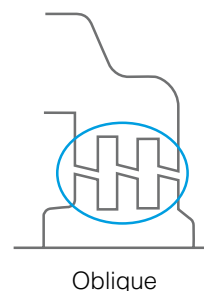
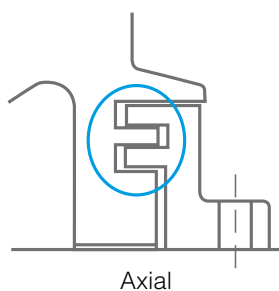
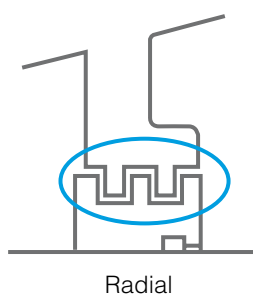

# 07/ Application list

## Wheel bearing kits by brands

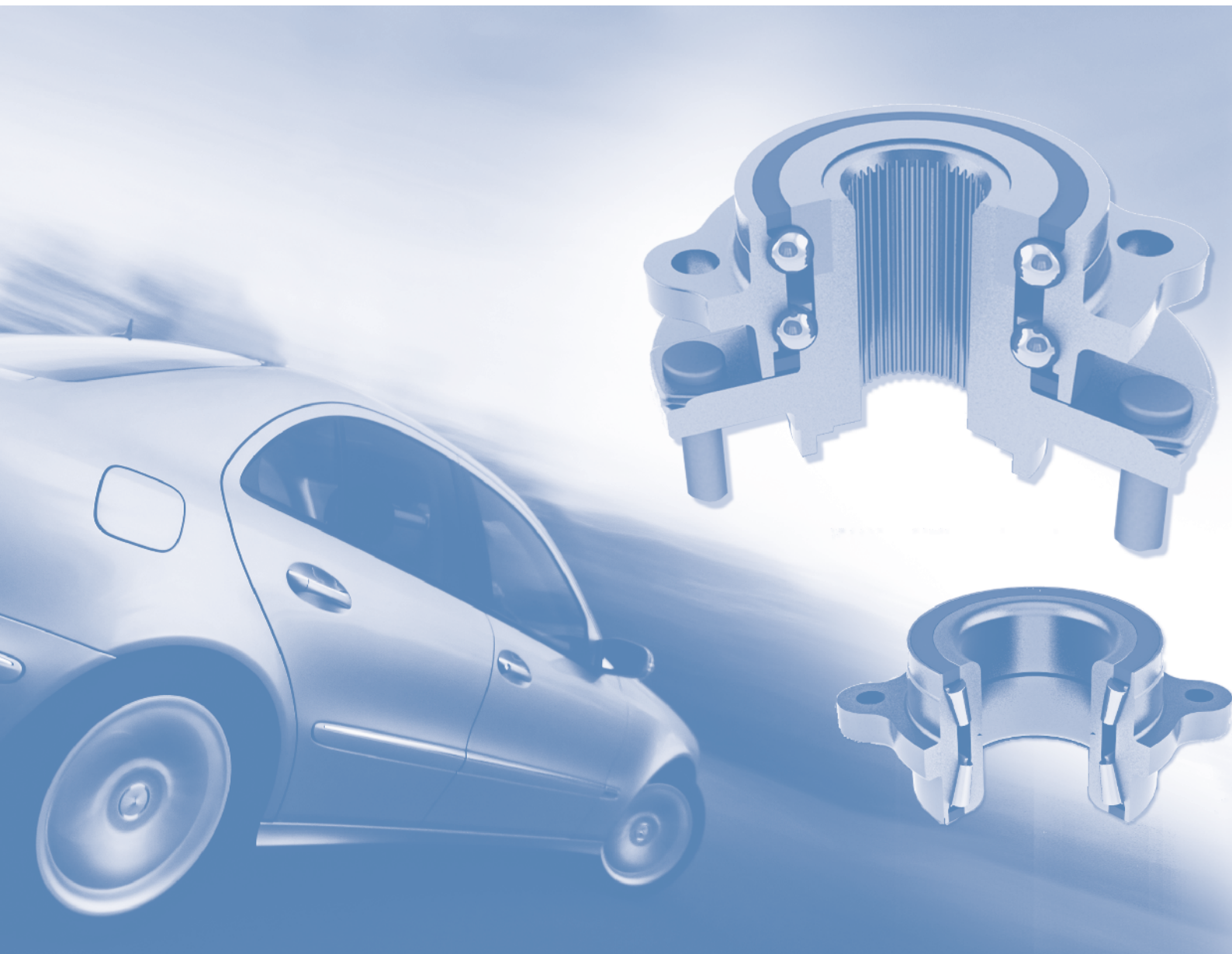



## 07 Application list wheel bearing kits by brands

---

<b>ALFA ROMEO</b>	<b>62</b>	<b>MAZDA</b>	<b>121</b>
<b>AUDI</b>	<b>66</b>	<b>MERCEDES BENZ</b>	<b>123</b>
<b>AUSTIN</b>	<b>76</b>	<b>MG</b>	<b>130</b>
<b>AUTOBIANCHI</b>	<b>76</b>	<b>MITSUBISHI</b>	<b>130</b>
<b>BMW</b>	<b>76</b>	<b>NISSAN</b>	<b>132</b>
<b>CITROËN</b>	<b>80</b>	<b>OPEL</b>	<b>135</b>
<b>DACIA</b>	<b>90</b>	<b>PEUGEOT</b>	<b>151</b>
<b>DAEWOO</b>	<b>91</b>	<b>PORCHE</b>	<b>162</b>
<b>DAF</b>	<b>91</b>	<b>RENAULT</b>	<b>162</b>
<b>DAIHATSU</b>	<b>91</b>	<b>ROVER</b>	<b>176</b>
<b>FIAT</b>	<b>92</b>	<b>SAAB</b>	<b>177</b>
<b>FORD</b>	<b>104</b>	<b>SEAT</b>	<b>178</b>
<b>FSO</b>	<b>114</b>	<b>SKODA</b>	<b>180</b>
<b>HONDA</b>	<b>114</b>	<b>SUZUKI</b>	<b>181</b>
<b>HYUNDAI</b>	<b>116</b>	<b>TALBOT</b>	<b>182</b>
<b>IVECO</b>	<b>117</b>	<b>TOYOTA</b>	<b>183</b>
<b>KIA</b>	<b>117</b>	<b>VAUXHALL</b>	<b>185</b>
<b>LADA</b>	<b>118</b>	<b>VOLKSWAGEN</b>	<b>198</b>
<b>LANCIA</b>	<b>118</b>	<b>VOLVO</b>	<b>207</b>
<b>LAND ROVER</b>	<b>120</b>	<b>ZASTAVA</b>	<b>213</b>

---

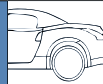
	<b>i</b>	ENGINE	POWER (kW)	YEAR	<b>i</b>	
Fersa KIT FRONT						Fersa KIT REAR
<b>ALFA ROMEO</b>						
<b>6 (119)</b>						
<b>KA 004</b>		2.0; 2.5 i.e.	99-116	04.79-12.86		
<b>KA 004</b>		2.5 TD	77	07.81-05.86		
<b>33 (905)</b>						
		1.2; 1.3; 1.3 i.e.; 1.5	50-66	05.83-12.89		<b>KA 001</b>
<b>KF 094</b>	01.90 -->	1.5	70	05.83-12.93		
		1.5	70	05.83-12.93		<b>KA 001</b>
		1.5; 1.5 QV	75-77	06.84-12.89		<b>KA 001</b>
		1.7; 1.7 i.e.; 1.7 QV	77-95	01.86-12.89		<b>KA 001</b>
<b>KF 094</b>	01.90 -->	1.8 TD	54	01.86-06.90		
		1.8 TD	54	01.86-06.90		<b>KA 001</b>
<b>33 (905A)</b>						
		1.4; 1.5	66-77	01.84-12.89		<b>KA 001</b>
		1.7 i.e.	77	09.88-12.89		<b>KA 001</b>
		1.7	87	03.88-12.89		<b>KA 001</b>
		1.8 TD	62	01.86-12.89		<b>KA 001</b>
<b>33 (907A)</b>						
<b>KF 094</b>		1.4; 1.4 i.e.; 1.5; 1.5 i.e.; 1.7 16V; 1.7 i.e.	58-101	01.90-09.94	DRUM BRAKE	<b>KA 001</b>
<b>KF 094</b>		1.7 16V 4x4; 1.7 i.e. 4x4	79-101	01.90-09.94		
<b>KF 094</b>		1.8 TD	62	07.90-09.94	DRUM BRAKE	<b>KA 001</b>
<b>33 (907B)</b>						
<b>KF 094</b>		1.4 i.e.	65-66	06.91-09.94	DRUM BRAKE	<b>KA 001</b>
<b>KF 094</b>		1.4 i.e. 4x4	66	06.91-09.94		
<b>KF 094</b>		1.5 i.e.; 1.7 16V; 1.7 i.e.	71-101	01.90-09.94	DRUM BRAKE	<b>KA 001</b>
<b>KF 094</b>		1.7 16V 4x4; 1.7 i.e. 4x4	79-97	01.90-09.94		
<b>75 (162B)</b>						
<b>KA 003</b>		1.6	81	05.85-09.89		
<b>KA 003</b>		1.6	81	05.85-09.89	RIGHT WHEEL / 10.85 -->	<b>KF 092</b>
<b>KA 003</b>		1.6	81	05.89-02.92	RIGHT WHEEL	<b>KF 092</b>
<b>KA 003</b>		1.6	81	05.89-02.92		
<b>KA 003</b>		1.6	76	05.85-09.89		
		1.6	76	05.85-09.89	RIGHT WHEEL / 10.85 -->	<b>KF 092</b>
<b>KA 003</b>		1.8; 1.8 TURBO; 1.8 TURBO i.e.	85-114	09.85-02.92		
<b>KA 003</b>		1.8; 1.8 TURBO; 1.8 TURBO i.e.	85-114	09.85-02.92		<b>KF 092</b>
<b>KA 003</b>		1.8; 1.8 Turbo ; 2.0	85-114	84-93		<b>KF 093</b>
<b>KA 004</b>		2.0; 2.5; 3.0	94	10.85-94		<b>KF 093</b>
<b>KA 003</b>		2.0	94	05.85-10.88		
		2.0	94	05.85-10.88	RIGHT WHEEL / 10.85 -->	<b>KF 092</b>
<b>KA 003</b>		2.0 T.S.	107	01.87-02.92		
<b>KA 003</b>		2.0 T.S.	107	01.87-02.92	RIGHT WHEEL	<b>KF 092</b>
<b>KA 003</b>		2.0 T.S.	109	05.85-02.92		
		2.0 T.S.	109	05.85-02.92	RIGHT WHEEL / 10.85 -->	<b>KF 092</b>
<b>KA 003</b>		2.0 T.S.; 2.5 V6	109-113	09.86-04.89		
<b>KA 003</b>		2.0 T.S.; 2.5 V6	109-113	09.86-04.89	RIGHT WHEEL	<b>KF 092</b>
<b>KA 003</b>		2.5; 3.0; 2.4 TD	115	10.85-94		<b>KF 093</b>
<b>KA 003</b>		2.5 V6	115	05.85-08.86		
		2.5 V6	115	05.85-08.86	RIGHT WHEEL / 10.85 -->	<b>KF 092</b>
<b>KA 003</b>		3.0 V6	136-141	01.87-02.92		
<b>KA 003</b>		3.0 V6	136-141	01.87-02.92	RIGHT WHEEL	<b>KF 092</b>
<b>KA 003</b>		2.0 TD	70	05.85-09.92		
		2.0 TD	70	05.85-09.92	RIGHT WHEEL / 10.85 -->	<b>KF 092</b>
<b>KA 003</b>		2.4 TD	82	01.89-02.92		



	<b>i</b>	<b>ENGINE</b>	<b>POWER (kW)</b>	<b>YEAR</b>	<b>i</b>	
Fersa KIT FRONT						Fersa KIT REAR
<b>ALFA ROMEO</b>						
<b>75 (162B)</b>						
<b>KA 003</b>		2.4 TD	82	01.89-02.92	RIGHT WHEEL	<b>KF 092</b>
<b>90 (162)</b>						
<b>KA 003</b>		1.6; 1.6 Turbo	85-114	84-93		<b>KF 093</b>
<b>KA 003</b>		1.8; 2.0; 2.5	85-114	84-90		<b>KF 093</b>
<b>KA 003</b>		1.8; 2.0 i.e.; 2.5 i.e. V6	85-114	10.84-07.87		
		1.8; 2.0 i.e.; 2.5 i.e. V6	85-114	10.84-07.87	RIGHT WHEEL / 10.85 -->	<b>KF 092</b>
<b>KA 003</b>		2.4; 2.4 TD	85-114	84-88		<b>KF 093</b>
<b>KA 003</b>		GTV 2.0 RTD; RTI	85-114	85-87		<b>KF 093</b>
<b>KA 003</b>		2.4 TD	81	10.84-07.87		
<b>KA 003</b>		2.4 TD	81	10.84-07.87	RIGHT WHEEL / 10.85 -->	<b>KF 092</b>
<b>145 (930)</b>						
<b>KF 166</b>	<b>ABS</b>	1.4 i.e.	66	07.94-12.96	<b>ABS</b>	<b>KV 164</b>
<b>KF 166</b>	ABS	1.4 i.e.	66	07.94-12.96	ABS / --> 01.96	<b>KV 218</b>
<b>KF 166</b>	ABS	1.4 i.e.	66	07.94-12.96	ABS / 02.96 -->	<b>KV 237</b>
<b>KF 166</b>	ABS / --> 12.98	1.4 i.e. 16V T.S.	76	12.96-01.01	ABS / --> 12.98	<b>KV 237</b>
<b>KF 283</b>	ABS / 01.99 -->	1.4 i.e. 16V T.S.	76	12.96-01.01	ABS / 01.99 -->	<b>KV 251</b>
<b>KF 166</b>	<b>ABS</b>	1.4 i.e. 16V T.S.	76	12.96-01.01	<b>ABS</b>	<b>KV 164</b>
<b>KF 166</b>	<b>ABS</b>	1.6 i.e.	76	10.94-12.96	<b>ABS</b>	<b>KV 164</b>
<b>KF 166</b>	ABS	1.6 i.e.	76	10.94-12.96	ABS / --> 01.96	<b>KV 218</b>
<b>KF 166</b>	ABS	1.6 i.e.	76	10.94-12.96	ABS / 02.96 -->	<b>KV 237</b>
<b>KF 166</b>	ABS / --> 12.98	1.6 i.e. 16V T.S.	88	12.96-01.01	ABS / --> 12.98	<b>KV 237</b>
<b>KF 283</b>	ABS / 01.99 -->	1.6 i.e. 16V T.S.	88	12.96-01.01	ABS / 01.99 -->	<b>KV 251</b>
<b>KF 166</b>	<b>ABS</b>	1.6 i.e. 16V T.S.	88	12.96-01.01	<b>ABS</b>	<b>KV 164</b>
<b>KF 166</b>	ABS	1.7 i.e. 16V	95	10.94-12.96	ABS / --> 01.96	<b>KV 218</b>
<b>KF 166</b>	ABS	1.7 i.e. 16V	95	10.94-12.96	ABS / 02.96 -->	<b>KV 237</b>
<b>KF 166</b>	<b>ABS</b>	1.7 i.e. 16V	95	10.94-12.96	<b>ABS</b>	<b>KV 164</b>
<b>KF 166</b>	ABS	1.8 i.e. 16V T.S.	103	12.96-12.98	ABS	<b>KV 237</b>
<b>KF 166</b>	<b>ABS</b>	1.8 i.e. 16V T.S.	103	12.96-12.98	<b>ABS</b>	<b>KV 164</b>
<b>KF 166</b>	ABS / --> 12.98	1.8 i.e. 16V; 2.0 16V Quadrifoglio; 2.0 16V T.S.	106-114	10.95-01.01	ABS / --> 12.98	<b>KV 237</b>
<b>KF 283</b>	ABS / 01.99 -->	1.8 i.e. 16V; 2.0 16V Quadrifoglio; 2.0 16V T.S.	106-114	10.95-01.01	ABS / 01.99 -->	<b>KV 251</b>
<b>KF 166</b>	<b>ABS</b>	1.8 i.e. 16V; 2.0 16V Quadrifoglio; 2.0 16V T.S.	106-114	10.95-01.01	<b>ABS</b>	<b>KV 164</b>
		1.9 JTD	77	02.99-01.01	ABS	<b>KV 251</b>
<b>KF 264</b>	<b>ABS</b>	1.9 JTD	77	02.99-01.01	<b>ABS</b>	<b>KV 164</b>
<b>KF 166</b>	<b>ABS</b>	1.9 TD	66	10.94-02.99	<b>ABS</b>	<b>KV 164</b>
<b>KF 166</b>	ABS	1.9 TD	66	10.94-02.99	ABS / --> 01.96	<b>KV 218</b>
<b>KF 166</b>	ABS	1.9 TD	66	10.94-02.99	ABS / 02.96 -->	<b>KV 237</b>
<b>146 (930)</b>						
<b>KF 166</b>	<b>ABS</b>	1.4 i.e.	66	12.94-12.96	<b>ABS</b>	<b>KV 164</b>
<b>KF 166</b>	ABS	1.4 i.e.	66	12.94-12.96	ABS / --> 01.96	<b>KV 218</b>
<b>KF 166</b>	ABS	1.4 i.e.	66	12.94-12.96	ABS / 02.96 -->	<b>KV 237</b>
<b>KF 166</b>	ABS / --> 09.98	1.4 i.e. 16V T.S.	76	11.96-01.01	ABS / --> 09.98	<b>KV 237</b>
<b>KF 283</b>	ABS / 10.98 -->	1.4 i.e. 16V T.S.	76	11.96-01.01	ABS / 10.98 -->	<b>KV 251</b>
<b>KF 166</b>	<b>ABS</b>	1.4 i.e. 16V T.S.	76	11.96-01.01	<b>ABS</b>	<b>KV 164</b>
<b>KF 166</b>	<b>ABS</b>	1.6 i.e.	76	12.94-12.96	<b>ABS</b>	<b>KV 164</b>
<b>KF 166</b>	ABS	1.6 i.e.	76	12.94-12.96	ABS / --> 01.96	<b>KV 218</b>
<b>KF 166</b>	ABS	1.6 i.e.	76	12.94-12.96	ABS / 02.96 -->	<b>KV 237</b>
<b>KF 166</b>	ABS / --> 09.98	1.6 i.e. 16V T.S.	88	11.96-01.01	ABS / --> 09.98	<b>KV 237</b>
<b>KF 283</b>	ABS / 10.98 -->	1.6 i.e. 16V T.S.	88	11.96-01.01	ABS / 10.98 -->	<b>KV 251</b>
<b>KF 166</b>	<b>ABS</b>	1.6 i.e. 16V T.S.	88	11.96-01.01	<b>ABS</b>	<b>KV 164</b>
<b>KF 166</b>	<b>ABS</b>	1.7 i.e. 16V	95	12.94-12.96	<b>ABS</b>	<b>KV 164</b>

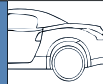

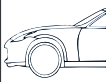
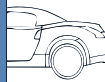
	<b>i</b>	ENGINE	POWER (kW)	YEAR	<b>i</b>	
Fersa KIT FRONT						Fersa KIT REAR
<b>ALFA ROMEO</b>						
<b>146 (930)</b>						
<b>KF 166</b>	ABS	1.7 i.e. 16V	95	12.94-12.96	ABS / --> 01.96	<b>KV 218</b>
<b>KF 166</b>	ABS	1.7 i.e. 16V	95	12.94-12.96	ABS / 02.96 -->	<b>KV 237</b>
<b>KF 166</b>	ABS / --> 09.98	1.8 i.e. 16V T.S.	103	11.96-01.01	ABS / --> 09.98	<b>KV 237</b>
<b>KF 283</b>	ABS / 10.98 -->	1.8 i.e. 16V T.S.	103	11.96-01.01	ABS / 10.98 -->	<b>KV 251</b>
<b>KF 166</b>	<del>ABS</del>	1.8 i.e. 16V T.S.	103	11.96-01.01	<del>ABS</del>	<b>KV 164</b>
<b>KF 166</b>	ABS / --> 12.98	1.8 i.e. 16V T.S.	106	03.98-01.01	ABS / --> 12.98	<b>KV 237</b>
<b>KF 283</b>	ABS / 01.99 -->	1.8 i.e. 16V T.S.	106	03.98-01.01	ABS / 01.99 -->	<b>KV 251</b>
<b>KF 166</b>	ABS	1.8 i.e. 16V T.S.	106	03.98-01.01	<del>ABS</del>	<b>KV 164</b>
<b>KF 166</b>	ABS / --> 09.98	2.0 16V T.S.	110	10.95-01.01		
<b>KF 283</b>	ABS / 10.98 -->	2.0 16V T.S.	110	10.95-01.01		
<b>KF 166</b>	<del>ABS</del>	2.0 16V T.S.	110	10.95-01.01	<del>ABS</del>	<b>KV 164</b>
<b>KF 166</b>	ABS	2.0 16V T.S.	110	10.95-01.01	ABS / --> 01.96	<b>KV 218</b>
<b>KF 166</b>	ABS	2.0 16V T.S.	110	10.95-01.01	ABS / 02.96 --> / --> 07.98	<b>KV 237</b>
<b>KF 166</b>	ABS	2.0 16V T.S.	110	10.95-01.01	ABS / 08.98 -->	<b>KV 251</b>
<b>KF 166</b>	ABS / --> 09.98	2.0 16V Quadrifoglio	114	03.98-01.01	ABS / --> 09.98	<b>KV 237</b>
<b>KF 283</b>	ABS / 10.98 -->	2.0 16V Quadrifoglio	114	03.98-01.01	ABS / 10.98 -->	<b>KV 251</b>
<b>KF 166</b>	<del>ABS</del>	2.0 16V Quadrifoglio	114	03.98-01.01	<del>ABS</del>	<b>KV 164</b>
		1.9 JTD	77	02.99-01.01	ABS	<b>KV 251</b>
<b>KF 264</b>	<del>ABS</del>	1.9 JTD	77	02.99-01.01	<del>ABS</del>	<b>KV 164</b>
<b>KF 166</b>	ABS / --> 09.98	1.9 TD	66	12.94-02.99		
<b>KF 283</b>	ABS / 10.98 -->	1.9 TD	66	12.94-02.99		
<b>KF 166</b>	<del>ABS</del>	1.9 TD	66	12.94-02.99	<del>ABS</del>	<b>KV 164</b>
<b>KF 166</b>	ABS	1.9 TD	66	12.94-02.99	ABS / --> 01.96	<b>KV 218</b>
<b>KF 166</b>	ABS	1.9 TD	66	12.94-02.99	ABS / 02.96 --> / --> 07.98	<b>KV 237</b>
<b>KF 166</b>	ABS	1.9 TD	66	12.94-02.99	ABS / 08.98 -->	<b>KV 251</b>
<b>155 (167)</b>						
<b>KF 166</b>	ABS	1.6 16V T.S.; 1.7 16V T.S.; 1.7 T.S.; 1.8 T.S.; 1.8 T.S. SPORT; 2.0 16V T.S.; 2.0 T.S.	77-110	01.92-12.97	ABS	<b>KV 164</b>
<b>KF 166</b>		1.6 16V T.S.; 1.7 16V T.S.; 1.7 T.S.; 1.8 T.S.; 1.8 T.S. SPORT; 2.0 16V T.S.; 2.0 T.S.	77-110	01.92-12.97	ABS	<b>KV 218</b>
<b>KF 264</b>	ABS	2.0 16V TURBO Q4; 2.5 V6	120-140	01.92-12.97	ABS	<b>KV 164</b>
<b>KF 264</b>		2.0 16V TURBO Q4; 2.5 V6	120-140	01.92-12.97	ABS	<b>KV 218</b>
<b>KF 166</b>	ABS	1.9 TD	66	04.93-12.97	ABS	<b>KV 164</b>
<b>KF 166</b>		1.9 TD	66	04.93-12.97	ABS	<b>KV 218</b>
<b>KF 264</b>		2.5 TD	92	04.93-12.97	<del>ABS</del>	<b>KV 164</b>
<b>KF 264</b>		2.5 TD	92	04.93-12.97	ABS	<b>KV 218</b>
<b>164 (164)</b>						
<b>KF 261</b>	CH. --> 0014991	2.0	102	06.87-09.98		
<b>KF 264</b>	CH. 0014992 -->	2.0	102	06.87-09.98		
<b>KF 261</b>		2.0 T.S.	105	06.87-09.92		
<b>KF 264</b>	01.90 -->	2.0 T.S.	105	06.87-09.92		
<b>KF 261</b>	--> 11.93/ CH. --> 0014991	2.0 T.S.	106	09.92-09.98		
<b>KF 264</b>	12.93 --> / CH. 0014992 -->	2.0 T.S.	106	09.92-09.98		
<b>KF 261</b>		2.0 T.S.	109	06.87-12.90		
<b>KF 264</b>	01.90 -->	2.0 T.S.	109	06.87-12.90		
<b>KF 264</b>		2.0 TURBO	128	10.87-09.98		
<b>KF 264</b>		2.0 V6 TURBO	148	09.92-09.98		
<b>KF 264</b>		2.0 V6 TURBO	150	03.91-09.92		
<b>KF 264</b>		2.5 V6	120	09.92-09.98		
<b>KF 264</b>		3.0 V6	132	09.92-09.98		

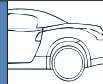
	<b>i</b>	ENGINE	POWER (kW)	YEAR	<b>i</b>	
Fersa KIT FRONT						Fersa KIT REAR
<b>ALFA ROMEO</b>						
<b>164 (164)</b>						
<b>KF 264</b>		3.0 i.e. QV; 3.0 V6	135-147	06.87-09.92		
<b>KF 264</b>		3.0 24V; 3.0 24V QV	155-171	09.92-09.98		
<b>KF 264</b>		3.0 24V Q4	170	02.94-09.98		<b>KF 264</b>
<b>KF 264</b>		2.5 TD	92	09.92-09.98		
<b>KF 264</b>		2.5 TD	84	06.87-09.92		
<b>ALFASUD (901,902,904)</b>						
		1.2; 1.2 ti; 1.3; 1.3 SC/ti SUPER; 1.3 SUPER; 1.3 ti; 1.4; 1.5;	44-87	06.72-12.89	DRUM BRAKE	<b>KA 001</b>
<b>ALFASUD SPRINT</b>						
<b>KF 092</b>		ALFASUD SPRINT	44-87	85-87		<b>KA 001</b>
<b>ALFETTA (116)</b>						
<b>KA 001</b>		1.6, 1.8, 2.0	79	76-03.80		
<b>KA 002</b>	--> 12.76	1.6	79	01.75-12.84		
<b>KA 003</b>	03.80 -->	1.6	79	01.75-12.84		
<b>KA 002</b>	--> 12.76	1.8	85	07.74-12.77		
<b>KA 003</b>	03.80 -->	1.8	89-90	10.79-12.84		
<b>KA 003</b>	03.80 -->	2.0	97	07.78-12.84		
<b>KA 003</b>	03.80 -->	2.0 TD	60	10.79-03.83		
<b>KA 003</b>		2.4 TD	70	04.83-12.84		
<b>KA 002</b>	--> 12.76	1.6	79	01.76-09.82		
<b>KA 003</b>	03.80 -->	1.6	79	01.76-09.82		
<b>KA 002</b>		1.8	85-89	01.74-12.76		
<b>KA 003</b>	03.80 -->	2.0	89-96	06.77-01.86		
<b>ARNA (920)</b>						
		1.2; 1.3; 1.3 T; 1.5	44-70	03.83-12.86		<b>KA 077</b>
<b>GIULIETTA (116)</b>						
<b>KA 001</b>		1.3,1.4,1.6,1.8,2.0	66	78-02.80		
<b>KA 003</b>	03.80 -->	1.3; 1.6; 1.8	66-90	10.77-04.85		
<b>KA 003</b>		1.8 TURBO; 2.0; 2.0 TURBO	96-125	06.80-12.85		
<b>KA 003</b>		2.0 TD	61	01.83-12.85		
<b>GTV (116)</b>						
<b>KA 003</b>		2.0; 2.0 Turbodelta	94-111	01.78-01.86		
<b>KA 003</b>		2.0; 2.0 Turbodelta	94-111	01.78-01.86	RIGHT WHEEL	<b>KF 092</b>
<b>KA 003</b>		6 2,5	116	11.80-02.87	RIGHT WHEEL / 01.85 -->	<b>KF 092</b>
<b>GTV6</b>						
<b>KA 003</b>		GTV6 2.5 RTD	116	81-84		<b>KF 093</b>
<b>KA 003</b>		GTV6 2.5 RTI	116	81-84		<b>KF 093</b>
<b>KA 003</b>		GTV6 2.5 RTD	116	85-87		<b>KF 093</b>
<b>KA 003</b>		GTV6 2.5 RTI	116	85-87		<b>KF 093</b>
<b>GTV (916C_)</b>						
<b>KF 166</b>	--> VIN. 6063040	1.8 16V; 2.0 16V; 2.0 16V T.S.; 2.0 V6 TURBO; 3.0 V6 24V	106-162	06.95-		
<b>SPIDER (916S_)</b>						
<b>KF 166</b>	--> VIN. 6063040	1.8 16V; 2.0 T.S. 16V	106-110	06.95-04.05		
<b>KF 283</b>	ABS / VIN.6063041 -->	1.8 16V; 2.0 T.S. 16V	106-110	06.95-04.05		
<b>KF 166</b>	--> VIN. 6063040	2.0 T.S. 16V	114	05.98-08.00		
<b>KF 264</b>	--> VIN. 6063040	2.0 V6 Turbo; 3.0 V6	141-148	06.95-04.05		

	<b>i</b>	ENGINE	POWER (kW)	YEAR	<b>i</b>	
Fersa KIT FRONT						Fersa KIT REAR
<b>AUDI</b>						
<b>50 (86)</b>						
<b>KF 180</b>		1.1; 1.3	37-44	08.74-07.78		<b>KA 006</b>
<b>60</b>						
		1.5	40	10.68-09.73		<b>KA 006</b>
		1.5; 1.7; 1.7 L	40-55	09.68-09.73		<b>KA 006</b>
<b>80 (80,82,B1)</b>						
<b>KF 095</b>	CH --> 89-J-373598	1.3; 1.5; 1.6 GT	40-74	05.72-07.78		
		1.3; 1.5; 1.6 GT	40-74	05.72-07.78		<b>KA 006</b>
<b>KF 095</b>		1.6	55-81	74-04.88		<b>KA 069</b>
<b>KF 096</b>	DRUM BRAKE	1.6,1.8,1.9,2.0	55-81	90-92		<b>KA 069</b>
<b>KF 095</b>		1.6; 1.6 GTE	55-81	09.75-07.78		
		1.6; 1.6 GTE	55-81	09.75-07.78	DRUM BRAKE	<b>KA 006</b>
<b>KF 095</b>		1.6; 1.6 GTE	55-81	09.75-07.78	DRUM BRAKE	<b>KA 006</b>
<b>KF 096</b>		1.6 D, TD	40-44	82-92		<b>KA 069</b>
<b>80 (81,85,B2)</b>						
<b>KF 095</b>		1.3	40-44	09.78-07.81	DRUM BRAKE	<b>KA 006</b>
<b>KF 095</b>		1.3; 1.6; 1.6 GLE; 1.8; 1.8 GTE	44-82	08.78-12.86	DISC BRAKE	<b>KA 005</b>
<b>KF 095</b>		1.3; 1.6; 1.6 GLE; 1.8; 1.8 GTE	44-82	08.78-12.86	DRUM BRAKE	<b>KA 006</b>
<b>KF 095</b>		1.8 CC QUATTRO; 1.8 GTE QUATTRO	66-82	08.84-08.86		
<b>KF 095</b>		1.9 CD-5S; 2.0	85	09.81-09.84	DISC BRAKE	<b>KA 005</b>
<b>KF 096</b>		1.9 D, TD	85	90-92		<b>KA 069</b>
<b>KF 096</b>	DRUM BRAKE	2.3 10 V	85	90-95		<b>KA 069</b>
<b>KF 095</b>		1.9 CD-5S; 2.0	85	09.81-09.84	DRUM BRAKE	<b>KA 006</b>
<b>KF 095</b>		2.0 QUATTRO	85	10.83-09.84		
<b>KF 095</b>		2.2	85	10.80-07.83	DISC BRAKE	<b>KA 005</b>
<b>KF 095</b>		2.2	85	10.80-07.83	DRUM BRAKE	<b>KA 006</b>
<b>KF 095</b>		2.2 QUATTRO	96-100	08.82-07.84		
<b>KF 095</b>		1.6 D; 1.6 TD	40-51	08.80-08.86	DISC BRAKE	<b>KA 005</b>
<b>KF 095</b>		1.6 D; 1.6 TD	40-51	08.80-08.86	DRUM BRAKE	<b>KA 006</b>
<b>80 (89,89Q,8A,B3)</b>						
<b>KF 095</b>	CH. --> 89-J-373598	1.4; 1.6	48-55	08.86-09.91	DRUM BRAKE	<b>KA 006</b>
<b>KF 096</b>	CH. 89-J-373599 -->	1.4; 1.6	48-55	08.86-09.91	DISC BRAKE	<b>KA 005</b>
<b>KF 095</b>	CH. --> 89-J-373598	1.4; 1.6	48-55	08.86-09.91	DISC BRAKE	<b>KA 005</b>
<b>KF 096</b>	CH. 89-J-373599 -->	1.4; 1.6	48-55	08.86-09.91	DRUM BRAKE	<b>KA 006</b>
<b>KF 096</b>		1.6	75	08.90-10.91	DISC BRAKE	<b>KA 005</b>
<b>KF 096</b>		1.6	75	08.90-10.91	DRUM BRAKE	<b>KA 006</b>
<b>KF 095</b>	CH. --> 89-J-373598	1.8; 1.8 E; 1.8 S	55-82	06.86-10.91	DISC BRAKE	<b>KA 005</b>
<b>KF 096</b>	CH. 89-J-373599 -->	1.8; 1.8 E; 1.8 S	55-82	06.86-10.91	DRUM BRAKE	<b>KA 006</b>
<b>KF 095</b>	CH. --> 89-J-373598	1.8; 1.8 E; 1.8 S	55-82	06.86-10.91	DRUM BRAKE	<b>KA 006</b>
<b>KF 096</b>	CH. 89-J-373599 -->	1.8; 1.8 E; 1.8 S	55-82	06.86-10.91	DISC BRAKE	<b>KA 005</b>
<b>KF 095</b>	CH. --> 89-J-351000	1.8 E QUATTRO; 1.8 S QUATTRO	65-82	09.86-09.91		
<b>KF 096</b>	CH. 89-J-351001 -->	1.8 E QUATTRO; 1.8 S QUATTRO	65-82	09.86-09.91	CH. 89-J-351001 -->	<b>KF 096</b>
<b>KF 095</b>	CH. --> 89-J-373598	1.8	83	09.86-07.88	DISC BRAKE	<b>KA 005</b>
<b>KF 096</b>	CH. 89-J-373599 -->	1.8	83	09.86-07.88	DRUM BRAKE	<b>KA 006</b>
<b>KF 095</b>	CH. --> 89-J-373598	1.8	83	09.86-07.88	DRUM BRAKE	<b>KA 006</b>
<b>KF 096</b>	CH. 89-J-373599 -->	1.8	83	09.86-07.88	DISC BRAKE	<b>KA 005</b>
<b>KF 095</b>	CH. --> 89-J-351000	1.8 QUATTRO	83	09.86-08.90		
<b>KF 096</b>	CH. 89-J-351001 -->	1.8 QUATTRO	83	09.86-08.90	CH. 89-J-351001 -->	<b>KF 096</b>
<b>KF 096</b>		2.0	82	10.90-08.91	DISC BRAKE	<b>KA 005</b>
<b>KF 096</b>		2.0	82	10.90-08.91	DRUM BRAKE	<b>KA 006</b>
<b>KF 096</b>		2.0 E QUATTRO	82	10.90-08.91		<b>KF 096</b>

 Fersa KIT FRONT	<b>i</b>	ENGINE	POWER (kW)	YEAR	<b>i</b>	Fersa KIT REAR 
<b>AUDI</b>						
<b>80 (89,89Q,8A,B3)</b>						
<b>KF 095</b>	CH. --> 89-J-373598	2.0 E	83	08.88-10.90	DISC BRAKE	<b>KA 005</b>
<b>KF 096</b>	CH. 89-J-373599 -->	2.0 E	83	08.88-10.90	DRUM BRAKE	<b>KA 006</b>
<b>KF 095</b>	CH. --> 89-J-373598	2.0 E	83	08.88-10.90	DRUM BRAKE	<b>KA 006</b>
<b>KF 096</b>	CH. 89-J-373599 -->	2.0 E	83	08.88-10.90	DISC BRAKE	<b>KA 005</b>
<b>KF 095</b>	CH. --> 89-J-351000	2.0 E QUATTRO	83	08.88-09.90		
<b>KF 096</b>	CH. 89-J-351001 -->	2.0 E QUATTRO	83	08.88-09.90	CH. 89-J-351001 -->	<b>KF 096</b>
<b>KF 096</b>		2.0 E 16V QUATTRO; 2.0 QUATTRO	85-101	03.90-08.91		<b>KF 096</b>
<b>KF 096</b>		2.0 E 16V	101	03.90-09.91	DISC BRAKE	<b>KA 005</b>
<b>KF 096</b>		2.0 E 16V	101	03.90-09.91	DRUM BRAKE	<b>KA 006</b>
<b>KF 095</b>	CH. --> 89-J-373598	1.6 D; 1.6 TD	40-59	09.86-08.91	DRUM BRAKE	<b>KA 006</b>
<b>KF 096</b>	CH. 89-J-373599 -->	1.6 D; 1.6 TD	40-59	09.86-08.91	DISC BRAKE	<b>KA 005</b>
<b>KF 095</b>	CH. --> 89-J-373598	1.6 D; 1.6 TD	40-59	09.86-08.91	DISC BRAKE	<b>KA 005</b>
<b>KF 096</b>	CH. 89-J-373599 -->	1.6 D; 1.6 TD	40-59	09.86-08.91	DRUM BRAKE	<b>KA 006</b>
<b>KF 096</b>		1.9 D	50	08.89-08.91	DISC BRAKE	<b>KA 005</b>
<b>KF 096</b>		1.9 D	50	08.89-08.91	DRUM BRAKE	<b>KA 006</b>
<b>80 (8C,B4)</b>						
<b>KF 096</b>		1.6 Limousine; 1.6 E Limousine; 1.6 E Estate Car; 2.0 Limousine; 2.0 Estate Car; 2.0 E Limousine; 2.0 E Estate Car; 2.0 E 16V Limousine; 2.0 E 16V Estate Car	52-103	09.91-01.96	DISC BRAKE	<b>KA 005</b>
<b>KF 096</b>		2.0 E 16V QUATTRO Limousine; 2.0 E QUATTRO Limousine	85-103	09.91-12.94		<b>KF 096</b>
<b>KF 096</b>		2.0 E 16V QUATTRO Estate Car	103	12.92-07.95		<b>KF 098</b>
<b>KF 098</b>		S2 QUATTRO Limousine; S2 QUATTRO Estate Car	169	02.93-07.95		<b>KF 098</b>
<b>KF 098</b>		RS2 (P1) QUATTRO Estate Car	232	03.94-05.95		<b>KF 098</b>
<b>KF 096</b>		2.3 E Limousine; 2.3 E Estate Car	98	09.91-01.96	DISC BRAKE	<b>KA 005</b>
<b>KF 096</b>		2.3 E QUATTRO Limousine	98	09.91-12.94		<b>KF 096</b>
<b>KF 096</b>		2.3 E QUATTRO Estate Car	98	09.91-11.94		<b>KF 098</b>
<b>KF 098</b>		2.6 QUATTRO Limousine	110	06.92-12.94		<b>KF 096</b>
<b>KF 098</b>		2.6 Limousine; 2.6 Estate Car	110	07.92-01.96	DISC BRAKE	<b>KA 005</b>
<b>KF 096</b>		2.6 QUATTRO Estate Car	110	07.92-07.95		<b>KF 098</b>
<b>KF 098</b>		2.8 Limousine; 2.8 Estate Car	128	09.91-01.96	DISC BRAKE	<b>KA 005</b>
<b>KF 098</b>		2.8 QUATTRO Limousine	128	09.91-12.94		<b>KF 096</b>
<b>KF 096</b>		2.8 QUATTRO Estate Car	128	08.92-07.95		<b>KF 098</b>
<b>KF 096</b>		1.9 TD Limousine; 1.9 TD Estate Car; 1.9 TDI Limousine; 1.9 TDI Estate Car	55-66	09.91-01.96	DISC BRAKE	<b>KA 005</b>
<b>KF 096</b>		1.9 TD Limousine; 1.9 TD Estate Car; 1.9 TDI Limousine; 1.9 TDI Estate Car	55-66	09.91-01.96		
		1.9 TD Limousine; 1.9 TD Estate Car; 1.9 TDI Limousine; 1.9 TDI Estate Car	55-66	09.91-01.96	DISC BRAKE	<b>KA 005</b>
<b>90 (81,85,B2)</b>						
<b>KF 096</b>	DRUM BRAKE	1.6,1.8,2.0	83-100	88-91		<b>KA 069</b>
<b>KF 095</b>		2.0; 2.2	83-100	10.84-03.87	DISC BRAKE	<b>KA 005</b>
<b>KF 095</b>		2.0; 2.2	83-100	10.84-03.87	DRUM BRAKE	<b>KA 006</b>
<b>KF 095</b>		2.2 E QUATTRO	88-100	11.84-03.87		
<b>KF 095</b>		2.2	85	01.85-03.87	DISC BRAKE	<b>KA 005</b>
<b>KF 095</b>		2.2	85	01.85-03.87	DRUM BRAKE	<b>KA 006</b>
<b>KF 095</b>		1.6 TD	51	10.85-01.87	DISC BRAKE	<b>KA 005</b>
<b>KF 095</b>		1.6 TD	51	10.85-01.87	DRUM BRAKE	<b>KA 006</b>
<b>90 (89,89Q,8A,B3)</b>						
<b>KF 096</b>		2.0; 2.0 20V	85-118	07.88-09.91	DISC BRAKE	<b>KA 005</b>
<b>KF 096</b>		2.0; 2.0 20V	85-118	07.88-09.91	DRUM BRAKE	<b>KA 006</b>
<b>KF 096</b>		2.0 20V QUATTRO	118	08.88-09.91		<b>KF 096</b>

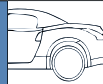

		ENGINE	POWER (kW)	YEAR		
Fersa KIT FRONT						Fersa KIT REAR
<b>AUDI</b>						
<b>90 (89,89Q,8A,B3)</b>						
<b>KF 096</b>	CH. --> 89-J-373599	2.2 E	100	04.87-07.91	DISC BRAKE	<b>KA 005</b>
<b>KF 095</b>	CH. --> 89-J-373599	2.2 E	100	04.87-07.91	DISC BRAKE	<b>KA 005</b>
<b>KF 096</b>	CH. 89-J-373600 -->	2.2 E	100	04.87-07.91	DISC BRAKE	<b>KA 005</b>
<b>KF 096</b>	CH. --> 89-J-373599	2.2 E	100	04.87-07.91	DRUM BRAKE	<b>KA 006</b>
<b>KF 095</b>	CH. --> 89-J-373599	2.2 E	100	04.87-07.91	DRUM BRAKE	<b>KA 006</b>
<b>KF 096</b>	CH. 89-J-373600 -->	2.2 E	100	04.87-07.91	DRUM BRAKE	<b>KA 006</b>
<b>KF 096</b>	CH. --> 89-J-351000	2.2 E QUATTRO	100	04.87-09.91		
<b>KF 095</b>	CH. --> 89-J-351000	2.2 E QUATTRO	100	04.87-09.91		
<b>KF 096</b>	CH. 89-J-351001 -->	2.2 E QUATTRO	100	04.87-09.91	CH. 89-J-351001 -->	<b>KF 096</b>
<b>KF 096</b>		2.3 E QUATTRO	98	04.87-09.91		<b>KF 096</b>
<b>KF 096</b>		2.3 E	98-100	04.87-09.91	DISC BRAKE	<b>KA 005</b>
<b>KF 096</b>	CH. --> 89-J-351000	2.3 E QUATTRO	100	04.87-07.91		
<b>KF 095</b>	CH. --> 89-J-351000	2.3 E QUATTRO	100	04.87-07.91		
<b>KF 096</b>	CH. 89-J-351001 -->	2.3 E QUATTRO	100	04.87-07.91	CH. 89-J-351001 -->	<b>KF 096</b>
<b>KF 098</b>		2.3 E 20V QUATTRO	123-125	06.88-09.91		<b>KF 096</b>
<b>KF 098</b>		2.3 E 20V	123-125	08.88-07.91	DISC BRAKE	<b>KA 005</b>
<b>KF 096</b>	CH. --> 89-J-373598	1.6 TD	59	04.87-09.91	DISC BRAKE	<b>KA 005</b>
<b>KF 095</b>	CH. --> 89-J-373598	1.6 TD	59	04.87-09.91	DISC BRAKE	<b>KA 005</b>
<b>KF 096</b>	CH. 89-J-373599 -->	1.6 TD	59	04.87-09.91	DISC BRAKE	<b>KA 005</b>
<b>KF 096</b>	CH. --> 89-J-373598	1.6 TD	59	04.87-09.91	DRUM BRAKE	<b>KA 006</b>
<b>KF 095</b>	CH. --> 89-J-373598	1.6 TD	59	04.87-09.91	DRUM BRAKE	<b>KA 006</b>
<b>KF 096</b>	CH. 89-J-373599 -->	1.6 TD	59	04.87-09.91	DRUM BRAKE	<b>KA 006</b>
<b>90 SUPER</b>						
		1.8	66	10.66-11.71	DRUM BRAKE	<b>KA 006</b>
<b>100 (43,C2)</b>						
		1.6 Limousine	63	08.76-07.82	--> 12.76	<b>KA 006</b>
		1.6 Limousine	63	08.76-07.82	01.77 -->	<b>KA 005</b>
		1.6 Estate Car; 1.9 Limousine; 1.9 Estate Car	63-74	07.77-02.83		<b>KA 005</b>
		2.0 Limousine	85	06.76-08.78	--> 12.76	<b>KA 006</b>
		2.0 Limousine	85	06.76-08.78	01.77 -->	<b>KA 005</b>
		2.0 Estate Car; 2.1 Limousine; 2.1 Estate Car	85-100	03.77-02.83	DISC BRAKE	<b>KA 005</b>
		2.0 D Limousine; 2.0 D Estate Car	51	08.78-02.83	DISC BRAKE	<b>KA 005</b>
<b>100 (44,44Q,C3)</b>						
		1.8 Limousine; 1.8 Estate Car	55	08.82-12.87	DISC BRAKE	<b>KA 005</b>
<b>KF 098</b>	CH. 44-J-200100 --> / [M.T]	1.8 Limousine	65	02.86-07.88	DISC BRAKE	<b>KA 005</b>
<b>KF 098</b>	CH. 44-J-200100 --> / [M.T]	1.8 Estate Car	65	02.86-07.90	DISC BRAKE	<b>KA 005</b>
<b>KF 098</b>	01.90 --> / [4-A.T]	1.8 Estate Car	65	02.86-07.90	DISC BRAKE	<b>KA 005</b>
<b>KF 098</b>	CH. 44-J-200100 -->	1.8 QUATTRO Limousine; 1.8 QUATTRO Estate Car	65-66	08.85-11.90	CH. 44-J-200100 -->	<b>KF 098</b>
<b>KF 098</b>	CH. 44-J-200100 --> / [M.T]	1.8 Limousine; 1.8 Estate Car	66	08.83-07.89		
		1.8 Limousine; 1.8 Estate Car	66	08.83-07.89	DISC BRAKE	<b>KA 005</b>
<b>KF 098</b>	CH. 44-J-200100 -->	1.8 QUATTRO Limousine	66	10.84-07.88	CH. 44-J-200100 -->	<b>KF 098</b>
<b>KF 098</b>	CH. 44-J-200100 --> / [M.T]	1.8 Limousine; 1.8 Estate Car	66	03.85-11.90		
<b>KF 098</b>	01.90 --> / [4-A.T]	1.8 Limousine; 1.8 Estate Car	66	03.85-11.90	DISC BRAKE	<b>KA 005</b>
		1.9 Limousine; 1.9 Estate Car	74	08.82-07.84	DISC BRAKE	<b>KA 005</b>
		2.0 Limousine; 2.0 Estate Car	83	08.86-11.87	DISC BRAKE	<b>KA 005</b>
		2.0 Limousine; 2.0 E Estate Car	85	08.84-12.87	DISC BRAKE	<b>KA 005</b>
<b>KF 098</b>	[M.T]	2.0 Limousine; 2.0 E Estate Car	85	01.88-11.90	DISC BRAKE	<b>KA 005</b>
<b>KF 098</b>	01.90 --> / [4-A.T]	2.0 Limousine; 2.0 E Estate Car	85	01.88-11.90	DISC BRAKE	<b>KA 005</b>
		2.1 Limousine; 2.1 Estate Car; 2.2 Limousine	79-100	08.82-07.84	DISC BRAKE	<b>KA 005</b>
		2.2 Limousine; 2.2 Estate Car	85	10.84-09.86	DISC BRAKE	<b>KA 005</b>

 Fersa KIT FRONT	<b>i</b>	ENGINE	POWER (kW)	YEAR	<b>i</b>	Fersa KIT REAR 
<b>AUDI</b>						
<b>100 (44,44Q,C3)</b>						
<b>KF 098</b>	CH. 44-J-200100 --> / [M.T]	2.2 Limousine	101	08.84-12.88	DISC BRAKE	<b>KA 005</b>
<b>KF 098</b>	CH. 44-J-200100 --> / [M.T]	2.2 Estate Car	101	08.84-12.88	DISC BRAKE	<b>KA 005</b>
<b>KF 098</b>	CH. 44-J-200100 -->	2.2 QUATTRO Limousine	101	08.84-12.88	CH. 44-J-200100 -->	<b>KF 098</b>
<b>KF 098</b>	CH. 44-J-200100 -->	2.2 QUATTRO Estate Car	101	08.84-12.88	CH. 44-J-200100 -->	<b>KF 098</b>
<b>KF 098</b>	[M.T]	2.2 Limousine	101	06.89-11.90		
<b>KF 098</b>	01.90 --> / [4-A.T]	2.2 Limousine	101	06.89-11.90	DISC BRAKE	<b>KA 005</b>
<b>KF 098</b>	[M.T]	2.2 Estate Car	101	06.89-11.90		
<b>KF 098</b>	01.90 --> / [4-A.T]	2.2 Estate Car	101	06.89-11.90	DISC BRAKE	<b>KA 005</b>
<b>KF 098</b>		2.2 QUATTRO Limousine	101	06.89-11.90		<b>KF 098</b>
<b>KF 098</b>		2.2 QUATTRO Estate Car	101	06.89-11.90		<b>KF 098</b>
<b>KF 098</b>	CH. 44-J-200100 --> / [M.T]	2.2 TURBO Limousine; 2.2 TURBO Estate Car	121	08.86-11.90	DISC BRAKE	<b>KA 005</b>
<b>KF 098</b>	01.90 --> / [4-A.T]	2.2 TURBO Limousine; 2.2 TURBO Estate Car	121	08.86-11.90	DISC BRAKE	<b>KA 005</b>
<b>KF 098</b>	CH. 44-J-200100 -->	2.2 E TURBO QUATTRO Limousine; 2.2 TURBO QUATTRO Estate Car	121	08.86-11.90	CH. 44-J-200100 -->	<b>KF 098</b>
<b>KF 098</b>	[4-A.T]	2.3 Estate Car; 2.3 E Limousine	98	01.90-11.90		
<b>KF 098</b>	[M.T]	2.3 Estate Car; 2.3 E Limousine	98	01.90-11.90		
		2.3 Estate Car; 2.3 E Limousine	98	01.90-11.90	DISC BRAKE	<b>KA 005</b>
<b>KF 098</b>		2.3 QUATTRO Limousine; 2.3 QUATTRO Estate Car	98	01.90-11.90		<b>KF 098</b>
<b>KF 098</b>	CH. 44-J-200100 --> / [M.T]	2.3 Estate Car; 2.3 E Limousine	100	08.86-11.90	DISC BRAKE	<b>KA 005</b>
<b>KF 098</b>	01.90 --> / [4-A.T]	2.3 Estate Car; 2.3 E Limousine	100	08.86-11.90	DISC BRAKE	<b>KA 005</b>
<b>KF 098</b>	CH. 44-J-200100 -->	2.3 E QUATTRO Limousine; 2.3 E QUATTRO Estate Car	100	08.86-11.90	CH. 44-J-200100 -->	<b>KF 098</b>
<b>KF 098</b>	CH. 44-J-200100 --> / [M.T]	2.0 D Limousine	51	08.82-07.88	DISC BRAKE	<b>KA 005</b>
<b>KF 098</b>	CH. 44-J-200100 --> / [M.T]	2.0 D Estate Car	51	03.83-11.90	DISC BRAKE	<b>KA 005</b>
<b>KF 098</b>	01.90 --> / [4-A.T]	2.0 D Estate Car	51	03.83-11.90	DISC BRAKE	<b>KA 005</b>
<b>KF 098</b>	CH. 44-J-200100 --> / [M.T]	2.0 D TURBO Limousine	64	08.82-02.88	DISC BRAKE	<b>KA 005</b>
		2.0 TD Estate Car	64	03.83-10.87	DISC BRAKE	<b>KA 005</b>
<b>KF 098</b>	[M.T]	2.0 D TURBO Limousine; 2.0 TD Estate Car; 2.4 D Limousine; 2.4 D Estate Car	60-74	03.88-07.91	DISC BRAKE	<b>KA 005</b>
<b>KF 098</b>	01.90 --> / [4-A.T]	2.0 D TURBO Limousine; 2.0 TD Estate Car; 2.4 D Limousine; 2.4 D Estate Car	60-74	03.88-07.91	DISC BRAKE	<b>KA 005</b>
<b>KF 098</b>	[4-A.T]	2.5 TDI Limousine; 2.5 TDI Estate Car	88	01.90-11.90	DISC BRAKE	<b>KA 005</b>
<b>KF 098</b>	[M.T]	2.5 TDI Limousine; 2.5 TDI Estate Car	88	01.90-11.90	DISC BRAKE	<b>KA 005</b>
<b>100 (4A,C4)</b>						
<b>KF 098</b>		2.0 Limousine; 2.0 E Limousine; 2.0 E Estate Car; 2.0 E 16V Limousine	74-103	12.90-06.94	DISC BRAKE	<b>KA 005</b>
<b>KF 098</b>		2.0 E QUATTRO Limousine; 2.0 E QUATTRO Estate Car;	85-169	12.90-06.94		<b>KF 098</b>
<b>KF 098</b>		2.3 E Limousine; 2.3 E Estate Car	98	12.90-06.94	DISC BRAKE	<b>KA 005</b>
<b>KF 098</b>		2.3 E QUATTRO Limousine; 2.3 E QUATTRO Estate Car	98	12.90-06.94		<b>KF 098</b>
<b>KF 098</b>		2.6 Limousine; 2.6 Estate Car	102-110	03.92-06.94	DISC BRAKE	<b>KA 005</b>
<b>KF 098</b>		2.6 QUATTRO Limousine; 2.6 QUATTRO Estate Car	110	04.92-06.94		<b>KF 098</b>
<b>KF 098</b>		2.8 E Limousine; 2.8 E Estate Car	128	12.90-06.94	DISC BRAKE	<b>KA 005</b>
<b>KF 098</b>		2.8 E QUATTRO Estate Car; S4 V8 QUATTRO Limousine;	128-213	09.91-06.94		<b>KF 098</b>
<b>KF 098</b>		2.4 D Limousine; 2.4 D Estate Car; 2.5 TDI Limousine; 2.5 TDI Estate Car	60-85	12.90-06.94	DISC BRAKE	<b>KA 005</b>
<b>100 (C1)</b>						
		1.6 Limousine	63	01.75-07.76	DRUM BRAKE	<b>KA 006</b>
		1.8 Limousine	59-66	11.68-07.74	DRUM BRAKE	<b>KA 006</b>
		1.8 LS Limousine; 1.9 Coupé; 1.9 GL Limousine	74-82	01.70-12.76	DRUM BRAKE	<b>KA 006</b>
		1.9 Coupé	85	07.70-07.71	DRUM BRAKE	<b>KA 006</b>
<b>200 (43)</b>						
		2.1 5 E; 2.1 5 T	100-125	10.79-09.82	DISC BRAKE	<b>KA 005</b>

	<b>i</b>	<b>ENGINE</b>	<b>POWER (kW)</b>	<b>YEAR</b>	<b>i</b>	
Fersa KIT FRONT						Fersa KIT REAR
<b>AUDI</b>						
<b>200 (44,44Q)</b>						
		2.1 5 E Limousine	100	08.83-07.84	DISC BRAKE	<b>KA 005</b>
		2.1 TURBO Limousine	134	08.83-01.88	DISC BRAKE	<b>KA 005</b>
		2.2 Limousine	101	08.84-07.85	DISC BRAKE	<b>KA 005</b>
<b>KF 098</b>	01.88 --> / CH. 44-J-200100 -->	2.2 TURBO QUATTRO Estate Car	121	09.83-12.90	01.88 --> / CH. 44-J-200100 -->	<b>KF 098</b>
<b>KF 098</b>	01.88 --> / CH. 44-J-200100 -->	2.2 TURBO QUATTRO Limousine	121	01.85-12.91	01.88 --> / CH. 44-J-200100 -->	<b>KF 098</b>
<b>KF 098</b>	CH. 44-J-200100 --> / [M.T]	2.2 TURBO Limousine; 2.2 TURBO Estate Car	121	08.85-09.91	DISC BRAKE	<b>KA 005</b>
<b>KF 098</b>	CH. 44-J-200100 --> / [M.T]	2.2 TURBO Limousine	140-147	02.88-12.90	DISC BRAKE	<b>KA 005</b>
<b>KF 098</b>		2.2 20V QUATTRO Limousine; 2.2 20V QUATTRO Estate Car; 2.2 TURBO QUATTRO Limousine; 2.2 TURBO QUATTRO Estate Car	147-162	02.88-12.91		<b>KF 098</b>
<b>KF 098</b>	02.88 --> / CH. 44-J-200100 --> / [M.T]	2.3 Limousine; 2.3 Estate Car	100	11.86-09.91	DISC BRAKE	<b>KA 005</b>
<b>A2 (8Z0)</b>						
<b>KV 287</b>		1.4; 1.6 FSI	55-81	02.00-08.05		<b>KV 286</b>
<b>KV 285</b>		1.2 TDI	45	03.01-08.05		
<b>KV 287</b>		1.4 TDI	55-66	02.00-08.05		<b>KV 286</b>
<b>A3 (8L1)</b>						
<b>KF 184</b>		1.6; 1.8; 1.8 QUATTRO; 1.8 T; 1.8 T QUATTRO; S3 QUATTRO	74-165	09.96-		<b>KV 194</b>
<b>KF 184</b>		1.9 TDI; 1.9 TDI QUATTRO	66-96	09.96-		<b>KV 194</b>
<b>A4 (8D2,8D5,8D5)</b>						
<b>KF 096</b>		1.6 Limousine; 1.6 Estate Car	74	01.95-07.00	CH. --> 8D-V-152676	<b>KA 005</b>
<b>KF 096</b>		1.6 Limousine; 1.6 Estate Car	74	01.95-07.00	CH. 8D-V-152677 -->	<b>KA 248</b>
<b>KF 096</b>		1.6 Limousine; 1.6 Estate Car	75	07.00-09.01		<b>KA 248</b>
<b>KF 096</b>		1.8 Limousine; 1.8 Estate Car; 1.8 T Limousine; 1.8 T Estate Car	85-110	01.95-09.01	CH. --> 8D-V-152676	<b>KA 005</b>
<b>KF 096</b>		1.8 Limousine; 1.8 Estate Car; 1.8 T Limousine; 1.8 T Estate Car	85-110	01.95-09.01	CH. 8D-V-152677 -->	<b>KA 248</b>
<b>KF 096</b>		1.8 QUATTRO Limousine; 1.8 QUATTRO Estate Car; 1.8 T QUATTRO Limousine; 1.8 T QUATTRO Estate Car	85-110	01.95-09.01		<b>KF 096</b>
<b>KF 098</b>		1.8 T Limousine; 1.8 T Estate Car	132	12.97-09.01	CH. --> 8D-V-152676	<b>KA 005</b>
<b>KF 098</b>		1.8 T Limousine; 1.8 T Estate Car	132	12.97-09.01	CH. 8D-V-152677 -->	<b>KA 248</b>
<b>KF 098</b>		1.8 T QUATTRO Limousine; 1.8 T QUATTRO Estate Car	132	12.97-09.01		<b>KF 096</b>
<b>KF 098</b>		2.4 Limousine; 2.4 Estate Car	120-121	03.97-09.01	CH. --> 8D-V-152676	<b>KA 005</b>
<b>KF 098</b>		2.4 Limousine; 2.4 Estate Car	120-121	03.97-09.01	CH. 8D-V-152677 -->	<b>KA 248</b>
<b>KF 098</b>		2.4 QUATTRO Limousine; 2.4 QUATTRO Estate Car	120-121	03.97-09.01		<b>KF 096</b>
<b>KF 308</b>	CH. --> 8D-T-160955	2.6 Limousine	110	01.95-11.00		
<b>KF 098</b>	CH. 8D-T-160956 -->	2.6 Limousine	110	01.95-11.00		
		2.6 Limousine	110	01.95-11.00	CH. --> 8D-V-152676	<b>KA 005</b>
		2.6 Limousine	110	01.95-11.00	CH. 8D-V-152677 -->	<b>KA 248</b>
<b>KF 308</b>	CH. --> 8D-T-160955	2.6 QUATTRO Limousine; 2.6 QUATTRO Estate Car	110	01.95-09.01		<b>KF 096</b>
<b>KF 098</b>		2.6 Estate Car	110	02.96-09.01	CH. --> 8D-V-152676	<b>KA 005</b>
<b>KF 098</b>		2.6 Estate Car	110	02.96-09.01	CH. 8D-V-152677 -->	<b>KA 248</b>
		S4 QUATTRO Limousine; S4 QUATTRO Estate Car	195	09.97-09.01		<b>KF 096</b>
<b>KV 250</b>		RS4 QUATTRO Estate Car	280	05.00-09.01		<b>KF 096</b>
<b>KV 250</b>		RS4 QUATTRO Estate Car	280	05.00-09.01		
<b>KF 308</b>	CH. --> 8D-T-160955	2.8 Limousine; 2.8 Estate Car	128	09.95-07.97		
<b>KF 098</b>	CH. 8D-T-160956 -->	2.8 Limousine; 2.8 Estate Car	128	09.95-07.97		
		2.8 Limousine; 2.8 Estate Car	128	09.95-07.97	CH. --> 8D-V-152676	<b>KA 005</b>
		2.8 Limousine; 2.8 Estate Car	128	09.95-07.97	CH. 8D-V-152677 -->	<b>KA 248</b>
<b>KF 308</b>		2.8 QUATTRO Limousine; 2.8 QUATTRO Estate Car	128-142	01.95-11.00		<b>KF 096</b>
<b>KF 098</b>		2.8 Limousine; 2.8 Estate Car	142	10.96-09.01	CH. --> 8D-V-152676	<b>KA 005</b>
<b>KF 098</b>		2.8 Limousine; 2.8 Estate Car	142	10.96-09.01	CH. 8D-V-152677 -->	<b>KA 248</b>
		2.8 QUATTRO Estate Car	142	10.96-09.01		<b>KF 096</b>
<b>KF 096</b>		1.9 TDI Limousine; 1.9 TDI Estate Car	55	12.95-09.01	CH. --> 8D-V-152676	<b>KA 005</b>
<b>KF 096</b>		1.9 TDI Limousine; 1.9 TDI Estate Car	55	12.95-09.01	CH. 8D-V-152677 -->	<b>KA 248</b>

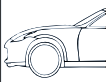
 Fersa KIT FRONT	<b>i</b>	ENGINE	POWER (kW)	YEAR	<b>i</b>	Fersa KIT REAR
<b>AUDI</b>						
<b>A4 (8D2,8D5,B5)</b>						
<b>KF 096</b>		1.9 DUO Estate Car	66	03.98-09.01		<b>KA 248</b>
<b>KF 096</b>		1.9 TDI Limousine; 1.9 TDI Estate Car	66-81	01.95-09.01	CH. --> 8D-V-152676	<b>KA 005</b>
		1.9 TDI Limousine; 1.9 TDI Estate Car	66-81	01.95-09.01	CH. 8D-V-152677 -->	<b>KA 248</b>
<b>KF 096</b>		1.9 TDI QUATTRO Limousine; 1.9 TDI QUATTRO Estate Car	81	09.96-09.01		<b>KF 096</b>
<b>KF 096</b>		1.9 TDI Limousine; 1.9 TDI Estate Car	85	03.00-09.01		<b>KA 248</b>
		1.9 TDI QUATTRO Limousine; 1.9 TDI QUATTRO Estate Car	85	03.00-09.01		<b>KF 096</b>
<b>KF 098</b>		2.5 TDI Limousine; 2.5 TDI Estate Car	110	09.97-09.01	CH. --> 8D-V-152676	<b>KA 005</b>
<b>KF 098</b>		2.5 TDI Limousine; 2.5 TDI Estate Car	110	09.97-09.01	CH. 8D-V-152677 -->	<b>KA 248</b>
<b>KF 098</b>		2.5 TDI QUATTRO Limousine; 2.5 TDI QUATTRO Estate Car	110	09.97-09.01		<b>KF 096</b>
<b>A4 (8E2,8E5,B6)</b>						
<b>KV 250</b>		1.6 Limousine; 1.6 Estate Car; 1.8 T Limousine; 1.8 T Estate Car	75-140	11.00-12.04		
<b>KV 250</b>		1.8 T QUATTRO Limousine; 1.8 T QUATTRO Estate Car	110-140	11.00-12.04		
<b>KV 250</b>		2.0 Limousine; 2.0 Estate Car; 2.0 FSI Limousine; 2.0 FSI Estate Car; 2.4 Limousine; 2.4 Estate Car; 3.0 Limousine; 3.0 Estate Car	96-162	11.00-12.04		
<b>KV 250</b>		3.0 quattro Limousine; 3.0 quattro Estate Car; 3.0 QUATTRO Limousine; 3.0 QUATTRO Estate Car; S4 QUATTRO Limousine; S4 QUATTRO Estate Car	160-253	11.00-12.04		
<b>KV 250</b>		1.9 TDI Limousine; 1.9 TDI Estate Car	74-96	11.00-12.04		
<b>KV 250</b>		1.9 TDI QUATTRO Limousine; 1.9 TDI QUATTRO Estate Car	96	11.01-12.04		
<b>KV 250</b>		2.5 TDI Limousine; 2.5 TDI Estate Car	114-120	08.01-12.04		
<b>KV 250</b>		2.5 TDI QUATTRO Limousine; 2.5 TDI QUATTRO Estate Car	132	11.00-12.04		
<b>A4 (8EC,8ED)</b>						
<b>KV 250</b>		1.6; 1.8 T	75-120	11.04-		
<b>KV 250</b>		1.8 T quattro	120	11.04-		
<b>KV 250</b>		2.0; 2.0 FSI; 2.0 TFSI	96-162	11.04-		
<b>KV 250</b>		2.0 TFSI quattro	147-162	11.04-		
<b>KV 250</b>		3.0 quattro	160	11.04-07.06		
<b>KV 250</b>		3.0	160	03.05-		
<b>KV 250</b>		3.2 FSI	188	01.05-		
<b>KV 250</b>		3.2 FSI quattro; S4 quattro	188-253	11.04-		
<b>KV 250</b>		RS4 quattro	309	09.05-		
<b>KV 250</b>		1.9 TDI; 2.0 TDI	85-125	11.04-		
<b>KV 250</b>		2.0 TDI quattro	103-125	01.06-		
<b>KV 250</b>		2.5 TDI; 2.7 TDI	120-132	11.04-		
<b>KV 250</b>		3.0 TDI quattro	150-171	11.04-		
<b>A4 CABRIOLET</b>						
<b>KV 250</b>		1.8 T	120	07.02-		
<b>KV 250</b>		1.8 T QUATTRO	120	05.03-		
<b>KV 250</b>		2.0; 2.0 TFSI; 2.4; 3.0	96-162	04.02-		
<b>KV 250</b>		3.0 QUATTRO	162	05.03-		
<b>KV 250</b>		3.2 FSI	188	10.05-		
<b>KV 250</b>		3.2 FSI quattro; S4 QUATTRO	188-253	03.04-		
<b>KV 250</b>		RS4 quattro	309	06.06-		
<b>KV 250</b>		2.0 TDI; 2.5 TDI; 2.7 TDI	103-132	08.02-		
<b>KV 250</b>		3.0 TDI quattro	150-171	10.05-		
<b>A6 (4A,C4)</b>						
<b>KF 098</b>		1.8	92	12.95-12.97	DISC BRAKE	<b>KA 005</b>
<b>KF 098</b>		1.8 QUATTRO	92	12.95-12.97		<b>KF 307</b>
<b>KF 098</b>		2.0; 2.0 16V	74-103	06.94-12.97	DISC BRAKE	<b>KA 005</b>
<b>KF 098</b>		2.0 16V QUATTRO; S6 TURBO QUATTRO	103-169	06.94-12.97		<b>KF 307</b>
<b>KF 098</b>		2.3	98	06.94-12.95	DISC BRAKE	<b>KA 005</b>

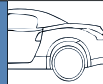
	<b>i</b>	<b>ENGINE</b>	<b>POWER (kW)</b>	<b>YEAR</b>	<b>i</b>	
Fersa KIT FRONT						Fersa KIT REAR
<b>AUDI</b>						
<b>A8 (4D2,4D8)</b>						
<b>KF 098</b>		2.3 QUATTRO	98	06.94-12.95		<b>KF 307</b>
<b>KF 098</b>		2.6	110	06.94-12.97	DISC BRAKE	<b>KA 005</b>
<b>KF 098</b>		2.6 QUATTRO	110	06.94-12.97		<b>KF 307</b>
<b>KF 098</b>		2.8	128-142	06.94-12.97	DISC BRAKE	<b>KA 005</b>
<b>KF 098</b>		2.8 QUATTRO; S6 4.2 QUATTRO; S6 PLUS QUATTRO	128-240	06.94-12.97		<b>KF 307</b>
<b>KF 098</b>		1.9 TDI; 2.5 TDI	66-103	06.94-12.97	DISC BRAKE	<b>KA 005</b>
<b>KF 098</b>		2.5 TDI QUATTRO	103	07.95-12.97		<b>KF 307</b>
<b>A6 (4B,C5)</b>						
<b>KF 096</b>	--> 08.01	1.8 Limousine; 1.8 Estate Car	85-92	05.97-01.05		<b>KV 276</b>
<b>KV 250</b>	CH. 4B-2-031501 -->	1.8 Limousine; 1.8 Estate Car	85-92	05.97-01.05		<b>KV 276</b>
<b>KV 250</b>	09.01 --> / CH. --> 4B-2-031500	1.8 Limousine; 1.8 Estate Car	85-92	05.97-01.05		<b>KV 276</b>
<b>KF 096</b>	08.01 / [M.T]	1.8 T Limousine; 1.8 T Estate Car	110	01.97-01.05		<b>KV 276</b>
<b>KV 250</b>	CH. 4B-2-031501 -->	1.8 T Limousine; 1.8 T Estate Car	110	01.97-01.05		<b>KV 276</b>
<b>KV 250</b>	09.01 --> / CH. --> 4B-2-031500	1.8 T Limousine; 1.8 T Estate Car	110	01.97-01.05		<b>KV 276</b>
<b>KF 096</b>	08.01 / [M.T]	1.8 T QUATTRO Limousine	110	02.97-01.05	--> 08.01	<b>KF 098</b>
<b>KV 250</b>	CH. 4B-2-031501 -->	1.8 T QUATTRO Limousine	110	02.97-01.05		<b>KF 307</b>
<b>KV 250</b>	09.01 --> / CH. --> 4B-2-031500	1.8 T QUATTRO Limousine	110	02.97-01.05		<b>KF 307</b>
<b>KF 096</b>	08.01 / [M.T]	1.8 T QUATTRO Estate Car	110	12.97-01.05		<b>KF 307</b>
<b>KV 250</b>	CH. 4B-2-031501 -->	1.8 T QUATTRO Estate Car	110	12.97-01.05		<b>KF 307</b>
<b>KV 250</b>	09.01 --> / CH. --> 4B-2-031500	1.8 T QUATTRO Estate Car	110	12.97-01.05		<b>KF 307</b>
<b>KV 250</b>	CH. 4B-2-031501 -->	1.8 T Limousine; 1.8 T Estate Car	132	12.97-01.05		<b>KV 276</b>
<b>KV 250</b>	09.01 --> / CH. --> 4B-2-031500	1.8 T Limousine; 1.8 T Estate Car	132	12.97-01.05		<b>KV 276</b>
<b>KV 250</b>	CH. 4B-2-031501 -->	1.8 T QUATTRO Limousine	132	12.97-01.05		<b>KF 307</b>
<b>KV 250</b>	09.01 --> / CH. --> 4B-2-031500	1.8 T QUATTRO Limousine	132	12.97-01.05	--> 08.01	<b>KF 098</b>
<b>KV 250</b>	CH. 4B-2-031501 -->	1.8 T QUATTRO Estate Car	132	12.97-01.05		<b>KF 307</b>
<b>KV 250</b>	09.01 --> / CH. --> 4B-2-031500	1.8 T QUATTRO Estate Car	132	12.97-01.05		<b>KF 307</b>
<b>KV 250</b>	CH. --> 4B-2-031500	2.0 Limousine; 2.0 Estate Car	96	08.01-01.05		<b>KV 276</b>
<b>KV 250</b>	CH. 4B-2-031501 -->	2.0 Limousine; 2.0 Estate Car	96	08.01-01.05		<b>KV 276</b>
<b>KV 250</b>	CH. 4B-2-031501 -->	2.4 Limousine; 2.4 Estate Car	100-121	02.97-01.05		<b>KV 276</b>
<b>KV 250</b>	09.01 --> / CH. --> 4B-2-031500	2.4 Limousine; 2.4 Estate Car	100-121	02.97-01.05		<b>KV 276</b>
<b>KV 250</b>	09.01 -->	2.4 Limousine; 2.4 Estate Car	100-121	02.97-01.05		<b>KV 276</b>
		2.4 QUATTRO Limousine	115	08.98-07.99		<b>KF 098</b>
		2.4 QUATTRO Estate Car	115	08.98-05.01		<b>KF 307</b>
<b>KV 250</b>	CH. 4B-2-031501 -->	2.4 QUATTRO Limousine	120	02.97-01.05		<b>KF 307</b>
<b>KV 250</b>	09.01 --> / CH. --> 4B-2-031500	2.4 QUATTRO Limousine	120	02.97-01.05		<b>KF 307</b>
<b>KV 250</b>	09.01 -->	2.4 QUATTRO Limousine	120	02.97-01.05		<b>KF 307</b>
		2.4 QUATTRO Limousine	120	02.97-01.05	--> 08.01	<b>KF 098</b>
<b>KV 250</b>	09.01 --> / CH. --> 4B-2-031500	2.4 QUATTRO Limousine	120	02.97-01.05	09.01 -->	<b>KV 250</b>
<b>KV 250</b>	09.01 -->	2.4 QUATTRO Limousine	120	02.97-01.05	09.01 -->	<b>KV 250</b>
<b>KV 250</b>	CH. 4B-2-031501 -->	2.4 QUATTRO Estate Car	120	12.97-01.05		<b>KF 307</b>
<b>KV 250</b>	09.01 --> / CH. --> 4B-2-031500	2.4 QUATTRO Estate Car	120	12.97-01.05		<b>KF 307</b>
<b>KV 250</b>	09.01 -->	2.4 QUATTRO Estate Car	120	12.97-01.05		<b>KF 307</b>
<b>KV 250</b>	09.01 --> / CH. --> 4B-2-031500	2.4 QUATTRO Estate Car	120	12.97-01.05	09.01 -->	<b>KV 250</b>
<b>KV 250</b>	09.01 -->	2.4 QUATTRO Estate Car	120	12.97-01.05	09.01 -->	<b>KV 250</b>
<b>KV 250</b>	CH. 4B-2-031501 -->	2.4 QUATTRO Limousine	121	02.97-01.05		<b>KF 307</b>
<b>KV 250</b>	09.01 --> / CH. --> 4B-2-031500	2.4 QUATTRO Limousine	121	02.97-01.05		<b>KF 307</b>
<b>KV 250</b>	09.01 -->	2.4 QUATTRO Limousine	121	02.97-01.05		<b>KF 307</b>
		2.4 QUATTRO Limousine	121	02.97-01.05	--> 08.01	<b>KF 098</b>
<b>KV 250</b>	09.01 --> / CH. --> 4B-2-031500	2.4 QUATTRO Limousine	121	02.97-01.05	09.01 -->	<b>KV 250</b>
<b>KV 250</b>	09.01 -->	2.4 QUATTRO Limousine	121	02.97-01.05	09.01 -->	<b>KV 250</b>
<b>KV 250</b>	CH. 4B-2-031501 -->	2.4 QUATTRO Estate Car	121	12.97-01.05		<b>KF 307</b>
<b>KV 250</b>	09.01 --> / CH. --> 4B-2-031500	2.4 QUATTRO Estate Car	121	12.97-01.05		<b>KF 307</b>
<b>KV 250</b>	09.01	2.4 QUATTRO Estate Car	121	12.97-01.05		<b>KF 307</b>

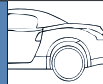

	<b>i</b>	<b>ENGINE</b>	<b>POWER (kW)</b>	<b>YEAR</b>	<b>i</b>	
Fersa KIT FRONT						Fersa KIT REAR
<b>AUDI</b>						
<b>A6 (4B,C5)</b>						
<b>KV 250</b>	09.01 --> / CH. --> 4B-2-031500	2.4 QUATTRO Estate Car	121	12.97-01.05	09.01 -->	<b>KV 250</b>
<b>KV 250</b>	09.01 -->	2.4 QUATTRO Estate Car	121	12.97-01.05	09.01 -->	<b>KV 250</b>
<b>KV 250</b>	CH--> 4B-2-031500	2.4 Limousine; 2.4 Estate Car	125	08.01-01.05		<b>KV 276</b>
<b>KV 250</b>	CH. 4B-2-031501 -->	2.4 Limousine; 2.4 Estate Car	125	08.01-01.05		<b>KV 276</b>
<b>KV 250</b>	CH--> 4B-2-031500	2.4 QUATTRO Limousine; 2.4 QUATTRO Estate Car	125	08.01-01.05		<b>KF 307</b>
<b>KV 250</b>	CH. 4B-2-031501 -->	2.4 QUATTRO Limousine; 2.4 QUATTRO Estate Car	125	08.01-01.05		<b>KF 307</b>
<b>KV 250</b>		2.4 QUATTRO Limousine; 2.4 QUATTRO Estate Car	125	08.01-01.05		<b>KF 307</b>
<b>KV 250</b>		2.4 QUATTRO Limousine; 2.4 QUATTRO Estate Car	125	08.01-01.05		<b>KV 250</b>
<b>KV 250</b>	CH--> 4B-2-031500	2.4 QUATTRO Limousine; 2.4 QUATTRO Estate Car	125	08.01-01.05		<b>KV 250</b>
<b>KV 250</b>	CH. 4B-2-031501 -->	2.4 QUATTRO Limousine; 2.4 QUATTRO Estate Car	125	08.01-01.05		<b>KV 250</b>
<b>KV 250</b>	CH. 4B-2-031501 -->	2.7 T QUATTRO Limousine	169	12.97-01.05		<b>KF 307</b>
<b>KV 250</b>	09.01 --> / CH. --> 4B-2-031500	2.7 T QUATTRO Limousine	169	12.97-01.05		<b>KF 307</b>
<b>KV 250</b>	09.01 -->	2.7 T QUATTRO Limousine	169	12.97-01.05		<b>KF 307</b>
		2.7 T QUATTRO Limousine	169	12.97-01.05	--> 08.01	<b>KF 098</b>
<b>KV 250</b>	09.01 --> / CH. --> 4B-2-031500	2.7 T QUATTRO Limousine	169	12.97-01.05	09.01 -->	<b>KV 250</b>
<b>KV 250</b>	09.01 -->	2.7 T QUATTRO Limousine	169	12.97-01.05	09.01 -->	<b>KV 250</b>
<b>KV 250</b>	CH. 4B-2-031501 -->	2.7 T QUATTRO Estate Car	169	12.97-01.05		<b>KF 307</b>
<b>KV 250</b>	09.01 --> / CH. --> 4B-2-031500	2.7 T QUATTRO Estate Car	169	12.97-01.05		<b>KF 307</b>
<b>KV 250</b>	09.01 -->	2.7 T QUATTRO Estate Car	169	12.97-01.05		<b>KF 307</b>
<b>KV 250</b>	09.01 --> / CH. --> 4B-2-031500	2.7 T QUATTRO Estate Car	169	12.97-01.05	09.01 -->	<b>KV 250</b>
<b>KV 250</b>	09.01 -->	2.7 T QUATTRO Estate Car	169	12.97-01.05	09.01 -->	<b>KV 250</b>
<b>KV 250</b>	CH. 4B-2-031501 -->	2.7 T Limousine; 2.7 T Estate Car	169	02.99-01.05		
<b>KV 250</b>	09.01 --> / CH. --> 4B-2-031500	2.7 T Limousine; 2.7 T Estate Car	169	02.99-01.05		
<b>KV 250</b>	09.01 -->	2.7 T Limousine; 2.7 T Estate Car	169	02.99-01.05		
		2.7 T Limousine; 2.7 T Estate Car	169	02.99-01.05		<b>KV 276</b>
<b>KV 250</b>	CH--> 4B-2-031500	2.7 T QUATTRO Limousine; 2.7 T QUATTRO Estate Car	184	08.01-01.05		<b>KF 307</b>
<b>KV 250</b>	CH. 4B-2-031501 -->	2.7 T QUATTRO Limousine; 2.7 T QUATTRO Estate Car	184	08.01-01.05		<b>KF 307</b>
<b>KV 250</b>		2.7 T QUATTRO Limousine; 2.7 T QUATTRO Estate Car	184	08.01-01.05		<b>KF 307</b>
<b>KV 250</b>	CH--> 4B-2-031500	2.7 T QUATTRO Limousine; 2.7 T QUATTRO Estate Car	184	08.01-01.05		<b>KV 250</b>
<b>KV 250</b>	CH. 4B-2-031501 -->	2.7 T QUATTRO Limousine; 2.7 T QUATTRO Estate Car	184	08.01-01.05		<b>KV 250</b>
<b>KV 250</b>		2.7 T QUATTRO Limousine; 2.7 T QUATTRO Estate Car	184	08.01-01.05		<b>KV 250</b>
		2.8 Limousine; 2.8 Estate Car	132	10.97-07.98		<b>KV 276</b>
<b>KV 250</b>	CH. 4B-2-031501 -->	2.8 Limousine; 2.8 Estate Car	140-142	02.97-01.05		<b>KV 276</b>
<b>KV 250</b>	09.01 --> / CH. --> 4B-2-031500	2.8 Limousine; 2.8 Estate Car	140-142	02.97-01.05		<b>KV 276</b>
<b>KV 250</b>	09.01 -->	2.8 Limousine; 2.8 Estate Car	140-142	02.97-01.05		<b>KV 276</b>
<b>KV 250</b>	CH. 4B-2-031501 -->	2.8 QUATTRO Limousine	142	02.97-01.05		<b>KF 307</b>
<b>KV 250</b>	09.01 --> / CH. --> 4B-2-031500	2.8 QUATTRO Limousine	142	02.97-01.05		<b>KF 307</b>
<b>KV 250</b>	09.01 -->	2.8 QUATTRO Limousine	142	02.97-01.05		<b>KF 307</b>
		2.8 QUATTRO Limousine	142	02.97-01.05	--> 08.01	<b>KF 098</b>
<b>KV 250</b>	09.01 --> / CH. --> 4B-2-031500	2.8 QUATTRO Limousine	142	02.97-01.05	09.01 -->	<b>KV 250</b>
<b>KV 250</b>	09.01 -->	2.8 QUATTRO Limousine	142	02.97-01.05	09.01 -->	<b>KV 250</b>
<b>KV 250</b>	CH. 4B-2-031501 -->	2.8 QUATTRO Estate Car	142	12.97-01.05		<b>KF 307</b>
<b>KV 250</b>	09.01 --> / CH. --> 4B-2-031500	2.8 QUATTRO Estate Car	142	12.97-01.05		<b>KF 307</b>
<b>KV 250</b>	09.01 -->	2.8 QUATTRO Estate Car	142	12.97-01.05		<b>KF 307</b>
<b>KV 250</b>	09.01 --> / CH. --> 4B-2-031500	2.8 QUATTRO Estate Car	142	12.97-01.05	09.01 -->	<b>KV 250</b>
<b>KV 250</b>	09.01 -->	2.8 QUATTRO Estate Car	142	12.97-01.05	09.01 -->	<b>KV 250</b>
<b>KV 250</b>	--> 4B-2-031500	3.0 Limousine; 3.0 Estate Car	162	08.01-01.05		<b>KV 276</b>
<b>KV 250</b>	CH. 4B-2-031501 -->	3.0 Limousine; 3.0 Estate Car	162	08.01-01.05		<b>KV 276</b>
<b>KV 250</b>		3.0 Limousine; 3.0 Estate Car	162	08.01-01.05		<b>KV 276</b>
<b>KV 250</b>	CH--> 4B-2-031500	3.0 QUATTRO Limousine; 3.0 QUATTRO Estate Car	162	08.01-01.05		<b>KF 307</b>
<b>KV 250</b>	CH. 4B-2-031501 -->	3.0 QUATTRO Limousine; 3.0 QUATTRO Estate Car	162	08.01-01.05		<b>KF 307</b>
<b>KV 250</b>		3.0 QUATTRO Limousine; 3.0 QUATTRO Estate Car	162	08.01-01.05		<b>KF 307</b>

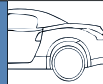
	<b>i</b>	<b>ENGINE</b>	<b>POWER (kW)</b>	<b>YEAR</b>	<b>i</b>	
Fersa KIT FRONT						Fersa KIT REAR
<b>AUDI</b>						
<b>A6 (4B,C5)</b>						
<b>KV 250</b>	CH--> 4B-2-031500	3.0 QUATTRO Limousine; 3.0 QUATTRO Estate Car	162	08.01-01.05		<b>KV 250</b>
<b>KV 250</b>	CH. 4B-2-031501 -->	3.0 QUATTRO Limousine; 3.0 QUATTRO Estate Car	162	08.01-01.05		<b>KV 250</b>
<b>KV 250</b>		3.0 QUATTRO Limousine; 3.0 QUATTRO Estate Car	162	08.01-01.05		<b>KV 250</b>
<b>KV 250</b>		3.7 Limousine; 3.7 Estate Car	191	03.99-01.05		<b>KV 276</b>
<b>KV 250</b>		3.7 QUATTRO Limousine; 3.7 QUATTRO Estate Car; 4.2 QUATTRO Limousine; 4.2 QUATTRO Estate Car; RS6 Limousine; RS6 Estate Car; RS6 plus Estate Car;	191-353	11.98-01.05		<b>KV 250</b>
<b>A6 (4A,C4)</b>						
		1.9 TDI Limousine; 1.9 TDI Estate Car	81	04.97-04.01		<b>KV 276</b>
<b>KV 250</b>	CH. 4B-2-031501 -->	1.9 TDI Limousine; 1.9 TDI Estate Car	85	07.00-01.05		<b>KV 276</b>
<b>KV 250</b>	09.01 --> / CH. --> 4B-2-031500	1.9 TDI Limousine; 1.9 TDI Estate Car	85	07.00-01.05		<b>KV 276</b>
<b>KV 250</b>	CH--> 4B-2-031500	1.9 TDI Limousine; 1.9 TDI Estate Car	96	08.01-01.05		<b>KV 276</b>
<b>KV 250</b>	CH. 4B-2-031501 -->	1.9 TDI Limousine; 1.9 TDI Estate Car	96	08.01-01.05		<b>KV 276</b>
<b>KV 250</b>	CH. 4B-2-031501 -->	2.5 TDI Limousine; 2.5 TDI Estate Car	110	07.97-01.05		<b>KV 276</b>
<b>KV 250</b>	09.01 --> / CH. --> 4B-2-031500	2.5 TDI Limousine; 2.5 TDI Estate Car	110	07.97-01.05		<b>KV 276</b>
<b>KV 250</b>	09.01 -->	2.5 TDI Limousine; 2.5 TDI Estate Car	110	07.97-01.05		<b>KV 276</b>
<b>KV 250</b>	CH. 4B-2-031501 -->	2.5 TDI QUATTRO Limousine	110	07.97-01.05		<b>KF 307</b>
<b>KV 250</b>	09.01 --> / CH. --> 4B-2-031500	2.5 TDI QUATTRO Limousine	110	07.97-01.05		<b>KF 307</b>
<b>KV 250</b>	09.01 -->	2.5 TDI QUATTRO Limousine	110	07.97-01.05		<b>KF 307</b>
		2.5 TDI QUATTRO Limousine	110	07.97-01.05	--> 08.01	<b>KF 098</b>
<b>KV 250</b>	09.01 --> / CH. --> 4B-2-031500	2.5 TDI QUATTRO Limousine	110	07.97-01.05	09.01 -->	<b>KV 250</b>
<b>KV 250</b>	09.01 -->	2.5 TDI QUATTRO Limousine	110	07.97-01.05	09.01 -->	<b>KV 250</b>
<b>KV 250</b>	CH. 4B-2-031501 -->	2.5 TDI QUATTRO Estate Car	110	12.97-01.05		<b>KF 307</b>
<b>KV 250</b>	09.01 --> / CH. --> 4B-2-031500	2.5 TDI QUATTRO Estate Car	110	12.97-01.05		<b>KF 307</b>
<b>KV 250</b>	09.01 -->	2.5 TDI QUATTRO Estate Car	110	12.97-01.05		<b>KF 307</b>
<b>KV 250</b>	09.01 --> / CH. --> 4B-2-031500	2.5 TDI QUATTRO Estate Car	110	12.97-01.05	09.01 -->	<b>KV 250</b>
<b>KV 250</b>	09.01 -->	2.5 TDI QUATTRO Estate Car	110	12.97-01.05	09.01 -->	<b>KV 250</b>
<b>KV 250</b>	CH--> 4B-2-031500	2.5 TDI Limousine; 2.5 TDI Estate Car	114-120	08.01-01.05		<b>KV 276</b>
<b>KV 250</b>	CH. 4B-2-031501 -->	2.5 TDI Limousine; 2.5 TDI Estate Car	114-120	08.01-01.05		<b>KV 276</b>
<b>KV 250</b>		2.5 TDI Limousine; 2.5 TDI Estate Car	114-120	08.01-01.05		<b>KV 276</b>
<b>KV 250</b>	CH. 4B-2-031501 -->	2.5 TDI Limousine; 2.5 TDI Estate Car	132	02.00-01.05		<b>KV 276</b>
<b>KV 250</b>	09.01 --> / CH. --> 4B-2-031500	2.5 TDI Limousine; 2.5 TDI Estate Car	132	02.00-01.05		<b>KV 276</b>
<b>KV 250</b>	09.01 -->	2.5 TDI Limousine; 2.5 TDI Estate Car	132	02.00-01.05		<b>KV 276</b>
<b>KV 250</b>	CH. 4B-2-031501 -->	2.5 TDI QUATTRO Limousine	132	02.00-01.05		<b>KF 307</b>
<b>KV 250</b>	09.01 --> / CH. --> 4B-2-031500	2.5 TDI QUATTRO Limousine	132	02.00-01.05		<b>KF 307</b>
<b>KV 250</b>	09.01 -->	2.5 TDI QUATTRO Limousine	132	02.00-01.05		<b>KF 307</b>
		2.5 TDI QUATTRO Limousine	132	02.00-01.05	--> 08.01	<b>KF 098</b>
<b>KV 250</b>	CH. 4B-2-031501 -->	2.5 TDI QUATTRO Limousine	132	02.00-01.05	09.01 -->	<b>KV 250</b>
<b>KV 250</b>	09.01 --> / CH. --> 4B-2-031500	2.5 TDI QUATTRO Limousine	132	02.00-01.05	09.01 -->	<b>KV 250</b>
<b>KV 250</b>	CH. 4B-2-031501 -->	2.5 TDI QUATTRO Estate Car	132	02.00-01.05		<b>KF 307</b>
<b>KV 250</b>	09.01 --> / CH. --> 4B-2-031500	2.5 TDI QUATTRO Estate Car	132	02.00-01.05		<b>KF 307</b>
<b>KV 250</b>	09.01 -->	2.5 TDI QUATTRO Estate Car	132	02.00-01.05		<b>KF 307</b>
<b>KV 250</b>	09.01 --> / CH. --> 4B-2-031500	2.5 TDI QUATTRO Estate Car	132	02.00-01.05	09.01 -->	<b>KV 250</b>
<b>KV 250</b>	09.01 -->	2.5 TDI QUATTRO Estate Car	132	02.00-01.05	09.01 -->	<b>KV 250</b>
<b>A8 (4D2,4D8)</b>						
<b>KF 308</b>	CH. --> 4D-T-007000	2.8	120-128	03.94-03.96		<b>KF 098</b>
<b>KF 308</b>	CH. --> 4D-T-007000	2.8 QUATTRO	120-128	03.94-03.96		<b>KF 098</b>
<b>KF 308</b>	CH. --> 4D-T-007000	2.8	142	04.96-09.02		
		2.8	142	04.96-09.02	CH. 4D-X-005000 -->	<b>KV 250</b>
		2.8	142	04.96-09.02	CH. --> 4D-X-005000	<b>KF 098</b>
<b>KF 308</b>	CH. --> 4D-T-007000	2.8 QUATTRO; 3.7	142-169	07.95-09.02		
		2.8 QUATTRO; 3.7	142-169	07.95-09.02	CH. --> 4D-X-005000	<b>KF 098</b>
		2.8 QUATTRO; 3.7	142-169	07.95-09.02	CH. 4D-X-005000 -->	<b>KV 250</b>
<b>KF 308</b>	CH. --> 4D-T-007000	3.7 QUATTRO	169	07.95-11.98		

 Fersa KIT FRONT	<b>i</b>	ENGINE	POWER (kW)	YEAR	<b>i</b>	Fersa KIT REAR 
<b>AUDI</b>						
<b>A8 (4D2,4D8)</b>						
<b>KV 250</b>	CH. 4D-X-005501 -->	3.7 QUATTRO	169	07.95-11.98		
		3.7 QUATTRO	169	07.95-11.98	CH. --> 4D-X-005000	<b>KF 098</b>
<b>KV 250</b>	CH. 4D-X-005501 -->	3.7 QUATTRO	169	07.95-11.98	CH. 4D-X-005000 -->	<b>KV 250</b>
		3.7	191	11.98-09.02	CH. --> 4D-X-005000	<b>KF 098</b>
<b>KV 250</b>	CH. 4D-X-005501 -->	3.7	191	11.98-09.02	CH. 4D-X-005000 -->	<b>KV 250</b>
		3.7 QUATTRO; 4.2 QUATTRO	175-191	11.98-09.02	CH. --> 4D-X-005000	<b>KF 098</b>
<b>KV 250</b>	CH. 4D-X-005501 -->	3.7 QUATTRO; 4.2 QUATTRO	175-191	11.98-09.02	CH. 4D-X-005000 -->	<b>KV 250</b>
<b>KF 308</b>	CH. --> 4D-T-007000	4.2 QUATTRO	180	03.94-07.96		<b>KF 098</b>
<b>KF 308</b>	CH. --> 4D-T-007000	4.2 QUATTRO	220	03.94-11.98		
<b>KV 250</b>	CH. 4D-X-005501 -->	4.2 QUATTRO	220	03.94-11.98		
		4.2 QUATTRO	220	03.94-11.98	CH. --> 4D-X-005000	<b>KF 098</b>
		4.2 QUATTRO	220	03.94-11.98	CH. 4D-X-005000 -->	<b>KV 250</b>
		4.2 QUATTRO	228	11.98-09.02	CH. --> 4D-X-005000	<b>KF 098</b>
<b>KV 250</b>	CH. 4D-X-005501 -->	4.2 QUATTRO	228	11.98-09.02	CH. 4D-X-005000 -->	<b>KV 250</b>
<b>KF 308</b>	CH. --> 4D-T-007000	S8 QUATTRO	250	07.96-06.99		
		S8 QUATTRO	250	07.96-06.99	CH. --> 4D-X-005000	<b>KF 098</b>
<b>KV 250</b>	CH. 4D-X-005501 -->	S8 QUATTRO	250	07.96-06.99	CH. 4D-X-005000 -->	<b>KV 250</b>
		S8 QUATTRO	265	06.99-09.02	CH. --> 4D-X-005000	<b>KF 098</b>
		S8 QUATTRO	265	06.99-09.02	CH. 4D-X-005000 -->	<b>KV 250</b>
<b>KV 250</b>	CH. 4D-X-005501 -->	6.0 W12 QUATTRO	309	01.01-09.02		<b>KV 250</b>
		2.5 TDI	110	01.97-04.00	CH. --> 4D-X-005000	<b>KF 098</b>
<b>A8 (4D2,4D8)</b>						
<b>KV 250</b>	CH. 4D-X-005501 -->	2.5 TDI	110	01.97-04.00	CH. 4D-X-005000 -->	<b>KV 250</b>
		2.5 TDI QUATTRO	110	07.97-04.00	CH. --> 4D-X-005000	<b>KF 098</b>
<b>KV 250</b>	CH. 4D-X-005501 -->	2.5 TDI QUATTRO	110	07.97-04.00	CH. 4D-X-005000 -->	<b>KV 250</b>
<b>KV 250</b>	CH. --> 4D-1-006000	2.5 TDI	132	09.00-09.02		<b>KV 250</b>
<b>KV 250</b>	CH. --> 4D-1-006000	2.5 TDI QUATTRO; 3.3 TDI QUATTRO	132-165	06.00-09.02		<b>KV 250</b>
<b>ALLROAD (4BH)</b>						
		2.7 T QUATTRO; 4.2 V8	184-220	05.00-08.05		<b>KF 307</b>
		2.5 TDI QUATTRO	120-132	05.00-08.05		<b>KF 307</b>
<b>CABRIOLET (8G7,B4)</b>						
<b>KF 096</b>		1.8; 2.0 E	85-92	01.93-08.00	CH. --> 8G-V-004799	<b>KA 005</b>
<b>KF 096</b>		1.8; 2.0 E	85-92	01.93-08.00	CH. 8G-V-004800 -->	<b>KA 248</b>
<b>KF 096</b>		2.0 16V; 2.3 E	98-103	05.91-07.96		<b>KA 005</b>
<b>KF 098</b>		2.6; 2.8	102-128	11.92-08.00	CH. --> 8G-V-004799	<b>KA 005</b>
<b>KF 098</b>		2.6; 2.8	102-128	11.92-08.00	CH. 8G-V-004800 -->	<b>KA 248</b>
<b>KF 096</b>		1.9 TDI	66	06.95-08.00	CH. --> 8G-V-004799	<b>KA 005</b>
<b>KF 096</b>		1.9 TDI	66	06.95-08.00	CH. 8G-V-004800 -->	<b>KA 248</b>
<b>COUPE (81,85)</b>						
<b>KF 095</b>		1.6; 1.8; 1.8 GT	55-82	07.80-10.88	DISC BRAKE	<b>KA 005</b>
<b>KF 095</b>		1.6; 1.8; 1.8 GT	55-82	07.80-10.88	DRUM BRAKE	<b>KA 006</b>
<b>KF 095</b>	DRUM BRAKE	1.6; 1.8, 2.0, 2.1	55-82	81-88		<b>KA 069</b>
<b>KF 095</b>		1.8 GT quattro	66-82	12.84-10.88		
<b>KF 095</b>		1.9; 2.0; 2.1 GT; 2.2 GT	79-100	08.80-10.88	DISC BRAKE	<b>KA 005</b>
<b>KF 095</b>		1.9; 2.0; 2.1 GT; 2.2 GT	79-100	08.80-10.88	DRUM BRAKE	<b>KA 006</b>
<b>KF 095</b>		2.2 QUATTRO	88-100	10.84-10.88		
<b>KF 095</b>		2.2 GT; 2.3	85-100	07.81-10.88	DISC BRAKE	<b>KA 005</b>
<b>KF 095</b>		2.2 GT; 2.3	85-100	07.81-10.88	DRUM BRAKE	<b>KA 006</b>
<b>KF 095</b>		2.3 QUATTRO	100	01.87-10.88		
<b>COUPE (89,8B)</b>						
<b>KF 096</b>		1.8; 2.0; 2.0 16V; 2.0 20 V	82-118	05.89-12.96	DISC BRAKE	<b>KA 005</b>
<b>KF 096</b>		2.0 20V QUATTRO; 2.2 QUATTRO	100-118	11.88-07.91		<b>KF 096</b>
<b>KF 098</b>		S2 QUATTRO	162-169	09.90-12.96		<b>KF 096</b>

		<b>i</b>	<b>ENGINE</b>	<b>POWER (kW)</b>	<b>YEAR</b>	<b>i</b>	
Fersa KIT FRONT							Fersa KIT REAR
<b>AUDI</b>							
<b>COUPE (89,8B)</b>							
<b>KF 096</b>			2.3	98-100	10.88-12.96	DISC BRAKE	<b>KA 005</b>
<b>KF 096</b>			2.3 QUATTRO	98-100	11.88-12.96		<b>KF 096</b>
<b>KF 098</b>			2.3 20V QUATTRO	123-125	11.88-12.96		<b>KF 096</b>
<b>KF 098</b>			2.3 20V QUATTRO	123-125	11.88-12.96	DISC BRAKE	<b>KA 005</b>
<b>KF 098</b>			2.3 20V	123-125	08.89-07.91	DISC BRAKE	<b>KA 005</b>
<b>KF 098</b>			2.6	110	08.92-12.96		
<b>KF 098</b>			2.6 QUATTRO	110	08.92-12.96		<b>KF 096</b>
<b>KF 098</b>			2.8 QUATTRO	128	08.91-12.96		<b>KF 096</b>
<b>KF 098</b>			2.8	128	09.91-12.96	DISC BRAKE	<b>KA 005</b>
<b>TT (8N03.8N9)</b>							
<b>KF 184</b>			1.8 T; 1.8 T QUATTRO	110-165	10.98-		<b>KV 194</b>
<b>KF 184</b>			1.8 T; 1.8 T QUATTRO	110-165	99-		<b>KV 097</b>
<b>V8 (D1)</b>							
<b>KF 098</b>			3.6 QUATTRO; 4.2 QUATTRO	180-206	10.88-02.94		<b>KF 098</b>
<b>AUSTIN</b>							
<b>MINI MK I</b>							
<b>KA 254</b>	CH. 239251 -->		1000 Mayfair	31	08.82-06.93		
<b>KA 254</b>	CH. 239251 -->		1000	26-29	10.67-09.84		
<b>KA 254</b>			1000 Mayfair Sport	30	09.88-06.93		
<b>KA 254</b>			1275 GT	39	10.69-08.80		
<b>AUTOBIANCHI</b>							
<b>A 112</b>							
<b>KF 161</b>	--> 01.77		0.9 Junior	31	07.75-12.85	--> 01.77 / 05.84 -->	<b>KV 162</b>
<b>KF 161</b>	--> 01.77		0.9; 0.9 E	33-34	01.73-12.78	--> 01.77	<b>KV 162</b>
<b>KF 161</b>			1.0 E,Elite,LX	35	11.77-12.85	05.84 -->	<b>KV 162</b>
<b>KF 161</b>	--> 01.77		1.0 Abarth	51	01.74-12.84	--> 01.77 / 05.84 -->	<b>KV 162</b>
<b>BMW</b>							
<b>3 (E21)</b>							
<b>KV 105</b>			315 Limousine	55	09.82-10.83	<b>ABS</b>	<b>KF 104</b>
<b>KV 105</b>			316i Limousine	73	09.87-06.91	ABS	<b>KF 106</b>
<b>KV 105</b>			316i Limousine	73	09.87-06.91	<b>ABS</b>	<b>KF 104</b>
<b>KV 105</b>			316i Estate Car	73	09.91-06.94	ABS	<b>KF 106</b>
<b>KV 105</b>			316i Limousine	75	07.88-06.91	ABS	<b>KF 106</b>
<b>KV 105</b>			316i Limousine	75	07.88-06.91	<b>ABS</b>	<b>KF 104</b>
<b>KV 105</b>			316i Estate Car	75	09.91-06.94	ABS	<b>KF 106</b>
<b>KV 105</b>			316 Limousine; 316 (Ecotronic) Limousine	66	09.82-12.90	<b>ABS</b>	<b>KF 104</b>
<b>KV 105</b>			316 Limousine; 316 (Ecotronic) Limousine	66	09.82-12.90	<b>ABS</b> / --> 08.85	<b>KF 104</b>
<b>KV 105</b>			316 Limousine; 316 (Ecotronic) Limousine	66	09.82-12.90	ABS / 09.85 -->	<b>KF 106</b>
<b>KV 105</b>			316 i 1.8 Limousine	75	08.87-08.88	ABS	<b>KF 106</b>
<b>KV 105</b>			316 i 1.8 Limousine	75	08.87-08.88	<b>ABS</b>	<b>KF 104</b>
<b>KV 105</b>			318i Limousine	75-77	09.82-08.88	<b>ABS</b> / --> 08.85	<b>KF 104</b>
<b>KV 105</b>			318i Limousine	75-77	09.82-08.88	ABS / 09.85 -->	<b>KF 106</b>
<b>KV 105</b>			318i Limousine	75-77	09.82-08.88	<b>ABS</b>	<b>KF 104</b>
<b>KV 105</b>			318i Limousine	83	09.87-06.91	ABS	<b>KF 106</b>
<b>KV 105</b>			318i Limousine	83	09.87-06.91	<b>ABS</b>	<b>KF 104</b>
<b>KV 105</b>			318i Estate Car; 318i Convertible	83	04.89-06.94	ABS	<b>KF 106</b>

	<b>i</b>	<b>ENGINE</b>	<b>POWER (kW)</b>	<b>YEAR</b>	<b>i</b>	
Fersa KIT FRONT						Fersa KIT REAR
<b>BMW</b>						
<b>3 (E21)</b>						
<b>KV 105</b>		318i Limousine	85	09.87-06.91	ABS	<b>KF 106</b>
<b>KV 105</b>		318i Limousine	85	09.87-06.91	<del>ABS</del>	<b>KF 104</b>
<b>KV 105</b>		318i Estate Car; 318is Limousine	85-100	09.87-08.91	ABS	<b>KF 106</b>
<b>KV 105</b>		320i Limousine	92	09.82-12.85	<del>ABS</del>	<b>KF 104</b>
<b>KV 105</b>		320i Limousine	92	09.82-12.85	<del>ABS</del> / --> 08.85	<b>KF 104</b>
<b>KV 105</b>		320i Limousine	92	09.82-12.85	ABS / 09.85 -->	<b>KF 106</b>
<b>KV 105</b>		320i Convertible	95	04.86-10.93	ABS	<b>KF 106</b>
<b>KV 105</b>		320i Limousine	110	12.85-06.90	ABS	<b>KF 106</b>
<b>KV 105</b>		320i Limousine	110	12.85-06.90	<del>ABS</del>	<b>KF 104</b>
<b>KV 105</b>		320is Limousine	141	05.88-12.90	ABS	<b>KF 106</b>
<b>KV 105</b>		320i Limousine	95	12.85-06.91	ABS	<b>KF 106</b>
<b>KV 105</b>		320i Limousine	95	12.85-06.91	<del>ABS</del>	<b>KF 104</b>
<b>KV 105</b>		320i Estate Car	95	01.88-12.91	ABS	<b>KF 106</b>
<b>KV 105</b>		323i Limousine	102	09.82-08.83		<b>KF 104</b>
<b>KV 105</b>		323i Limousine	110	09.83-08.86	--> 08.85	<b>KF 104</b>
<b>KV 105</b>		323i Limousine	110	09.83-08.86	09.85 -->	<b>KF 106</b>
		M3 2.5 EVO II Limousine	175	01.90-01.92		<b>KF 106</b>
<b>3 (E30)</b>						
<b>KV 103</b>		316	73	82-92		<b>KF 104</b>
<b>KV 103</b>		318i	103	83-90		<b>KF 104</b>
<b>KV 103</b>	ABS	318i Touring	103	88-91	ABS	<b>KF 106</b>
<b>KV 103</b>		318is	103	08.89-90		<b>KF 106</b>
<b>KV 103</b>		320i	110-125	82-92		<b>KF 104</b>
<b>KV 103</b>		320i Touring	110-125	88-91		<b>KF 106</b>
<b>KV 103</b>		320ic	110-125	83-90		<b>KF 104</b>
<b>KV 103</b>		323i	125	81-09.85		<b>KF 104</b>
<b>KV 103</b>		323i	125	09.85-87		<b>KF 106</b>
<b>KV 103</b>		324 D	63	09.85-90		<b>KF 104</b>
<b>KV 103</b>		324 TD	85	09.85-90		<b>KF 106</b>
<b>KV 103</b>		324 TD TOURING	85	88-91		<b>KF 106</b>
<b>KV 103</b>		325e	90-95	83-08.85		<b>KF 104</b>
<b>KV 103</b>		325e	90-95	09.85-90		<b>KF 106</b>
<b>KV 103</b>		325i	90-95	83-05.85		<b>KF 104</b>
<b>KV 103</b>		325i	90-95	09.85-90		<b>KF 106</b>
<b>KV 103</b>		325ic	90-95	83-90		<b>KF 106</b>
<b>KV 105</b>		325i Limousine; 325i Estate Car; 325i Convertible	125-126	09.83-10.93	ABS	<b>KF 106</b>
<b>KV 105</b>		325iX Limousine; 325iX Estate Car	125-126	03.86-10.93	ABS	<b>KF 106</b>
<b>KV 105</b>		325e 2.7 Limousine	90-95	10.83-12.88	--> 08.85	<b>KF 104</b>
<b>KV 105</b>		325e 2.7 Limousine	90-95	10.83-12.88	09.85 -->	<b>KF 106</b>
<b>KV 105</b>		324d Limousine	63	09.85-08.91	ABS	<b>KF 106</b>
<b>KV 105</b>		324d Limousine	63	09.85-08.91	NO ABS	<b>KF 104</b>
<b>KV 105</b>		324td Limousine; 324td Estate Car	85	09.87-06.93	ABS	<b>KF 106</b>
<b>3 (E36)</b>						
<b>KV 105</b>		316i Limousine	73	09.90-09.93	DISC BRAKE	<b>KF 110</b>
<b>KV 105</b>		316i Limousine	73	09.90-09.93		<b>KF 109</b>
<b>KV 105</b>		316i Limousine	73	09.90-09.93		
<b>KV 105</b>		316i Limousine	75	09.90-02.98	DISC BRAKE	<b>KF 110</b>
<b>KV 105</b>		316i Limousine	75	09.90-02.98		<b>KF 109</b>
<b>KV 297</b>		316i Limousine	75	09.90-02.98		
<b>KV 297</b>		316g Hatchback	75	12.95-08.00		
<b>KV 297</b>		316i Estate Car; 316i Coupe; 318i Limousine; 318i Estate Car; 318i Convertible; 318is Limousine; 318is Coupe	75-103	12.90-10.99	DISC BRAKE	<b>KF 110</b>

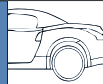
	<b>i</b>	<b>ENGINE</b>	<b>POWER (kW)</b>	<b>YEAR</b>	<b>i</b>	
Fersa KIT FRONT						Fersa KIT REAR
<b>BMW</b>						
<b>3 (E36)</b>						
<b>KV 297</b>		316i Estate Car; 316i Coupe; 318i Limousine; 318i Estate Car; 318i Convertible; 318is Limousine; 318is Coupe	75-103	12.90-10.99		<b>KF 109</b>
<b>KV 297</b>		316i Hatchback; 318ti Hatchback	77-103	11.94-08.00		
<b>KV 297</b>		318ti Hatchback	103	07.95-08.00		
<b>KV 297</b>		318is Limousine; 318is Coupe	103	09.95-04.99	DISC BRAKE	<b>KF 110</b>
<b>KV 297</b>		318is Limousine; 318is Coupe	103	09.95-04.99		<b>KF 109</b>
<b>KV 297</b>		320i Limousine; 320i Estate Car; 320i Coupe; 320i Convertible; 323i Limousine; 323i Coupe; 323i 2.5 Estate Car; 323i 2.5 Convertible	110-125	09.90-10.99	DISC BRAKE	<b>KF 110</b>
<b>KV 297</b>		320i Limousine; 320i Estate Car; 320i Coupe; 320i Convertible; 323i Limousine; 323i Coupe; 323i 2.5 Estate Car; 323i 2.5 Convertible	110-125	09.90-10.99		<b>KF 109</b>
<b>KV 297</b>		323ti Hatchback	125	08.97-08.00	ABS	<b>KF 106</b>
<b>KV 297</b>		325i Limousine; 325i Cabriolet Convertible; 325i Coupe Coupe	141	09.90-04.99	DISC BRAKE	<b>KF 110</b>
<b>KV 297</b>		325i Limousine; 325i Cabriolet Convertible; 325i Coupe Coupe	141	09.90-04.99		<b>KF 109</b>
<b>KV 297</b>		328i Limousine; 328i Estate Car; 328i Coupe; 328i Convertible	142	01.95-10.99	DISC BRAKE	<b>KF 110</b>
<b>KV 297</b>		M3 Coupe; M3 3.0 Limousine; M3 3.0 Coupe; M3 3.0 Convertible; M3 3.2 Limousine; M3 3.2 Convertible	210-236	10.92-04.99		<b>KF 274</b>
<b>KV 297</b>		318tds Limousine	66	01.95-02.98	DISC BRAKE	<b>KF 110</b>
<b>KV 297</b>		318tds Limousine	66	01.95-02.98		<b>KF 109</b>
<b>KV 297</b>		318tds Estate Car; 325td Limousine; 325tds Limousine; 325tds Estate Car	66-105	09.91-10.99	DISC BRAKE	<b>KF 110</b>
<b>KV 297</b>		318tds Estate Car; 325td Limousine; 325tds Limousine; 325tds Estate Car	66-105	09.91-10.99		<b>KF 109</b>
<b>3 (E46)</b>						
<b>KV 297</b>		316Ci; 316i; 316ti; 318Ci; 318i; 318ti; 320Ci; 320i; 323Ci; 323i; 325Ci; 325i; 325ti	77-141	02.98-	DISC BRAKE	<b>KF 110</b>
		325xi	141	09.00-02.05		<b>KF 274</b>
<b>KV 297</b>		328i	142	02.98-06.00	DISC BRAKE	<b>KF 110</b>
<b>KV 297</b>		330Ci Convertible; 330i	170	06.00-		<b>KF 274</b>
		330Ci Coupe; 330xi	170	06.00-		<b>KF 274</b>
		M3 3.2; M3 CSL	252-265	06.00-		<b>KF 274</b>
		318d; 318td; 320Cd; 320d; 320td	85-110	04.98-	DISC BRAKE	<b>KF 110</b>
<b>KV 297</b>		318d; 318td; 320Cd; 320d; 320td	85-110	04.98-		
<b>KV 297</b>		330d	135	10.99-02.05		<b>KF 274</b>
		330xd	135	06.00-02.05		<b>KF 274</b>
<b>KV 297</b>		330Cd; 330d	150	03.03-		<b>KF 274</b>
		330xd	150	03.03-02.05		<b>KF 274</b>
<b>5 (E28)</b>						
		518; 518i	66-77	06.81-12.87	ABS	<b>KF 107</b>
		520i	92-95	06.81-12.87	ABS	<b>KF 107</b>
		520i	92-95	06.81-12.87	ABS / 09.86 -->	<b>KF 107</b>
		520i	110	12.86-06.90	ABS	<b>KF 107</b>
		525e 2.7; 525i	90-110	06.81-12.87	ABS / 09.86 -->	<b>KF 107</b>
		524td	85	09.83-12.87	ABS	<b>KF 107</b>
		524td	85	09.83-12.87	ABS / 09.86 -->	<b>KF 107</b>
<b>5 (E34)</b>						
<b>KV 108</b>	ABS / 11.91 -->	518i Limousine	83	08.89-09.95		<b>KF 107</b>
<b>KV 108</b>	ABS / 03.91 -->	518i Limousine	83	08.89-09.95		<b>KF 107</b>
<b>KV 108</b>		518g Estate Car; 518i Estate Car	83-85	03.93-06.96		



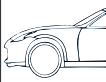
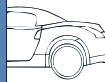

	<b>i</b>	<b>ENGINE</b>	<b>POWER (kW)</b>	<b>YEAR</b>	<b>i</b>	
Fersa KIT FRONT						Fersa KIT REAR
<b>BMW</b>						
<b>5 (E34)</b>						
<b>KV 108</b>	ABS / 11.91 -->	518i Limousine	85	08.89-09.95		<b>KF 107</b>
<b>KV 108</b>	<del>ABS</del> / 03.91 -->	518i Limousine	85	08.89-09.95		<b>KF 107</b>
<b>KV 108</b>		518i Estate Car	85	09.94-01.97		<b>KF 107</b>
<b>KV 108</b>	<del>ABS</del> / 03.91 -->	520i Limousine	95	01.88-08.91		
<b>KV 108</b>	ABS / 11.91 -->	520i 24V Limousine	110	09.89-09.95		<b>KF 107</b>
<b>KV 108</b>	<del>ABS</del> / 03.91 -->	520i 24V Limousine	110	09.89-09.95		<b>KF 107</b>
<b>KV 108</b>		520i Estate Car	110	11.91-01.97		<b>KF 107</b>
<b>KV 108</b>	<del>ABS</del> / 03.91 -->	525i Limousine	125	01.88-08.91		
<b>KV 108</b>	ABS / 11.91 -->	525i 24V Limousine	141	09.89-09.95		<b>KF 107</b>
<b>KV 108</b>	<del>ABS</del> / 03.91 -->	525i 24V Limousine	141	09.89-09.95		<b>KF 107</b>
		525iX 24V Limousine	141	10.91-09.95		<b>KF 107</b>
<b>KV 108</b>		525i Estate Car	141	11.91-01.97		<b>KF 107</b>
<b>KV 108</b>	<del>ABS</del> / 03.91 -->	530i Limousine	138	01.88-08.91		<b>KF 107</b>
<b>KV 108</b>		530i V8 Limousine	160	09.92-09.95		
<b>KV 108</b>		530i V8 Estate Car	160	09.92-01.97		
<b>KV 108</b>	ABS / 11.91 -->	535i Limousine	155	01.88-09.95		<b>KF 107</b>
<b>KV 108</b>	<del>ABS</del> / 03.91 -->	535i Limousine	155	01.88-09.95		<b>KF 107</b>
<b>KV 108</b>		540i Estate Car; 540i V8 Limousine	210	09.92-01.97		
<b>KV 108</b>	ABS / 11.91 -->	524td Limousine	85	03.88-09.95		<b>KF 107</b>
<b>KV 108</b>	<del>ABS</del> / 03.91 -->	524td Limousine	85	03.88-09.95		<b>KF 107</b>
<b>KV 108</b>		525td Estate Car	85	03.93-01.97		<b>KF 107</b>
<b>KV 108</b>		525td Limousine	85	04.93-09.95		
<b>KV 108</b>	ABS / 11.91 -->	525tds Limousine	105	09.91-09.95		<b>KF 107</b>
<b>KV 108</b>		525tds Limousine	105	09.91-09.95		<b>KF 107</b>
<b>KV 108</b>		525tds Estate Car	105	12.91-01.97		
<b>5 (E39)</b>						
<b>KV 238</b>		520i; 523i; 525i; 528i; 530i; 535i; 540i	100-210	11.95-05.04		<b>KV 239</b>
		M5	230-294	09.98-06.03		<b>KV 239</b>
<b>KV 238</b>		520d; 525d; 525td; 525tds; 530d	85-142	01.96-05.04		<b>KV 239</b>
<b>7 (E32)</b>						
<b>KV 108</b>	--> 02.92	730i,iL	138-145	12.86-09.94		
<b>KV 108</b>	11.91 -->	730i,iL	138-145	12.86-09.94		
<b>KV 108</b>		730i,iL V8	160	04.92-09.94		
<b>KV 108</b>	--> 02.92	735i,iL	155	09.86-09.92		
<b>KV 108</b>	11.91 -->	735i,iL	155	09.86-09.92		
<b>KV 108</b>		740i,iL V8	210	04.92-09.94		
<b>KV 108</b>	--> 02.92	750i,iL V12	220	09.87-09.94		
<b>KV 108</b>	11.91 -->	750i,iL V12	220	09.87-09.94		
<b>7 (E38)</b>						
		728i,iL; 730i,iL; 735i,iL; 740i,iL; 750i,iL	142-240	10.94-11.01		<b>KF 274</b>
		725tds; 730d; 740d	105-180	04.96-11.01		<b>KF 274</b>
<b>8 (E31)</b>						
<b>KV 108</b>		840Ci	210	02.93-12.99		<b>KF 274</b>
<b>KV 108</b>	--> 04.92	850i,Ci	220	04.90-10.94		<b>KF 274</b>
<b>KV 108</b>	--> 03.92	850i,Ci	220	04.90-10.94		<b>KF 274</b>
<b>KV 108</b>		850Ci	240	09.94-12.99		<b>KF 274</b>
		850CSi	280	04.93-12.96		<b>KF 274</b>
<b>X3 (E83)</b>						
		2.0i; 2.5; 2.5 si; 3.0; 3.0 si	110-200	01.04-		<b>KF 274</b>
		2.0 d; 2.0d; 3.0 sd; 3.0d	110-210	01.04-		<b>KF 274</b>

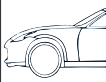
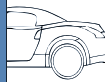
	<b>i</b>	ENGINE	POWER (kW)	YEAR	<b>i</b>	
Fersa KIT FRONT						Fersa KIT REAR
<b>BMW</b>						
<b>Z1</b>						
<b>KV 105</b>		2.5	125	06.88-06.91	--> 09.90	<b>KF 110</b>
<b>KV 105</b>		2.5	125	06.88-06.91	09.90 -->	<b>KF 303</b>
<b>Z3</b>						
<b>KV 297</b>		1.8	85	10.95-10.98		
<b>KV 297</b>		1.9	85	01.99-01.03	09.90 -->	<b>KF 303</b>
<b>KV 297</b>		1.9	87	07.98-01.03	04.99 -->	<b>KF 303</b>
<b>KV 297</b>		1.9	103	10.95-03.99		
<b>KV 297</b>		2.0; 2.2; 2.8; 3.0	110-170	04.97-06.03		<b>KF 303</b>
<b>KV 297</b>		M 3.2	236-239	03.97-06.03		<b>KF 274</b>
<b>Z4 (E85)</b>						
<b>KV 297</b>		2.0i; 2.2i; 2.5i; 3.0i	110-170	02.03-	DISC BRAKE	<b>KF 110</b>
<b>Z8 (E52)</b>						
<b>KV 238</b>		4.9	294	06.00-06.03		<b>KF 274</b>
<b>CITROËN</b>						
<b>AX</b>						
<b>KF 111</b>		1.3 Sport; 10; 10 E; 11; 14	30-70	07.86-12.98		<b>KF 112</b>
<b>KF 142</b>		14 4x4	55	08.91-12.96		<b>KF 111</b>
<b>KF 111</b>		14	55-62	04.87-04.97		<b>KF 112</b>
<b>KF 142</b>		14	55-62	04.87-04.97		<b>KF 112</b>
<b>KF 142</b>		1.4 GTi	66-69	06.91-12.96		<b>KB 008</b>
<b>KF 111</b>		1.4 GTi	74	06.91-12.92		<b>KV 144</b>
<b>KF 142</b>		1.4 GTi	74	06.91-12.92		<b>KV 144</b>
<b>KF 142</b>		14 D	37	08.91-12.97		<b>KB 008</b>
<b>KF 111</b>		14 D	38	09.88-06.92		<b>KF 112</b>
<b>KF 142</b>		14 D	38	09.88-06.92		<b>KF 112</b>
<b>KF 142</b>		15 D	40	08.94-12.97		<b>KF 112</b>
<b>KF 142</b>		15 D	43	08.94-12.97		<b>KF 112</b>
<b>AXEL</b>						
<b>KF 142</b>		11	42-45	01.84-03.91		
<b>BERLINGO</b>						
<b>KF 143</b>		Electric Bus	16	01.00-	<b>ABS</b>	<b>KV 114</b>
<b>KF 143</b>		Electric	27	11.04-		
<b>KF 143</b>		Electric	27	11.04-	<b>ABS</b>	<b>KV 114</b>
<b>KF 143</b>		Electric	27	11.02-	<b>ABS</b>	<b>KV 114</b>
<b>KF 143</b>		1.1i; 1.1i Bus	44	07.96-	<b>ABS</b>	<b>KV 114</b>
<b>KF 143</b>		1.4; 1.4 bivalent; 1.4 GNC; 1.4 i bivalent Bus; 1.4 i bivalent Box Wagon	48-55	11.02-	<b>ABS</b>	<b>KV 114</b>
<b>KF 143</b>		1.4	54	05.05-		
<b>KF 143</b>		1.4	54	05.05-	<b>ABS</b>	<b>KV 114</b>
<b>KF 143</b>		1.4i Bus; 1.4i Box Wagon	55	07.96-	<b>ABS</b>	<b>KV 114</b>
<b>KF 143</b>		1.6; 1.6 16V; 1.6 16V Bus	80	10.00-	<b>ABS</b>	<b>KV 114</b>
<b>KF 143</b>		1.8i; 1.8i Bus	66	04.97-	<b>ABS</b>	<b>KV 114</b>
<b>KF 143</b>		1.8 i	66	08.99-10.02	<b>ABS</b>	<b>KV 114</b>
<b>KF 143</b>		1.6 HDi; 1.6 HDI 75; 1.6 HDI 90	55-80	07.05-	<b>ABS</b>	<b>KV 114</b>
<b>KF 143</b>		1.8 D Bus; 1.8 D Box Wagon	43	07.96-	<b>ABS</b>	<b>KV 114</b>
<b>KF 143</b>		1.8 X	44	11.96-10.99	<b>ABS</b>	<b>KV 114</b>
<b>KF 143</b>		1.9 D Bus	51	07.98-	<b>ABS</b>	<b>KV 114</b>
<b>KF 143</b>		1.9 D Box Wagon	51	04.99-	<b>ABS</b>	<b>KV 114</b>
<b>KF 143</b>		1.9 D; 1.9 D Bus; 1.9 D 4WD Box Wagon	50-51	07.96-	<b>ABS</b>	<b>KV 114</b>

	<b>i</b>	<b>ENGINE</b>	<b>POWER (kW)</b>	<b>YEAR</b>	<b>i</b>	
Fersa KIT FRONT						Fersa KIT REAR
<b>CITROËN</b>						
<b>BERLINGO</b>						
<b>KF 143</b>		1.9 D	51	07.96-10.99	<b>ABS</b>	<b>KV 114</b>
<b>KF 143</b>		1.9 D Box Wagon	51	07.96-	<b>ABS</b>	<b>KV 114</b>
<b>KF 143</b>		2.0 HDi; 2.0 HDi 4x4; 2.0 HDi 90 Bus; 2.0 HDi 90 Box Wagon; 2.0 HDi 90 4WD	66	12.99-	<b>ABS</b>	<b>KV 114</b>
<b>BX</b>						
<b>KF 143</b>		11 Hatchback	40-42	10.86-06.92	<b>ABS</b>	<b>KV 144</b>
<b>KF 143</b>	09.84 -->	14 E Hatchback	45	10.82-06.88	<b>ABS</b>	<b>KV 144</b>
<b>KF 143</b>		14 Hatchback; 14 Estate Car; 14 E Hatchback	47-49	09.85-02.93	<b>ABS</b>	<b>KV 144</b>
<b>KF 143</b>	09.84 -->	14 E Hatchback	52	04.83-07.89		
<b>KF 143</b>	09.84 -->	14 E Hatchback	53	04.83-02.93		
<b>KF 143</b>		14 Estate Car	53	01.86-02.93	<b>ABS</b>	<b>KV 144</b>
<b>KF 143</b>		14 Hatchback; 14 Estate Car; 14 E Hatchback; 15 Hatchback; 15 Estate Car; 16 Hatchback; 16 Estate Car; 16 E Hatchback	53-65	07.85-12.94	<b>ABS</b>	<b>KV 215</b>
<b>KF 143</b>		14 Hatchback; 14 Estate Car; 14 E Hatchback; 15 Hatchback; 15 Estate Car; 16 Hatchback; 16 Estate Car; 16 E Hatchback	53-65	07.85-12.94	<b>ABS</b>	<b>KV 144</b>
<b>KF 143</b>	09.84 -->	16 Hatchback	66	10.82-06.88		
		16 Hatchback	66	10.82-06.88	<b>ABS</b>	<b>KV 215</b>
		16 Hatchback	66	10.82-06.88	<b>ABS</b>	<b>KV 144</b>
<b>KF 143</b>		16 Estate Car	66	06.85-06.88	<b>ABS</b>	<b>KV 144</b>
<b>KF 143</b>		16 Estate Car	66	06.85-06.88	<b>ABS</b>	<b>KV 215</b>
<b>KF 143</b>	09.84 -->	16 Hatchback	68	10.82-12.92		
		16 Hatchback	68	10.82-12.92	<b>ABS</b>	<b>KV 215</b>
		16 Hatchback	68	10.82-12.92	<b>ABS</b>	<b>KV 144</b>
<b>KF 143</b>		16 Hatchback; 16 Estate Car; 19 Hatchback; 19 Estate Car; 19 E Hatchback; 19 GTi Hatchback	70-90	03.86-12.94	<b>ABS</b>	<b>KV 215</b>
<b>KF 143</b>		16 Hatchback; 16 Estate Car; 19 Hatchback; 19 Estate Car; 19 E Hatchback; 19 GTi Hatchback	70-90	03.86-12.94	<b>ABS</b>	<b>KV 144</b>
<b>KF 143</b>		19 4x4 Estate Car; 19 E 4x4 Hatchback; 19 GTi 4x4 Hatchback	80-88	06.88-02.93		<b>KF 143</b>
<b>KF 143</b>		19 GTi 16V Hatchback	108-116	09.87-02.93		
<b>KF 143</b>		18 D Hatchback; TRD TURBO Hatchback; TRD TURBO Estate Car	44-66	10.85-12.94	<b>ABS</b>	<b>KV 215</b>
<b>KF 143</b>		18 D Hatchback; TRD TURBO Hatchback; TRD TURBO Estate Car	44-66	10.85-12.94	<b>ABS</b>	<b>KV 144</b>
<b>KF 143</b>	09.84 -->	19 D Hatchback; 19 D Estate Car	47	09.83-12.87		
		19 D Hatchback; 19 D Estate Car	47	09.83-12.87	<b>ABS</b>	<b>KV 215</b>
		19 D Hatchback; 19 D Estate Car	47	09.83-12.87	<b>ABS</b>	<b>KV 144</b>
<b>KF 143</b>		19 D Hatchback; 19 D Estate Car	51	03.87-12.94	<b>ABS</b>	<b>KV 215</b>
<b>KF 143</b>		19 D Hatchback; 19 D Estate Car	51	03.87-12.94	<b>ABS</b>	<b>KV 144</b>
<b>C2</b>						
<b>KF 354</b>	<b>ABS</b>	1.1; 1.4; 1.4 16V; 1.6; 1.6 VTS	44-90	09.03-		
<b>KF 145</b>	<b>ABS</b>	1.1; 1.4; 1.4 16V; 1.6; 1.6 VTS	44-90	09.03-		
<b>KF 354</b>	<b>ABS</b>	1.4 HDi	50	09.03-		
<b>KF 145</b>	<b>ABS</b>	1.4 HDi	50	09.03-		
<b>KF 145</b>	<b>ABS</b>	1.4 HDi	50	09.03-		
<b>C3</b>						
<b>KF 354</b>	<b>ABS</b>	1.1i; 1.4; 1.4 16V; 1.4 i; 1.6; 1.6 16V	44-80	02.02-		
<b>KF 145</b>	<b>ABS</b>	1.1i; 1.4; 1.4 16V; 1.4 i; 1.6; 1.6 16V	44-80	02.02-		
<b>KF 145</b>	<b>ABS</b>	1.1i; 1.4; 1.4 16V; 1.4 i; 1.6; 1.6 16V	44-80	02.02-		
<b>KF 354</b>	<b>ABS</b>	1.4 16V HDi; 1.4 HDi; 1.6 16V HDi	50-80	02.02-		
<b>KF 145</b>	<b>ABS</b>	1.4 16V HDi; 1.4 HDi; 1.6 16V HDi	50-80	02.02-		
<b>KF 145</b>	<b>ABS</b>	1.4 16V HDi; 1.4 HDi; 1.6 16V HDi	50-80	02.02-		

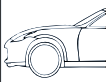
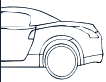
	<b>i</b>	<b>ENGINE</b>	<b>POWER (kW)</b>	<b>YEAR</b>	<b>i</b>	
Fersa KIT FRONT						Fersa KIT REAR
<b>CITROËN</b>						
<b>C4</b>						
<b>KF 289</b>		1.4 16V	65	11.04-	01.07 -->	<b>KV 290</b>
<b>KF 289</b>		1.6 16V Bio-Flex	80	09.07-		<b>KV 290</b>
<b>KF 289</b>		1.6 16V; 2.0 16V	80-130	11.04-	01.07 -->	<b>KV 290</b>
<b>KF 289</b>		1.6 HDi 90; 1.6 HDi 110 FAP; 2.0 HDi 135 FAP; 2.0 HDi 135 FFAP	66-100	11.04-	01.07 -->	<b>KV 290</b>
<b>C5</b>						
<b>KF 289</b>		1.8 16V Hatchback; 1.8 16V Estate Car; 2.0 16V Hatchback; 2.0 16V Estate Car; 2.0 16V HPI Hatchback; 2.0 16V HPI Estate Car; 3.0 Carlsson HP;	85-173	03.01-08.04		
<b>KF 289</b>		2.0 HDi; 2.0 HDi Hatchback; 2.0 HDi Estate Car; 2.2 HDi Hatchback; 2.2 HDi Estate Car	66-98	03.01-08.04		
<b>C8</b>						
		2.0; 2.2	100-116	07.02-		<b>KV 294</b>
<b>KA 091</b>		3.0 V6	150	07.02-		<b>KV 294</b>
		2.0 HDi; 2.2 HDi	79-94	07.02-		<b>KV 294</b>
<b>C15</b>						
<b>KF 142</b>		1.0; 1.0 E; 1.1; 1.1i; 1.3; 1.4; 1.4 E; 1.4i	33-55	10.84-12.97		<b>KV 144</b>
<b>KF 142</b>		1.8 D; 1.9 D	44	07.86-12.05		<b>KV 144</b>
<b>C25</b>						
<b>KA 009</b>	CH. --> 604496	1.8 E Bus; 2.0 E Bus; 2.0 E Box Wagon	51-58	09.81-03.94		
<b>KA 079</b>	CH. 604497 -->	1.8 E Bus; 2.0 E Bus; 2.0 E Box Wagon	51-58	09.81-03.94		
		1.8 E Bus; 2.0 E Bus; 2.0 E Box Wagon	51-58	09.81-03.94	CH. --> 278757 / 1000*1300[kg]	<b>KA 010</b>
		1.8 E Bus; 2.0 E Bus; 2.0 E Box Wagon	51-58	09.81-03.94	CH. 278758 --> / 1000[kg]	<b>KA 058</b>
		1.8 E Bus; 2.0 E Bus; 2.0 E Box Wagon	51-58	09.81-03.94	1400[kg]	<b>KA 058</b>
		1.8 E Bus; 2.0 E Bus; 2.0 E Box Wagon	51-58	09.81-03.94	1800[kg]	<b>KA 200</b>
<b>KA 079</b>		2.0; 2.0 Bus; 2.0 Box Wagon	62	02.91-03.94		
		2.0; 2.0 Bus; 2.0 Box Wagon	62	02.91-03.94	1000*1400[kg]	<b>KA 058</b>
		2.0; 2.0 Bus; 2.0 Box Wagon	62	02.91-03.94	1800[kg]	<b>KA 200</b>
<b>KA 009</b>	CH. --> 604496	1.9 D Bus	51	07.87-02.94		
<b>KA 079</b>	CH. 604497 -->	1.9 D Bus	51	07.87-02.94		
		1.9 D Bus	51	07.87-02.94	CH. --> 278757 / 1000*1300[kg]	<b>KA 010</b>
		1.9 D Bus	51	07.87-02.94	CH. 278758 --> / 1000[kg]	<b>KA 058</b>
		1.9 D Bus	51	07.87-02.94	1400[kg]	<b>KA 058</b>
		1.9 D Bus	51	07.87-02.94	1800[kg]	<b>KA 200</b>
<b>KA 079</b>		1.9 TD	60	04.92-02.94	1000*1400[kg]	<b>KA 058</b>
<b>KA 079</b>		1.9 TD	60	04.92-02.94	1800[kg]	<b>KA 200</b>
<b>KA 009</b>	CH. --> 604496	2.5 D Bus; 2.5 D TURBO Bus	54-70	10.85-02.94		
<b>KA 079</b>	CH. 604497 -->	2.5 D Bus; 2.5 D TURBO Bus	54-70	10.85-02.94		
		2.5 D Bus; 2.5 D TURBO Bus	54-70	10.85-02.94	CH. --> 278757 / 1000*1300[kg]	<b>KA 010</b>
		2.5 D Bus; 2.5 D TURBO Bus	54-70	10.85-02.94	CH. 278758 --> / 1000[kg]	<b>KA 058</b>
		2.5 D Bus; 2.5 D TURBO Bus	54-70	10.85-02.94	1400[kg]	<b>KA 058</b>
		2.5 D Bus; 2.5 D TURBO Bus	54-70	10.85-02.94	1800[kg]	<b>KA 200</b>
<b>KA 009</b>	CH. --> 604496	2.5 D 4x4 Bus; 2.5 D TURBO 4x4 Bus	54-70	01.87-02.94		
<b>KA 079</b>	CH. 604497 -->	2.5 D 4x4 Bus; 2.5 D TURBO 4x4 Bus	54-70	01.87-02.94		
<b>C35</b>						
<b>KB 011</b>		2.0 Bus; 2.0 Box Wagon	65	11.73-01.94		<b>KB 012</b>
<b>KB 011</b>		2.2 D Bus; 2.2 D Box Wagon; 2.5 D Bus; 2.5 D Box Wagon	45-51	11.73-01.94		<b>KB 012</b>
<b>DISPATCH (UGU)</b>						
<b>KF 113</b>		1.6; 1.6i; 2.0; 2.0i 16V	58-102	10.95-	ABS	<b>KV 236</b>
<b>KF 113</b>		1.6; 1.6i; 2.0; 2.0i 16V	58-102	10.95-		

	<b>i</b>	<b>ENGINE</b>	<b>POWER (kW)</b>	<b>YEAR</b>	<b>i</b>	
Fersa KIT FRONT						Fersa KIT REAR
<b>CITROËN</b>						
<b>DISPATCH (U6U)</b>						
<b>KF 113</b>		1.9 D; 1.9 TD; 2.0 HDi	51-80	10.95-	ABS	<b>KV 236</b>
<b>KF 113</b>		1.9 D; 1.9 TD; 2.0 HDi	51-80	10.95-		
<b>EVASION (22,U6)</b>						
<b>KF 113</b>		1.8; 2.0; 2.0 16V; 2.0 TURBO C.T.	73-108	06.94-07.02	ABS	<b>KV 236</b>
<b>KF 113</b>		1.9; 1.9 TD; 2.0 HDi; 2.0 TD; 2.1 TD	66-80	11.94-07.02	ABS	<b>KV 236</b>
<b>JUMPER (230)</b>						
<b>KA 079</b>	--> 11.01 / 1000*1400[kg]	2.0 Bus; 2.0 Box Wagon; 2.0 Platform	80	02.94-04.02	--> 11.01 / 1000*1400[kg]	<b>KA 013</b>
<b>KA 272</b>	--> 11.01 / 1800[kg]	2.0 Bus; 2.0 Box Wagon; 2.0 Platform	80	02.94-04.02	--> 11.01 / 1800[kg]	<b>KA 080</b>
<b>KA 079</b>	12.01 --> / 1000*1400[kg]	2.0 Bus; 2.0 Box Wagon; 2.0 Platform	80	02.94-04.02		
<b>KA 272</b>	12.01--> / 1800[kg]	2.0 Bus; 2.0 Box Wagon; 2.0 Platform	80	02.94-04.02		
<b>KA 079</b>	--> 11.01 / 1000*1400[kg]	2.0 4x4 Bus	80	08.96-04.02	--> 11.01 / 1000*1400[kg]	<b>KA 079</b>
<b>KA 272</b>	--> 11.01 / 1800[kg]	2.0 4x4 Bus	80	08.96-04.02		
<b>KA 079</b>	12.01 --> / 1000*1400[kg]	2.0 4x4 Bus	80	08.96-04.02		
<b>KA 272</b>	12.01--> / 1800[kg]	2.0 4x4 Bus	80	08.96-04.02		
<b>KA 079</b>	--> 11.01 / 1000*1400[kg]	1.9 D Bus; 1.9 D Box Wagon; 1.9 TD Bus; 1.9 TD Box Wagon; 1.9 TD Platform	50-68	02.94-04.02	--> 11.01 / 1000*1400[kg]	<b>KA 013</b>
<b>KA 272</b>	--> 11.01 / 1800[kg]	1.9 D Bus; 1.9 D Box Wagon; 1.9 TD Bus; 1.9 TD Box Wagon; 1.9 TD Platform	50-68	02.94-04.02	--> 11.01 / 1800[kg]	<b>KA 080</b>
<b>KA 079</b>	12.01 --> / 1000*1400[kg]	1.9 D Bus; 1.9 D Box Wagon; 1.9 TD Bus; 1.9 TD Box Wagon; 1.9 TD Platform	50-68	02.94-04.02		
<b>KA 272</b>	12.01--> / 1800[kg]	1.9 D Bus; 1.9 D Box Wagon; 1.9 TD Bus; 1.9 TD Box Wagon; 1.9 TD Platform	50-68	02.94-04.02		
<b>KA 079</b>	--> 11.01 / 1000*1400[kg]	1.9 TD 4x4 Bus	68	08.96-04.02	--> 11.01 / 1000*1400[kg]	<b>KA 079</b>
<b>KA 272</b>	--> 11.01 / 1800[kg]	1.9 TD 4x4 Bus	68	08.96-04.02		
<b>KA 079</b>	12.01 --> / 1000*1400[kg]	1.9 TD 4x4 Bus	68	08.96-04.02		
<b>KA 272</b>	12.01--> / 1800[kg]	1.9 TD 4x4 Bus	68	08.96-04.02		
<b>KA 079</b>	1000*1400[kg]	2.0 HDi Box Wagon	62	11.01-04.02		
<b>KA 272</b>	1800[kg]	2.0 HDi Box Wagon	62	11.01-04.02		
<b>KA 079</b>	--> 11.01 / 1000*1400[kg]	2.5 D Bus; 2.5 D Box Wagon; 2.5 D Platform; 2.5 TD Bus; 2.5 TD Box Wagon; 2.5 TD Platform	63-76	03.94-04.02	--> 11.01 / 1000*1400[kg]	<b>KA 013</b>
<b>KA 272</b>	--> 11.01 / 1800[kg]	2.5 D Bus; 2.5 D Box Wagon; 2.5 D Platform; 2.5 TD Bus; 2.5 TD Box Wagon; 2.5 TD Platform	63-76	03.94-04.02	--> 11.01 / 1800[kg]	<b>KA 080</b>
<b>KA 079</b>	12.01 --> / 1000*1400[kg]	2.5 D Bus; 2.5 D Box Wagon; 2.5 D Platform; 2.5 TD Bus; 2.5 TD Box Wagon; 2.5 TD Platform	63-76	03.94-04.02		
<b>KA 272</b>	12.01--> / 1800[kg]	2.5 D Bus; 2.5 D Box Wagon; 2.5 D Platform; 2.5 TD Bus; 2.5 TD Box Wagon; 2.5 TD Platform	63-76	03.94-04.02		
<b>KA 079</b>	--> 11.01 / 1000*1400[kg]	2.5 D 4x4 Bus; 2.5 D 4x4 Box Wagon; 2.5 D 4x4 Platform; 2.5 TD 4x4 Bus	63-76	08.96-04.02	--> 11.01 / 1000*1400[kg]	<b>KA 079</b>
<b>KA 272</b>	--> 11.01 / 1800[kg]	2.5 D 4x4 Bus; 2.5 D 4x4 Box Wagon; 2.5 D 4x4 Platform; 2.5 TD 4x4 Bus	63-76	08.96-04.02		
<b>KA 079</b>	12.01 --> / 1000*1400[kg]	2.5 D 4x4 Bus; 2.5 D 4x4 Box Wagon; 2.5 D 4x4 Platform; 2.5 TD 4x4 Bus	63-76	08.96-04.02		
<b>KA 272</b>	12.01--> / 1800[kg]	2.5 D 4x4 Bus; 2.5 D 4x4 Box Wagon; 2.5 D 4x4 Platform; 2.5 TD 4x4 Bus	63-76	08.96-04.02		
<b>KA 079</b>	1000*1400[kg]	2.5 TDi Bus; 2.5 TDi Box Wagon	79	12.96-11.00	1000*1400[kg]	<b>KA 013</b>
<b>KA 272</b>	1800[kg]	2.5 TDi Bus; 2.5 TDi Box Wagon	79	12.96-11.00	1800[kg]	<b>KA 080</b>
<b>KA 079</b>	--> 11.01 / 1000*1400[kg]	2.5 TDi Platform	79	12.96-04.02	--> 11.01 / 1000*1400[kg]	<b>KA 013</b>
<b>KA 272</b>	--> 11.01 / 1800[kg]	2.5 TDi Platform	79	12.96-04.02	--> 11.01 / 1800[kg]	<b>KA 080</b>
<b>KA 079</b>	12.01 --> / 1000*1400[kg]	2.5 TDi Platform	79	12.96-04.02		
<b>KA 272</b>	12.01--> / 1800[kg]	2.5 TDi Platform	79	12.96-04.02		
<b>KA 079</b>	1000*1400[kg]	2.5 TDi 4x4 Bus; 2.5 TDi 4x4 Box Wagon	79	12.96-11.00	1000*1400[kg]	<b>KA 079</b>
<b>KA 272</b>	1800[kg]	2.5 TDi 4x4 Bus; 2.5 TDi 4x4 Box Wagon	79	12.96-11.00		
<b>KA 079</b>	--> 11.01 / 1000*1400[kg]	2.5 TDi 4x4 Platform	79	03.00-04.02	--> 11.01 / 1000*1400[kg]	<b>KA 079</b>
<b>KA 272</b>	--> 11.01 / 1800[kg]	2.5 TDi 4x4 Platform	79	03.00-04.02		

	<b>i</b>	<b>ENGINE</b>	<b>POWER (kW)</b>	<b>YEAR</b>	<b>i</b>	
Fersa KIT FRONT						Fersa KIT REAR
<b>CITROËN</b>						
<b>JUMPER (230)</b>						
<b>KA 079</b>	12.01 --> / 1000*1400[kg]	2.5 TDi 4x4 Platform	79	03.00-04.02		
<b>KA 272</b>	12.01--> / 1800[kg]	2.5 TDi 4x4 Platform	79	03.00-04.02		
<b>KA 079</b>	--> 11.01 / 1000*1400[kg]	2.8 HDi Bus; 2.8 HDi Box Wagon; 2.8 HDi Platform	94	09.00-04.02	--> 11.01 / 1000*1400[kg]	<b>KA 013</b>
<b>KA 272</b>	--> 11.01 / 1800[kg]	2.8 HDi Bus; 2.8 HDi Box Wagon; 2.8 HDi Platform	94	09.00-04.02	--> 11.01 / 1800[kg]	<b>KA 080</b>
<b>KA 079</b>	12.01 --> / 1000*1400[kg]	2.8 HDi Bus; 2.8 HDi Box Wagon; 2.8 HDi Platform	94	09.00-04.02		
<b>KA 272</b>	12.01--> / 1800[kg]	2.8 HDi Bus; 2.8 HDi Box Wagon; 2.8 HDi Platform	94	09.00-04.02		
<b>KA 079</b>	--> 11.01 / 1000*1400[kg]	2.8 HDi 4x4 Bus; 2.8 HDi 4x4 Box Wagon	94	09.00-04.02	--> 11.01 / 1000*1400[kg]	<b>KA 079</b>
<b>KA 272</b>	--> 11.01 / 1800[kg]	2.8 HDi 4x4 Bus; 2.8 HDi 4x4 Box Wagon	94	09.00-04.02		
<b>KA 079</b>	12.01 --> / 1000*1400[kg]	2.8 HDi 4x4 Bus; 2.8 HDi 4x4 Box Wagon	94	09.00-04.02		
<b>KA 272</b>	12.01--> / 1800[kg]	2.8 HDi 4x4 Bus; 2.8 HDi 4x4 Box Wagon	94	09.00-04.02		
<b>JUMPER (244)</b>						
<b>KA 079</b>	-->05.04 / 1100*1500[kg]	2.0 Bus; 2.0 Box Wagon; 2.0 bivalent Bus; 2.0 bivalent Box Wagon	81	04.02-		
<b>KA 272</b>	--> 05.04 / 1800[kg]	2.0 Bus; 2.0 Box Wagon; 2.0 bivalent Bus; 2.0 bivalent Box Wagon	81	04.02-		
<b>KA 079</b>	-->05.04 / 1100*1500[kg]	2.0 HDi Bus; 2.0 HDi Box Wagon; 2.0 HDi Platform; 2.2 HDi Bus; 2.2 HDi Box Wagon; 2.2 HDi Platform; 2.8 HDi Bus; 2.8 HDi Box Wagon; 2.8 HDi Platform	62-107	04.02-		
<b>KA 272</b>	--> 05.04 / 1800[kg]	2.0 HDi Bus; 2.0 HDi Box Wagon; 2.0 HDi Platform; 2.2 HDi Bus; 2.2 HDi Box Wagon; 2.2 HDi Platform; 2.8 HDi Bus; 2.8 HDi Box Wagon; 2.8 HDi Platform	62-107	04.02-		
<b>KA 079</b>	-->05.04 / 1100*1500[kg]	2.8 HDi 4x4 Box Wagon	94	04.02-		
<b>KA 272</b>	--> 05.04 / 1800[kg]	2.8 HDi 4x4 Box Wagon	94	04.02-		
<b>KA 079</b>	-->05.04 / 1100*1500[kg]	2.8 HDi Platform	107	05.04-		
<b>KA 272</b>	--> 05.04 / 1800[kg]	2.8 HDi Platform	107	05.04-		
<b>JUMPY</b>						
<b>KF 113</b>		1.6; 1.6i; 2.0; 2.0i 16V	58-102	10.95-	ABS	<b>KV 236</b>
<b>KF 113</b>		1.9 D; 1.9 TD; 2.0 HDi	51-80	10.95-	ABS	<b>KV 236</b>
<b>LNA</b>						
		0.6	25	07.82-04.85		<b>KA 073</b>
		0.6	26	11.78-07.82	08.80 -->	<b>KA 073</b>
		1.0; 1.1	33-37	07.82-10.86		<b>KA 073</b>
<b>RELAY (230)</b>						
<b>KA 079</b>	--> 11.01 / 1000*1400[kg]	2.0 Bus; 2.0 Box Wagon; 2.0 Platform	80	02.94-04.02	--> 11.01 / 1000*1400[kg]	<b>KA 013</b>
<b>KA 272</b>	--> 11.01 / 1800[kg]	2.0 Bus; 2.0 Box Wagon; 2.0 Platform	80	02.94-04.02	--> 11.01 / 1800[kg]	<b>KA 080</b>
<b>KA 079</b>	12.01 --> / 1000*1400[kg]	2.0 Bus; 2.0 Box Wagon; 2.0 Platform	80	02.94-04.02		
<b>KA 272</b>	12.01--> / 1800[kg]	2.0 Bus; 2.0 Box Wagon; 2.0 Platform	80	02.94-04.02		
<b>KA 079</b>	--> 11.01 / 1000*1400[kg]	2.0 4x4 Bus	80	08.96-04.02	--> 11.01 / 1000*1400[kg]	<b>KA 079</b>
<b>KA 272</b>	--> 11.01 / 1800[kg]	2.0 4x4 Bus	80	08.96-04.02		
<b>KA 079</b>	12.01 --> / 1000*1400[kg]	2.0 4x4 Bus	80	08.96-04.02		
<b>KA 272</b>	12.01--> / 1800[kg]	2.0 4x4 Bus	80	08.96-04.02		
<b>KA 079</b>	--> 11.01 / 1000*1400[kg]	1.9 D Bus; 1.9 D Box Wagon; 1.9 TD Bus; 1.9 TD Box Wagon; 1.9 TD Platform	50-68	02.94-04.02	--> 11.01 / 1000*1400[kg]	<b>KA 013</b>
<b>KA 272</b>	--> 11.01 / 1800[kg]	1.9 D Bus; 1.9 D Box Wagon; 1.9 TD Bus; 1.9 TD Box Wagon; 1.9 TD Platform	50-68	02.94-04.02	--> 11.01 / 1800[kg]	<b>KA 080</b>
<b>KA 079</b>	12.01 --> / 1000*1400[kg]	1.9 D Bus; 1.9 D Box Wagon; 1.9 TD Bus; 1.9 TD Box Wagon; 1.9 TD Platform	50-68	02.94-04.02		
<b>KA 272</b>	12.01--> / 1800[kg]	1.9 D Bus; 1.9 D Box Wagon; 1.9 TD Bus; 1.9 TD Box Wagon; 1.9 TD Platform	50-68	02.94-04.02		
<b>KA 079</b>	--> 11.01 / 1000*1400[kg]	1.9 TD 4x4 Bus	68	08.96-04.02	--> 11.01 / 1000*1400[kg]	<b>KA 079</b>
<b>KA 272</b>	--> 11.01 / 1800[kg]	1.9 TD 4x4 Bus	68	08.96-04.02		
<b>KA 079</b>	12.01 --> / 1000*1400[kg]	1.9 TD 4x4 Bus	68	08.96-04.02		
<b>KA 272</b>	12.01--> / 1800[kg]	1.9 TD 4x4 Bus	68	08.96-04.02		



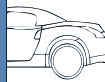

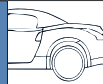
	<b>i</b>	<b>ENGINE</b>	<b>POWER (kW)</b>	<b>YEAR</b>	<b>i</b>	
Fersa KIT FRONT						Fersa KIT REAR
<b>CITROËN</b>						
<b>RELAY (230)</b>						
<b>KA 079</b>	1000*1400[kg]	2.0 HDi Box Wagon	62	11.01-04.02		
<b>KA 272</b>	1800[kg]	2.0 HDi Box Wagon	62	11.01-04.02		
<b>KA 079</b>	--> 11.01 / 1000*1400[kg]	2.5 D Bus; 2.5 D Box Wagon; 2.5 D Platform; 2.5 TD Bus; 2.5 TD Box Wagon; 2.5 TD Platform	63-76	03.94-04.02	--> 11.01 / 1000*1400[kg]	<b>KA 013</b>
<b>KA 272</b>	--> 11.01 / 1800[kg]	2.5 D Bus; 2.5 D Box Wagon; 2.5 D Platform; 2.5 TD Bus; 2.5 TD Box Wagon; 2.5 TD Platform	63-76	03.94-04.02	--> 11.01 / 1800[kg]	<b>KA 080</b>
<b>KA 079</b>	12.01 --> / 1000*1400[kg]	2.5 D Bus; 2.5 D Box Wagon; 2.5 D Platform; 2.5 TD Bus; 2.5 TD Box Wagon; 2.5 TD Platform	63-76	03.94-04.02		
<b>KA 272</b>	12.01--> / 1800[kg]	2.5 D Bus; 2.5 D Box Wagon; 2.5 D Platform; 2.5 TD Bus; 2.5 TD Box Wagon; 2.5 TD Platform	63-76	03.94-04.02		
<b>KA 079</b>	--> 11.01 / 1000*1400[kg]	2.5 D 4x4 Bus; 2.5 D 4x4 Box Wagon; 2.5 D 4x4 Platform; 2.5 TD 4x4 Bus	63-76	08.96-04.02	--> 11.01 / 1000*1400[kg]	<b>KA 079</b>
<b>KA 272</b>	--> 11.01 / 1800[kg]	2.5 D 4x4 Bus; 2.5 D 4x4 Box Wagon; 2.5 D 4x4 Platform; 2.5 TD 4x4 Bus	63-76	08.96-04.02		
<b>KA 079</b>	12.01 --> / 1000*1400[kg]	2.5 D 4x4 Bus; 2.5 D 4x4 Box Wagon; 2.5 D 4x4 Platform; 2.5 TD 4x4 Bus	63-76	08.96-04.02		
<b>KA 272</b>	12.01--> / 1800[kg]	2.5 D 4x4 Bus; 2.5 D 4x4 Box Wagon; 2.5 D 4x4 Platform; 2.5 TD 4x4 Bus	63-76	08.96-04.02		
<b>KA 079</b>	1000*1400[kg]	2.5 TDi Bus; 2.5 TDi Box Wagon	79	12.96-11.00	1000*1400[kg]	<b>KA 013</b>
<b>KA 272</b>	1800[kg]	2.5 TDi Bus; 2.5 TDi Box Wagon	79	12.96-11.00	1800[kg]	<b>KA 080</b>
<b>KA 079</b>	--> 11.01 / 1000*1400[kg]	2.5 TDi Platform	79	12.96-04.02	--> 11.01 / 1000*1400[kg]	<b>KA 013</b>
<b>KA 272</b>	--> 11.01 / 1800[kg]	2.5 TDi Platform	79	12.96-04.02	--> 11.01 / 1800[kg]	<b>KA 080</b>
<b>KA 079</b>	12.01 --> / 1000*1400[kg]	2.5 TDi Platform	79	12.96-04.02		
<b>KA 272</b>	12.01--> / 1800[kg]	2.5 TDi Platform	79	12.96-04.02		
<b>KA 079</b>	1000*1400[kg]	2.5 TDi 4x4 Bus; 2.5 TDi 4x4 Box Wagon	79	12.96-11.00	1000*1400[kg]	<b>KA 079</b>
<b>KA 272</b>	1800[kg]	2.5 TDi 4x4 Bus; 2.5 TDi 4x4 Box Wagon	79	12.96-11.00		
<b>KA 079</b>	--> 11.01 / 1000*1400[kg]	2.5 TDi 4x4 Platform	79	03.00-04.02	--> 11.01 / 1000*1400[kg]	<b>KA 079</b>
<b>KA 272</b>	--> 11.01 / 1800[kg]	2.5 TDi 4x4 Platform	79	03.00-04.02		
<b>KA 079</b>	12.01 --> / 1000*1400[kg]	2.5 TDi 4x4 Platform	79	03.00-04.02		
<b>KA 272</b>	12.01--> / 1800[kg]	2.5 TDi 4x4 Platform	79	03.00-04.02		
<b>KA 079</b>	--> 11.01 / 1000*1400[kg]	2.8 HDi Bus; 2.8 HDi Box Wagon; 2.8 HDi Platform	94	09.00-04.02	--> 11.01 / 1000*1400[kg]	<b>KA 013</b>
<b>KA 272</b>	--> 11.01 / 1800[kg]	2.8 HDi Bus; 2.8 HDi Box Wagon; 2.8 HDi Platform	94	09.00-04.02	--> 11.01 / 1800[kg]	<b>KA 080</b>
<b>KA 079</b>	12.01 --> / 1000*1400[kg]	2.8 HDi Bus; 2.8 HDi Box Wagon; 2.8 HDi Platform	94	09.00-04.02		
<b>KA 272</b>	12.01--> / 1800[kg]	2.8 HDi Bus; 2.8 HDi Box Wagon; 2.8 HDi Platform	94	09.00-04.02		
<b>KA 079</b>	--> 11.01 / 1000*1400[kg]	2.8 HDi 4x4 Bus; 2.8 HDi 4x4 Box Wagon	94	09.00-04.02	--> 11.01 / 1000*1400[kg]	<b>KA 079</b>
<b>KA 272</b>	--> 11.01 / 1800[kg]	2.8 HDi 4x4 Bus; 2.8 HDi 4x4 Box Wagon	94	09.00-04.02		
<b>KA 079</b>	12.01 --> / 1000*1400[kg]	2.8 HDi 4x4 Bus; 2.8 HDi 4x4 Box Wagon	94	09.00-04.02		
<b>KA 272</b>	12.01--> / 1800[kg]	2.8 HDi 4x4 Bus; 2.8 HDi 4x4 Box Wagon	94	09.00-04.02		
<b>RELAY (244)</b>						
<b>KA 079</b>	-->05.04 / 1100*1500[kg]	2.0 Bus; 2.0 Box Wagon; 2.0 bivalent Bus; 2.0 bivalent Box Wagon	81	04.02-		
<b>KA 272</b>	--> 05.04 / 1800[kg]	2.0 Bus; 2.0 Box Wagon; 2.0 bivalent Bus; 2.0 bivalent Box Wagon	81	04.02-		
<b>KA 079</b>	-->05.04 / 1100*1500[kg]	2.0 HDi Bus; 2.0 HDi Box Wagon; 2.0 HDi Platform; 2.2 HDi Bus; 2.2 HDi Box Wagon; 2.2 HDi Platform; 2.8 HDi Bus; 2.8 HDi Box Wagon;	62-107	04.02-		
<b>KA 272</b>	--> 05.04 / 1800[kg]	2.0 HDi Bus; 2.0 HDi Box Wagon; 2.0 HDi Platform; 2.2 HDi Bus; 2.2 HDi Box Wagon; 2.2 HDi Platform; 2.8 HDi Bus; 2.8 HDi Box Wagon;	62-107	04.02-		
<b>KA 079</b>	-->05.04 / 1100*1500[kg]	2.8 HDi 4x4 Box Wagon	94	04.02-		
<b>KA 272</b>	--> 05.04 / 1800[kg]	2.8 HDi 4x4 Box Wagon	94	04.02-		
<b>KA 079</b>	-->05.04 / 1100*1500[kg]	2.8 HDi Platform	107	05.04-		
<b>KA 272</b>	--> 05.04 / 1800[kg]	2.8 HDi Platform	107	05.04-		
<b>SAXO (S0,S1)</b>						
<b>KF 111</b>	--> 09.99	0.0 Electric	20	11.96-06.03		

	<b>i</b>	ENGINE	POWER (kW)	YEAR	<b>i</b>	
Fersa KIT FRONT						Fersa KIT REAR
<b>CITROËN</b>						
<b>SAXO (S0,S1)</b>						
<b>KF 142</b>	10.99 -->	0.0 Electric	20	11.96-06.03		
		0.0 Electric	20	11.96-06.03	--> 01.99	<b>KF 112</b>
		0.0 Electric	20	11.96-06.03	--> 01.99	<b>KB 008</b>
<b>KF 111</b>		1.0 X	33	05.96-11.98		<b>KF 112</b>
<b>KF 111</b>		1.0 X	33	05.96-11.98		<b>KB 008</b>
<b>KF 111</b>	--> 09.99	1.0 X; 1.1 X,SX; 1.4 SX; 1.6 VTL,VTR	37-65	05.96-09.03		
<b>KF 142</b>	10.99 -->	1.0 X; 1.1 X,SX; 1.4 SX; 1.6 VTL,VTR	37-65	05.96-09.03		
		1.0 X; 1.1 X,SX; 1.4 SX; 1.6 VTL,VTR	37-65	05.96-09.03	--> 01.99	<b>KF 112</b>
		1.0 X; 1.1 X,SX; 1.4 SX; 1.6 VTL,VTR	37-65	05.96-09.03	--> 01.99	<b>KB 008</b>
<b>KF 142</b>		1.6 VTS	72	09.00-09.03		<b>KB 008</b>
<b>KF 111</b>		1.6 VTR	80	05.96-07.99	--> 01.99	<b>KF 112</b>
<b>KF 111</b>		1.6 VTR	80	05.96-07.99	--> 01.99	<b>KB 008</b>
<b>KF 111</b>	--> 09.99	1.6 VTS	87	06.96-09.03		
<b>KF 142</b>	10.99 -->	1.6 VTS	87	06.96-09.03		
		1.6 VTS	87	06.96-09.03	--> 01.99	<b>KF 112</b>
		1.6 VTS	87	06.96-09.03	--> 01.99	<b>KB 008</b>
<b>KF 111</b>	--> 09.99	1.5 D	40-42	09.96-09.03		
<b>KF 142</b>	10.99 -->	1.5 D	40-42	09.96-09.03		
		1.5 D	40-42	09.96-09.03	02.99 --> / --> 09.99	<b>KF 112</b>
		1.5 D	40-42	09.96-09.03	02.99 --> / --> 09.99	<b>KB 008</b>
<b>KF 111</b>		1.0i	40-42	02.99-07.99		<b>KB 078</b>
<b>KF 145</b>		1.0i	40-42	10.99-		<b>KB 078</b>
<b>KF 145</b>	ABS	1.1i	40-42	02.99-09.99		<b>KB 078</b>
<b>KF 145</b>		1.1i	40-42	10.99-		<b>KB 078</b>
<b>KF 145</b>		1.0i, 1.1i Enterprise	40-42	02.99-		<b>KB 078</b>
<b>KF 145</b>		1.0i, 1.1i Enterprise c/Reinforced suspension	40-42	02.99-		<b>KB 078</b>
<b>KF 145</b>		1.4i	40-42	02.99-		<b>KB 078</b>
<b>KF 145</b>		1.5 D	40-42	02.99-		<b>KB 078</b>
<b>KF 145</b>	DRUM BRAKE	1.6i	40-42	02.99-		<b>KB 078</b>
<b>KF 145</b>	DISC BRAKE	1.6i	40-42	02.99-		<b>KB 078</b>
<b>KF 145</b>	DISC BRAKE	1.6i	40-42	02.99-		<b>KB 078</b>
<b>KF 145</b>		1.6i	40-42	02.99-		<b>KB 078</b>
<b>KF 145</b>		Electric	40-42	02.99-		<b>KB 078</b>
<b>SYNERGIE (22,U6)</b>						
<b>KF 113</b>		1.8; 2.0; 2.0 16V; 2.0 TURBO C.T.	73-108	06.94-07.02	ABS	<b>KV 236</b>
<b>KF 113</b>		1.9; 1.9 TD; 2.0 HDi; 2.0 TD; 2.1 TD	66-80	11.94-07.02	ABS	<b>KV 236</b>
<b>VISA</b>						
		0.6; 1.0; 11 E; 11 RE; 14; 14 GT; II Super X	24-58	09.78-03.91		<b>KA 073</b>
<b>KF 142</b>		16 GTI	76-83	01.85-03.91		<b>KB 008</b>
<b>KF 142</b>		17 D	44	04.84-03.91		<b>KB 008</b>
<b>XANTIA (X1)</b>						
<b>KF 143</b>		1.6i Hatchback	65	03.93-01.98		
		1.6i Hatchback	65	03.93-01.98	ABS / CH. --> 6778	<b>KV 144</b>
		1.6i Hatchback	65	03.93-01.98	ABS / CH. 6779 -->	<b>KV 114</b>
<b>KF 143</b>		1.8i Hatchback; 1.8i Estate Car	66	04.97-01.98		<b>KV 114</b>
<b>KF 143</b>		1.8i Hatchback	74	03.93-01.98	ABS / CH. --> 6778	<b>KV 144</b>
<b>KF 143</b>		1.8i Hatchback	74	03.93-01.98	ABS / CH. 6779 -->	<b>KV 114</b>
<b>KF 143</b>		1.8i Estate Car; 1.8i 16V Hatchback; 1.8i 16V Estate Car	74-81	06.95-01.98		<b>KV 114</b>
<b>KF 143</b>		2.0i Hatchback	89	03.93-01.98	ABS / CH. --> 6778	<b>KF 112</b>
<b>KF 143</b>		2.0i Hatchback	89	03.93-01.98	ABS / CH. 6779 -->	<b>KV 114</b>

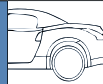
	<b>i</b>	<b>ENGINE</b>	<b>POWER (kW)</b>	<b>YEAR</b>	<b>i</b>	
Fersa KIT FRONT						Fersa KIT REAR
<b>CITROËN</b>						
<b>XANTIA (X1)</b>						
<b>KF 143</b>		2.0 TURBO Hatchback; 2.0 TURBO Estate Car; 2.0i Estate Car; 2.0i 16V Hatchback; 2.0i 16V Estate Car	89-108	06.95-01.98		<b>KV 114</b>
<b>KF 143</b>		2.0i 16V Hatchback	110-112	03.93-01.98	ABS / CH. --> 6778	<b>KV 144</b>
<b>KF 143</b>		2.0i 16V Hatchback	110-112	03.93-01.98	ABS / CH. 6779 -->	<b>KV 114</b>
<b>KF 143</b>		1.9 D Hatchback	50-51	06.94-01.98	ABS / CH. --> 6778	<b>KV 144</b>
<b>KF 143</b>		1.9 D Hatchback	50-51	06.94-01.98	ABS / CH. 6779 -->	<b>KV 114</b>
<b>KF 143</b>		1.9 D Hatchback; 1.9 D Estate Car; 1.9 TD Estate Car	55-66	06.95-01.98		<b>KV 114</b>
<b>KF 143</b>		1.9 TD Hatchback	66	10.94-01.98	ABS / CH. --> 6778	<b>KV 144</b>
<b>KF 143</b>		1.9 TD Hatchback	66	10.94-01.98	ABS / CH. 6779 -->	<b>KV 114</b>
<b>KF 143</b>		2.1 TD 12 Hatchback; 2.1 TD 12V Estate Car	80	06.95-01.98		<b>KV 114</b>
<b>KF 143</b>		1.8i Hatchback; 1.8i Estate Car; 1.8i 16V Hatchback; 1.8i 16V Estate Car; 2.0i Hatchback; 2.0i Estate Car; 2.0i 16V Hatchback; 2.0i 16V Estate Car	66-97	01.98-04.03		<b>KV 114</b>
<b>KF 143</b>		2.0 TURBO Hatchback	108	01.98-04.03		<b>KV 114</b>
<b>KF 143</b>		2.0 TURBO Estate Car; 3.0 V6 Hatchback; 3.0 V6 Estate Car	108-140	01.98-04.03		<b>KV 114</b>
<b>KF 143</b>		1.9 D Hatchback; 1.9 SD Estate Car; 1.9 TURBO D Hatchback; 1.9 TURBO D Estate Car; 2.0 HDi Hatchback; 2.0 HDi Estate Car; 2.0 HDI 90 Hatchback; 2.0 HDI 90 Estate Car; 2.1 TURBO D 12V Hatchback; 2.1 TURBO D 12V Estate Car	55-80	01.98-04.03		<b>KV 114</b>
<b>XM (Y4)</b>						
<b>KF 313</b>	05.97 --> / CH. 7478 -->	2.0 TURBO; 2.0i 16V; 3.0 V6	97-140	05.94-10.00		
<b>KF 313</b>	--> 04.97 / CH. --> 7478	3.0 V6	123	05.94-10.00		
<b>KF 313</b>	05.97 --> / CH. 7478 -->	3.0 V6 24V	147	05.94-10.00		
<b>KF 313</b>	05.97 --> / CH. 7478 -->	2.1 TD 12V	80	05.94-10.00		
<b>KF 313</b>	--> 04.97 / CH. --> 7478	2.1 TD 12V	80	05.94-10.00		
<b>KF 313</b>	05.97 --> / CH. 7478 -->	2.5 TD	95	05.94-10.00		
<b>XSARA</b>						
<b>KF 143</b>		1.4i Hatchback	55	04.97-03.05		
<b>KF 142</b>	ABS / --> 01.99	1.4i Hatchback	55	04.97-03.05		
<b>KF 145</b>	ABS / 02.99 -->	1.4i Hatchback	55	04.97-03.05		
		1.4i Hatchback	55	04.97-03.05	--> 09.98	<b>KB 008</b>
		1.4i Hatchback	55	04.97-03.05	10.98 -->	<b>KB 008</b>
<b>KF 143</b>		1.4i Estate Car	55	10.97-08.05		
<b>KF 142</b>	ABS / --> 01.99	1.4i Estate Car	55	10.97-08.05		
<b>KF 145</b>	ABS / 02.99 -->	1.4i Estate Car	55	10.97-08.05		
		1.4i Estate Car	55	10.97-08.05	--> 09.98 / DISC BRAKE	<b>KV 219</b>
		1.4i Estate Car	55	10.97-08.05	10.98 --> / DRUM BRAKE	<b>KV 305</b>
		1.4i Estate Car	55	10.97-08.05	10.98 -->	<b>KV 305</b>
<b>KF 143</b>		1.4i Coupe	55	03.98-03.05		
<b>KF 142</b>	ABS / --> 01.99	1.4i Coupe	55	03.98-03.05		
<b>KF 145</b>	ABS / 02.99 -->	1.4i Coupe	55	03.98-03.05		
		1.4i Coupe	55	03.98-03.05	--> 09.98	<b>KB 008</b>
		1.4i Coupe	55	03.98-03.05	10.98 -->	<b>KB 008</b>
<b>KF 143</b>		1.6i Hatchback	65	04.97-09.00		
<b>KF 142</b>	ABS / --> 01.99	1.6i Hatchback	65	04.97-09.00		
<b>KF 145</b>	ABS / 02.99 -->	1.6i Hatchback	65	04.97-09.00		
		1.6i Hatchback	65	04.97-09.00	--> 09.98	<b>KB 008</b>
		1.6i Hatchback	65	04.97-09.00	10.98 -->	<b>KB 008</b>
<b>KF 143</b>		1.6i Estate Car	65	10.97-09.00		
<b>KF 142</b>	ABS / --> 01.99	1.6i Estate Car	65	10.97-09.00		
<b>KF 145</b>	ABS / 02.99 -->	1.6i Estate Car	65	10.97-09.00		
		1.6i Estate Car	65	10.97-09.00	--> 09.98 / DISC BRAKE	<b>KV 219</b>

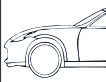
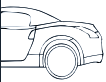
	<b>i</b>	ENGINE	POWER (kW)	YEAR	<b>i</b>	
Fersa KIT FRONT						Fersa KIT REAR
<b>CITROËN</b>						
<b>XSARA</b>						
		1.6i Estate Car	65	10.97-09.00	10.98 --> / DRUM BRAKE	<b>KV 305</b>
<b>KF 143</b>		1.6i Coupe	65	02.98-09.00		
<b>KF 142</b>		1.6i Coupe	65	02.98-09.00		
		1.6i Coupe	65	02.98-09.00	--> 09.98	<b>KB 008</b>
<b>KF 143</b>		1.6 16V Hatchback	80	09.00-03.05		<b>KB 008</b>
<b>KF 145</b>		1.6 16V Hatchback	80	09.00-03.05		<b>KB 008</b>
<b>KF 143</b>		1.6 16V Estate Car	80	09.00-08.05		<b>KV 305</b>
<b>KF 145</b>		1.6 16V Estate Car	80	09.00-08.05	DRUM BRAKE	<b>KV 305</b>
<b>KF 143</b>		1.6 16V Coupe	80	09.00-03.05		<b>KB 008</b>
<b>KF 145</b>		1.6 16V Coupe	80	09.00-03.05		<b>KB 008</b>
<b>KF 143</b>		1.8i Hatchback	66	04.97-09.00	--> 09.98 / DISC BRAKE	<b>KV 219</b>
<b>KF 143</b>		1.8i Hatchback	66	04.97-09.00	--> 09.98 / DISC BRAKE	<b>KB 008</b>
<b>KF 143</b>		1.8i Hatchback	66	04.97-09.00	10.98 -->	<b>KB 008</b>
<b>KF 143</b>		1.8i Estate Car	66	10.97-09.00	--> 09.98 / DISC BRAKE	<b>KV 219</b>
<b>KF 143</b>		1.8i Estate Car	66	10.97-09.00	10.98 --> / DRUM BRAKE	<b>KV 305</b>
<b>KF 143</b>		1.8i Coupe	66	02.98-09.00	ABS / --> 08.98	<b>KV 219</b>
<b>KF 143</b>		1.8i Coupe	66	02.98-09.00	--> 09.98	<b>KV 305</b>
<b>KF 143</b>		1.8i Coupe	66	02.98-09.00	ABS / --> 08.98	<b>KV 275</b>
<b>KF 143</b>		1.8i Hatchback	74	04.97-09.00	--> 09.98 / DISC BRAKE	<b>KV 219</b>
<b>KF 143</b>		1.8i Hatchback	74	04.97-09.00	--> 09.98 / DISC BRAKE	<b>KB 008</b>
<b>KF 143</b>		1.8i Hatchback	74	04.97-09.00	10.98 -->	<b>KB 008</b>
<b>KF 143</b>		1.8i Estate Car	74	10.97-09.00	--> 09.98 / DISC BRAKE	<b>KV 219</b>
<b>KF 143</b>		1.8i Estate Car	74	10.97-09.00	10.98 --> / DRUM BRAKE	<b>KV 305</b>
<b>KF 143</b>		1.8i Estate Car	74	10.97-09.00	10.98 -->	<b>KV 305</b>
<b>KF 143</b>		1.8i Coupe	74	02.98-09.00	ABS / --> 09.98	<b>KV 219</b>
<b>KF 143</b>		1.8i Coupe	74	02.98-09.00	--> 09.98	<b>KV 305</b>
<b>KF 143</b>		1.8i Coupe	74	02.98-09.00	--> 09.98	<b>KB 008</b>
<b>KF 143</b>		1.8i 16V Hatchback	81	04.97-09.00	--> 09.98 / DISC BRAKE	<b>KV 219</b>
<b>KF 143</b>		1.8i 16V Hatchback	81	04.97-09.00	--> 09.98 / DISC BRAKE	<b>KB 008</b>
<b>KF 143</b>		1.8i 16V Hatchback	81	04.97-09.00	10.98 -->	<b>KB 008</b>
<b>KF 143</b>		1.8i 16V Estate Car	81	10.97-09.00	--> 09.98 / DISC BRAKE	<b>KV 219</b>
<b>KF 143</b>		1.8i 16V Estate Car	81	10.97-09.00	10.98 --> / DRUM BRAKE	<b>KV 305</b>
<b>KF 143</b>		1.8i 16V Coupe	81	02.98-09.00	ABS / --> 08.98	<b>KV 219</b>
<b>KF 143</b>		1.8i 16V Coupe	81	02.98-09.00	ABS / 09.98 -->	<b>KV 305</b>
<b>KF 143</b>		1.8i 16V Coupe	81	02.98-09.00	ABS / --> 08.98	<b>KV 275</b>
<b>KF 143</b>		1.8i 16V Coupe	81	10.98-		<b>KB 078</b>
<b>KF 143</b>		1.8i 16V Coupe	81	10.98-		<b>KB 078</b>
<b>KF 143</b>		1.8i 16V Coupe	81	10.98-		<b>KB 078</b>
<b>KF 143</b>		1.8i 16V Coupe	81	10.98-		<b>KB 078</b>
<b>KF 143</b>		2.0 16V Hatchback	100	09.00-03.05		<b>KB 008</b>
<b>KF 143</b>		2.0 16V Estate Car	100	09.00-08.05		<b>KV 305</b>
<b>KF 143</b>		2.0 16V Coupe	100	09.00-03.05		<b>KB 008</b>
<b>KF 143</b>		2.0 16V Hatchback	97	07.98-09.00	--> 09.98 / DISC BRAKE	<b>KV 219</b>
<b>KF 143</b>		2.0 16V Hatchback	97	07.98-09.00	--> 09.98 / DISC BRAKE	<b>KB 008</b>
<b>KF 143</b>		2.0 16V Hatchback	97	07.98-09.00	10.98 -->	<b>KB 008</b>
<b>KF 143</b>		2.0 16V Estate Car	97	07.98-09.00	--> 09.98 / DISC BRAKE	<b>KV 219</b>
<b>KF 143</b>		2.0 16V Estate Car	97	07.98-09.00	10.98 --> / DRUM BRAKE	<b>KV 305</b>
		2.0 16V Hatchback	120	04.97-09.00	--> 09.98 / DISC BRAKE	<b>KV 219</b>
<b>KF 143</b>		2.0 16V Hatchback	120	04.97-09.00	--> 09.98 / DISC BRAKE	<b>KB 008</b>
<b>KF 143</b>		2.0 16V Hatchback	120	04.97-09.00	10.98 -->	<b>KB 008</b>

 Fersa KIT FRONT	<b>i</b>	ENGINE	POWER (kW)	YEAR	<b>i</b>	Fersa KIT REAR 
<b>CITROËN</b>						
<b>XSARA</b>						
KF 143		2.0i 16V Coupe	120	02.98-03.05	ABS / --> 08.98	<b>KV 219</b>
KF 143		2.0i 16V Coupe	120	02.98-03.05	ABS / --> 08.98	<b>KV 275</b>
KF 143		2.0i 16V Coupe	120	02.98-03.05	09.00 -->	<b>KB 008</b>
KF 142	ABS / --> 01.99	1.5 D Hatchback	42	04.97-09.00		
KF 145	ABS / 02.99 -->	1.5 D Hatchback	42	04.97-09.00		
KF 143		1.5 D Hatchback	42	04.97-09.00	--> 09.98 / DISC BRAKE	<b>KV 219</b>
KF 143		1.5 D Hatchback	42	04.97-09.00	--> 09.98	<b>KB 008</b>
KF 143		1.5 D Hatchback	42	04.97-09.00	10.98 -->	<b>KB 008</b>
KF 143		1.5 D Estate Car	42	10.97-09.00		
KF 142	ABS / --> 01.99	1.5 D Estate Car	42	10.97-09.00		
KF 145	ABS / 02.99 -->	1.5 D Estate Car	42	10.97-09.00		
KF 143		1.5 D Estate Car	42	10.97-09.00	--> 09.98 / DISC BRAKE	<b>KV 219</b>
KF 143		1.5 D Estate Car	42	10.97-09.00	10.98 --> / DRUM BRAKE	<b>KV 305</b>
KF 142	ABS / --> 01.99	1.8 D Hatchback; 1.8 TD Hatchback	43-66	04.97-09.00		
KF 145	ABS / 02.99 -->	1.8 D Hatchback; 1.8 TD Hatchback	43-66	04.97-09.00		
KF 143		1.8 D Hatchback; 1.8 TD Hatchback	43-66	04.97-09.00	--> 09.98 / DISC BRAKE	<b>KV 219</b>
KF 143		1.8 D Hatchback; 1.8 TD Hatchback	43-66	04.97-09.00	--> 09.98 / DISC BRAKE	<b>KB 008</b>
KF 143		1.8 D Estate Car	43	10.97-09.00	--> 09.98 / DISC BRAKE	<b>KV 219</b>
KF 143		1.8 D Estate Car	43	10.97-09.00	10.98 --> / DRUM BRAKE	<b>KV 305</b>
KF 143		1.9 D Hatchback	51	07.98-03.05	--> 09.98 / DISC BRAKE	<b>KB 008</b>
KF 143		1.9 D Hatchback	51	07.98-03.05	10.98 -->	<b>KB 008</b>
KF 143		1.9 D Estate Car	51	07.98-08.05	--> 09.98 / DISC BRAKE	<b>KB 008</b>
KF 143		1.9 D Estate Car	51	07.98-08.05	10.98 --> / DRUM BRAKE	<b>KB 008</b>
KF 143		1.9 D Coupe	51	02.99-03.05		<b>KB 008</b>
KF 143		1.9 D Hatchback	50	04.97-09.00	--> 09.98 / DISC BRAKE	<b>KV 219</b>
KF 143		1.9 D Hatchback	50	04.97-09.00	--> 09.98 / DISC BRAKE	<b>KB 008</b>
KF 143		1.9 D Hatchback	50	04.97-09.00	10.98 -->	<b>KB 008</b>
KF 143		1.9 D Estate Car	50	10.97-09.00	--> 09.98 / DISC BRAKE	<b>KV 219</b>
KF 143		1.9 D Estate Car	50	10.97-09.00	10.98 --> / DRUM BRAKE	<b>KV 305</b>
KF 143		1.9 D Coupe	50	02.98-09.00	--> 09.98	<b>KB 008</b>
KF 143		1.9 D Coupe	50	02.98-09.00	10.98 -->	<b>KB 008</b>
KF 143		1.9 D Hatchback	55	01.98-09.00	--> 09.98 / DISC BRAKE	<b>KV 219</b>
KF 143		1.9 D Hatchback	55	01.98-09.00	--> 09.98 / DISC BRAKE	<b>KB 008</b>
KF 143		1.9 D Hatchback	55	01.98-09.00	10.98 -->	<b>KB 008</b>
KF 143		1.9 D Estate Car	55	01.98-09.00	--> 09.98 / DISC BRAKE	<b>KV 219</b>
KF 143		1.9 D Estate Car	55	01.98-09.00	10.98 --> / DRUM BRAKE	<b>KV 305</b>
KF 143		1.9 TD Hatchback	66	04.97-09.00	--> 09.98 / DISC BRAKE	<b>KV 219</b>
KF 143		1.9 TD Hatchback	66	04.97-09.00	--> 09.98 / DISC BRAKE	<b>KB 008</b>
KF 143		1.9 TD Hatchback	66	04.97-09.00	10.98 -->	<b>KB 008</b>
KF 143		1.9 TD Estate Car	66	10.97-09.00	--> 09.98 / DISC BRAKE	<b>KV 219</b>
KF 143		1.9 TD Estate Car	66	10.97-09.00	10.98 --> / DRUM BRAKE	<b>KV 305</b>
KF 143		1.9 TD Coupe	66	02.98-09.00	ABS / --> 08.98	<b>KV 219</b>
KF 143		1.9 TD Coupe	66	02.98-09.00	ABS / --> 08.98	<b>KV 275</b>
KF 143		2.0 HDI 90 Hatchback	66	02.99-03.05		<b>KV 219</b>
KF 143		2.0 HDI 90 Estate Car	66	02.99-08.05		<b>KB 008</b>
KF 143		2.0 HDI 90 Coupe	66	02.99-03.05	ABS / --> 08.00	<b>KV 305</b>
KF 143		2.0 HDI 90 Coupe	66	02.99-03.05	09.00 -->	<b>KB 008</b>
KF 143		2.0 HDi 109 Hatchback	80	05.01-03.05		
KF 143		2.0 HDi 109 Coupe	80	05.01-03.05		<b>KB 008</b>

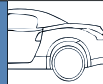
	<b>i</b>	ENGINE	POWER (kW)	YEAR	<b>i</b>	
Fersa KIT FRONT						Fersa KIT REAR
<b>CITROËN</b>						
<b>XSARA PICASSO</b>						
<b>KF 143</b>		1.6; 1.6 Saloon Car	65-70	06.00-	<b>ABS</b>	<b>KV 114</b>
<b>KF 143</b>		1.6 Chrono	74	04.01-10.04	<b>ABS</b>	<b>KV 114</b>
<b>KF 143</b>		1.6 16V Saloon Car	80	09.05-	<b>ABS</b>	<b>KV 114</b>
<b>KF 143</b>		1.8 16V Saloon Car; 1.8 SX; 2.0 16V Saloon Car	76-100	02.00-	<b>ABS</b>	<b>KV 114</b>
<b>KF 143</b>		1.6 HDi Saloon Car	66	09.05-	<b>ABS</b>	<b>KV 114</b>
<b>KF 143</b>		1.6 HDi Saloon Car; 2.0 HDi Saloon Car	66-80	12.99-	<b>ABS</b>	<b>KV 114</b>
<b>ZX</b>						
<b>KF 143</b>		1.1 Hatchback	44	03.91-06.97		
<b>KF 142</b>		1.1 Hatchback	44	03.91-06.97	DISC BRAKE	<b>KV 219</b>
<b>KF 142</b>		1.1 Hatchback	44	03.91-06.97		<b>KB 008</b>
<b>KF 142</b>		1.4i Hatchback	55	03.91-06.97		<b>KB 008</b>
<b>KF 143</b>		1.4i Hatchback	55	03.91-06.97		
<b>KF 142</b>		1.4i Hatchback	55	03.91-06.97	DISC BRAKE	<b>KV 219</b>
<b>KF 142</b>		1.4i Hatchback	55	03.91-06.97		<b>KB 008</b>
<b>KF 143</b>		1.4i Estate Car	55	10.93-10.97		
<b>KF 142</b>		1.4i Estate Car	55	10.93-10.97		
<b>KF 143</b>		1.6i Hatchback	65	03.91-06.97		<b>KB 008</b>
<b>KF 143</b>		1.6i Estate Car	65	10.93-10.97		
<b>KF 143</b>		1.8i Hatchback	74	07.92-06.97	DISC BRAKE	<b>KV 219</b>
<b>KF 143</b>		1.8i Hatchback	74	07.92-06.97		<b>KB 008</b>
<b>KF 143</b>		1.8i Estate Car	74	10.93-10.97		
<b>KF 143</b>		1.8i 16V Hatchback	81	01.96-06.97		
<b>KF 142</b>		1.8i 16V Hatchback	81	01.96-06.97	DISC BRAKE	<b>KV 219</b>
<b>KF 142</b>		1.8i 16V Hatchback	81	01.96-06.97		<b>KB 008</b>
<b>KF 142</b>		1.8i 16V Estate Car	81	01.96-02.98		
<b>KF 142</b>		1.8i 16V Estate Car	81	01.96-02.98		
		1.8i 16V Estate Car	81	01.96-02.98		<b>KV 305</b>
<b>KF 143</b>		1.9i Hatchback; 2.0i Hatchback	88-89	03.91-06.97	DISC BRAKE	<b>KV 219</b>
<b>KF 143</b>		1.9i Hatchback; 2.0i Hatchback	88-89	03.91-06.97		<b>KB 008</b>
<b>KF 143</b>		2.0i 16V Hatchback	110-120	07.92-06.97	DISC BRAKE	<b>KV 219</b>
<b>KF 143</b>		1.8 D Hatchback	44	06.93-06.97	DISC BRAKE	<b>KV 219</b>
<b>KF 142</b>		1.8 D Hatchback	44	06.93-06.97		<b>KB 008</b>
<b>KF 142</b>		1.8 D Hatchback	44	06.93-06.97	DISC BRAKE	<b>KV 219</b>
<b>KF 143</b>		1.8 D Hatchback	44	06.93-06.97		<b>KB 008</b>
<b>KF 143</b>		1.8 D Estate Car	44	10.93-10.97		
<b>KF 142</b>		1.8 D Estate Car	44	10.93-10.97		<b>KV 305</b>
<b>KF 143</b>		1.9 D Hatchback	47	03.91-06.97	DISC BRAKE	<b>KV 219</b>
<b>KF 143</b>		1.9 D Hatchback	47	03.91-06.97		<b>KB 008</b>
<b>KF 143</b>		1.9 D Estate Car	47	10.93-10.97		
<b>KF 143</b>		1.9 D Hatchback	50	06.94-06.97	DISC BRAKE	<b>KV 219</b>
<b>KF 143</b>		1.9 D Hatchback	50	06.94-06.97		<b>KB 008</b>
<b>KF 143</b>		1.9 D Estate Car	50	06.94-10.97		
<b>KF 143</b>		1.9 TD Estate Car	66	10.93-10.97		
<b>DACIA</b>						
<b>1300</b>						
<b>KC 149</b>	10.77 -->	1.3 Estate Car	40	12.72-05.83		<b>KA 043</b>
		1.3 Limousine	40	12.72-05.83	--> 09.77	<b>KA 043</b>
<b>KC 149</b>	10.77 -->	1.3 Limousine	40	12.72-05.83	10.77 -->	<b>KA 044</b>

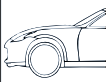
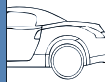

	<b>i</b>	<b>ENGINE</b>	<b>POWER (kW)</b>	<b>YEAR</b>	<b>i</b>	
Fersa KIT FRONT						Fersa KIT REAR
<b>DACIA</b>						
1310						
<b>KC 149</b>		1.3 Estate Car	40	05.83-		<b>KA 043</b>
<b>KC 149</b>		1.3 Limousine	40	05.83-		<b>KA 044</b>
<b>LOGAN</b>						
		1.4; 1.6; 1.6 16V	55-77	09.04-		<b>KB 045</b>
<b>KF 158</b>	<b>ABS</b>	1.4; 1.6; 1.6 16V	55-77	09.04-		<b>KB 045</b>
<b>KF 158</b>	<b>ABS</b>	1.5 dCi	48-63	09.05-		<b>KB 045</b>
<b>LOGAN KOMBI</b>						
<b>KF 158</b>	<b>ABS</b>	1.4; 1.6; 1.6 16V	55-77	02.07-		<b>KB 045</b>
<b>KF 158</b>	<b>ABS</b>	1.5 dCi	50-63	02.07-		
<b>DAEWOO</b>						
<b>ESPERO</b>						
<b>KF 134</b>	<b>ABS</b>	1.5i 16V	66	02.95-06.99	<b>ABS</b>	<b>KA 007</b>
<b>KF 134</b>	<b>ABS</b>	1.8i	66	02.95-09.99	<b>ABS</b>	<b>KA 007</b>
		2.0	74	10.91-09.93	<b>ABS</b>	<b>KV 202</b>
<b>KF 134</b>	<b>ABS</b>	2.0	74	10.91-09.93	<b>ABS</b>	<b>KA 007</b>
<b>KF 134</b>	<b>ABS</b>	2.0i	77	02.95-06.99	<b>ABS</b>	<b>KA 007</b>
<b>LANOS</b>						
		1.4; 1.5; 1.6 16V	55-78	05.97-	<b>ABS</b>	<b>KV 202</b>
		1.4; 1.5; 1.6 16V	55-78	05.97-	<b>ABS</b>	<b>KA 007</b>
<b>NEXIA</b>						
<b>KF 133</b>		1.5; 1.5 Limousine; 1.5 16V	44-66	02.95-08.97	<b>ABS</b>	<b>KA 007</b>
<b>KF 133</b>		1.5 16V Limousine	66	02.95-08.97	<b>ABS</b>	<b>KA 007</b>
<b>REZZO</b>						
<b>KF 138</b>		1.6; 1.6 SX; 1.8; 2.0	66-94	09.00-		
<b>DAF</b>						
44						
<b>KA 068</b>		0.8 Limousine; 0.8 Estate Car	25	11.66-09.74		
55						
<b>KA 068</b>		1.1 Limousine	33	10.67-09.72		
<b>KA 068</b>		1.1 Estate Car; 1.1 Coupe	33	05.68-09.72		
<b>KA 068</b>		1.1 MARATHON Limousine	40	12.71-09.72		
<b>KA 068</b>		1.1 MARATHON Coupe	40	12.71-09.72		
66						
<b>KA 068</b>		1.1 Limousine; 1.1 Estate Car; 1.1 MARATHON Estate Car; 1.1 SL Limousine;	35-42	10.72-08.75		
<b>DAIHATSU</b>						
<b>CHARMANT</b>						
<b>KA 065</b>		1.3; 1.6	48-61	11.81-07.87		

	<b>i</b>	ENGINE	POWER (kW)	YEAR	<b>i</b>	
Fersa KIT FRONT						Fersa KIT REAR
<b>FIAT</b>						
<b>124</b>						
<b>KA 055</b>		1200; 1200 TA; 1400 Sport; 1500 SPECIAL; 1500 SPECIAL T; 1500 Sport BS; 1600 BC1; 1600 Special T; 1600 Sport;	44-94	01.66-12.77		<b>KC 253</b>
<b>125</b>						
<b>KA 056</b>	--> 12.72	1.6 Special TA; 1.6 TA	66-74	07.67-03.74	--> 12.72	<b>KC 253</b>
<b>126</b>						
<b>KA 213</b>		600; 650; 700	17-22	09.72-09.00		<b>KA 210</b>
<b>127</b>						
<b>KF 161</b>	06.73 -->	0.9	29-33	06.71-05.83	01.77 --> / CH.1573629 -->	<b>KV 162</b>
<b>KF 161</b>	CH. 1573629 -->	1.0	37	01.77-12.86	CH. 1573629 -->	<b>KV 162</b>
<b>KF 161</b>		1.0; 1.0 Sport; 1.3 Sport	37-55	04.77-12.86		<b>KV 162</b>
<b>KF 161</b>		1.3 D	33	04.81-12.86		<b>KV 162</b>
<b>128</b>						
<b>KF 161</b>	CH. 1289826--> / CH. --> 2511997	1.1	33	02.75-02.81		
<b>KF 160</b>	CH. 2511998 -->	1.1	33	02.75-02.81		
		1.1	33	02.75-02.81	10.76 -->	<b>KV 162</b>
<b>KF 161</b>	CH. 1289826--> / CH. --> 2511997	1.1	33-40	03.69-12.84		
<b>KF 160</b>	CH. 2511998 -->	1.1	33-40	03.69-12.84		
		1.1	33-40	03.69-12.84	10.76 -->	<b>KV 162</b>
<b>KF 161</b>	CH. 1289826--> / CH. --> 2511997	1.3; 1.3 Sport	44	08.74-12.84		
<b>KF 160</b>	CH. 2511998 -->	1.3; 1.3 Sport	44	08.74-12.84		
		1.3; 1.3 Sport	44	08.74-12.84	10.76 -->	<b>KV 162</b>
<b>KA 057</b>		1.3; 1.3 Mirafiori	40	10.74-09.81		<b>KC 253</b>
<b>KA 057</b>	01.75 -->	1.3 Mirafiori	48	10.74-12.82	01.75 -->	<b>KC 253</b>
<b>KA 057</b>		1.3; 1.3 Mirafiori; 1.4 Mirafiori; 1.4 Super Mirafiori; 1.6; 1.6 CL; 1.6 SUPER; 1.6 Super Mirafiori; 2.0 Abarth Rally;	48-103	10.74-04.85		<b>KC 253</b>
<b>KA 057</b>		2.0 D; 2.4 D; 2.4 SUPER D	44-53	06.78-12.84		<b>KC 253</b>
<b>132</b>						
<b>KA 056</b>		1.6; 1.7 GLS; 1.7 SPECIAL; 2.0; 2.0 GLS; 2.0 i.e.	65-90	04.72-12.82		<b>KC 253</b>
<b>KA 056</b>	--> 12.81	2.0 D; 2.5 D	44-53	07.78-07.82	--> 12.81	<b>KC 253</b>
<b>135 DINO</b>						
<b>KA 056</b>		2.0; 2.4	118-132	10.67-03.74		
<b>KB 011</b>		1.6; 1.9	46-51	10.75-07.82		<b>KB 012</b>
<b>KB 011</b>		2.2 D	46	10.75-08.80		<b>KB 012</b>
<b>500</b>						
		0.5; 0.6	11-13	01.57-01.76		<b>KA 210</b>
<b>600</b>						
<b>KA 213</b>	01.64 --> / --> 12.70	0.8	17	10.60-02.71	01.64 --> / --> 12.70	<b>KA 210</b>
<b>850</b>						
<b>KA 213</b>		0.8; 0.8 Special; Sport; Sport Spider	25-38	07.64-12.72		
<b>1000-SERIE</b>						
<b>KA 056</b>	01.65 -->	1300	45	11.61-02.67		
<b>KA 056</b>	01.65 --> / --> 12.67	1500	49-55	11.61-03.69		
<b>KA 056</b>	01.65 -->	1.5	49-55	06.64-10.67		
<b>KA 056</b>	01.65 --> / --> 12.67	1500 L; 2300	55-75	07.62-12.70		
<b>KF 288</b>		1.2	51	10.07-	ABS	<b>KV 251</b>
<b>KF 283</b>	ABS	1.4	74	10.07-	ABS	<b>KV 251</b>
<b>KF 283</b>	ABS	1.3 D Multijet	55	10.07-	ABS	<b>KV 251</b>
<b>ARGENTA (132A)</b>						
<b>KA 056</b>		1600; 2000; 2000 i.e.; 2000 Volumax	66-99	06.78-07.86		<b>KC 253</b>
<b>KA 056</b>		2500 D; 2500 TD	53-66	06.81-11.85		<b>KC 253</b>

	<b>i</b>	<b>ENGINE</b>	<b>POWER (kW)</b>	<b>YEAR</b>	<b>i</b>	
Fersa KIT FRONT						Fersa KIT REAR
<b>FIAT</b>						
<b>BARCETTA (183)</b>						
<b>KF 166</b>	ABS / --> 05.99 / VIN. --> 43318	1.8 16V	96	04.95-	ABS / --> 05.99	<b>KV 237</b>
<b>KF 283</b>	ABS / 06.99 --> VIN. 43319-->	1.8 16V	96	04.95-	ABS / 06.99 -->	<b>KV 251</b>
<b>KF 166</b>	<b>ABS</b>	1.8 16V	96	04.95-	<b>ABS</b>	<b>KV 164</b>
<b>BRAVA (182)</b>						
<b>KF 168</b>		1.4 12V; 1.9D	59-60	95-98		<b>KV 164</b>
<b>KF 168</b>		1.6 16V	59-60	95-09.98		<b>KV 164</b>
<b>KF 346</b>	ABS	1.2 16V 80	59-60	12.98-10.01		<b>KV 251</b>
<b>KF 165</b>	<b>ABS</b>	1.2 16V 80	59-60	12.98-10.01	<b>ABS</b>	<b>KV 164</b>
		1.2 16V 80	59-60	12.98-10.01		<b>KV 251</b>
		1.4; 1.6 16V	55-76	10.95-10.01	ABS / --> 09.98	<b>KV 237</b>
<b>KF 346</b>	ABS / 10.98 -->	1.4; 1.6 16V	55-76	10.95-10.01	ABS / 10.98 -->	<b>KV 251</b>
<b>KF 165</b>	<b>ABS</b>	1.4; 1.6 16V	55-76	10.95-10.01	<b>ABS</b>	<b>KV 164</b>
<b>KF 168</b>		1.6 16V AUT	83	09.98-		<b>KV 164</b>
<b>KF 283</b>	ABS / --> 07.98	1.8 GT 16V	83	10.95-10.01	ABS / --> 07.98	<b>KV 251</b>
<b>KF 166</b>	<b>ABS</b>	1.8 GT 16V	83	10.95-10.01	<b>ABS</b>	<b>KV 164</b>
		1.9 TD 100 S; 1.9 TD 75 S	55-74	03.96-10.01	ABS / --> 07.98	<b>KV 237</b>
<b>KF 283</b>	ABS / 08.98 -->	1.9 TD 100 S; 1.9 TD 75 S	55-74	03.96-10.01	ABS / 08.98 -->	<b>KV 251</b>
<b>KF 166</b>	<b>ABS</b>	1.9 TD 100 S; 1.9 TD 75 S	55-74	03.96-10.01	<b>ABS</b>	<b>KV 164</b>
<b>KF 283</b>	ABS	1.9 JTD 105	77	12.98-10.01		<b>KV 251</b>
<b>KF 166</b>	<b>ABS</b>	1.9 JTD 105	77	12.98-10.01	<b>ABS</b>	<b>KV 164</b>
<b>KF 166</b>	ABS	1.9 JTD 105	77	12.98-10.01		
		1.9 D	48	10.95-10.01	ABS / --> 12.98	<b>KV 237</b>
<b>KF 346</b>	ABS / 01.99 -->	1.9 D	48	10.95-10.01	ABS / 01.99 -->	<b>KV 251</b>
<b>KF 165</b>	<b>ABS</b>	1.9 D	48	10.95-10.01	<b>ABS</b>	<b>KV 164</b>
<b>BRAVO (182)</b>						
<b>KF 168</b>		1.4 12V; 1.9D	59-60	95-98		<b>KV 164</b>
<b>KF 168</b>		1.6 16V	59-60	95-09.98		<b>KV 164</b>
<b>KF 346</b>	ABS	1.2 16V 80	59-60	12.98-10.01	ABS	<b>KV 251</b>
		1.2 16V 80	59-60	12.98-10.01	<b>ABS</b>	<b>KV 164</b>
<b>KF 165</b>	<b>ABS</b>	1.2 16V 80	59-60	12.98-10.01	<b>ABS</b>	<b>KV 164</b>
<b>KF 168</b>		1.2 16V	55-76	99-		<b>KV 164</b>
		1.4; 1.6 16V	55-76	10.95-10.01	ABS / --> 09.98	<b>KV 237</b>
<b>KF 346</b>	ABS / 10.98 -->	1.4; 1.6 16V	55-76	10.95-10.01	ABS / 10.98 -->	<b>KV 251</b>
<b>KF 165</b>	<b>ABS</b>	1.4; 1.6 16V	55-76	10.95-10.01	<b>ABS</b>	<b>KV 164</b>
<b>KF 168</b>		1.6 16V AUT	83	09.98-		<b>KV 164</b>
		1.8 GT	83	10.95-10.01	ABS / --> 07.98	<b>KV 237</b>
<b>KF 283</b>	ABS / 08.98 -->	1.8 GT	83	10.95-10.01	ABS / 08.98 -->	<b>KV 251</b>
<b>KF 166</b>	<b>ABS</b>	1.8 GT	83	10.95-10.01	<b>ABS</b>	<b>KV 164</b>
<b>KF 264</b>		2.0 HGT 20V	108	10.95-07.98	ABS	<b>KV 237</b>
<b>KF 264</b>		2.0 HGT 20V	108	10.95-07.98	<b>ABS</b>	<b>KV 164</b>
<b>KF 264</b>		2.0 HGT 20V	113	07.98-10.01	ABS	<b>KV 251</b>
<b>KF 264</b>		2.0 HGT 20V	113	07.98-10.01	<b>ABS</b>	<b>KV 164</b>
		1.9 TD 100 S; 1.9 TD 75 S	55-74	03.96-10.01	ABS / --> 07.98	<b>KV 237</b>
<b>KF 283</b>	ABS / 08.98 -->	1.9 TD 100 S; 1.9 TD 75 S	55-74	03.96-10.01	ABS / 08.98 -->	<b>KV 251</b>
<b>KF 166</b>	<b>ABS</b>	1.9 TD 100 S; 1.9 TD 75 S	55-74	03.96-10.01	<b>ABS</b>	<b>KV 164</b>
<b>KF 283</b>	ABS	1.9 JTD 105	77	12.98-10.01	ABS	<b>KV 251</b>
<b>KF 166</b>	<b>ABS</b>	1.9 JTD 105	77	12.98-10.01	<b>ABS</b>	<b>KV 164</b>
<b>KF 166</b>	ABS	1.9 JTD 105	77	12.98-10.01	ABS	<b>KV 251</b>
<b>KF 165</b>	ABS / --> 12.98	1.9 D	48	10.95-10.01	ABS / --> 12.98	<b>KV 237</b>
<b>KF 346</b>	ABS / 01.99 -->	1.9 D	48	10.95-10.01	ABS / 01.99 -->	<b>KV 251</b>

	<b>i</b>	<b>ENGINE</b>	<b>POWER (kW)</b>	<b>YEAR</b>	<b>i</b>	
Fersa KIT FRONT						Fersa KIT REAR
<b>FIAT</b>						
<b>BRAVO (182)</b>						
<b>KF 165</b>	<b>ABS</b>	1.9 D	48	10.95-10.01	<b>ABS</b>	<b>KV 164</b>
		1.4; 1.4 T-Jet	66-110	04.07-	<b>ABS</b>	<b>KV 251</b>
		1.9 D Multijet	88-110	04.07-	<b>ABS</b>	<b>KV 251</b>
<b>CINQUECENTO (170)</b>						
		0.7; 0.9; 0.9 i.e.; 0.9 i.e. S; 1.1 Sporting	22-40	07.91-07.99		<b>KV 162</b>
<b>COUPE (FA/175)</b>						
<b>KF 166</b>	<b>ABS</b>	1.8 16V; 2.0 16V	96-102	11.93-08.00	<b>ABS</b>	<b>KV 218</b>
<b>KF 166</b>	<b>ABS</b>	1.8 16V; 2.0 16V	96-102	11.93-08.00	<b>ABS</b>	<b>KV 164</b>
<b>KF 264</b>		2.0 16V TURBO; 2.0 20V; 2.0 20V TURBO	108-162	11.93-08.00	<b>ABS</b>	<b>KV 218</b>
<b>KF 264</b>		2.0 16V TURBO; 2.0 20V; 2.0 20V TURBO	108-162	11.93-08.00	<b>ABS</b>	<b>KV 164</b>
<b>CROMA (154)</b>						
<b>KF 261</b>		1600	61	12.85-12.90		
<b>KF 261</b>		2000 CHT	66	12.85-02.89		
<b>KF 261</b>		2000 CHT	74	01.91-09.92		
<b>KF 261</b>		2000 i.e.	83	03.86-09.90		
<b>KF 261</b>	--> 11.92 / CH. --> 2025078	2000 i.e.	85	10.87-08.96		
<b>KF 264</b>	11.92 --> / CH. 2025079 -->	2000 i.e.	85	10.87-08.96		
<b>KF 261</b>		2000 i.e.	88	03.87-09.92		
<b>KF 264</b>		2000 16V	101	08.92-08.96		
<b>KF 261</b>	--> 11.92 / CH. --> 2025078	2000 i.e. TURBO	110	06.87-08.96		
<b>KF 264</b>	11.92 --> / CH. 2025079 -->	2000 i.e. TURBO	110	06.87-08.96		
<b>KF 261</b>		2000 i.e. TURBO	111	11.86-11.88		
<b>KF 261</b>		2000 i.e. TURBO	114	12.85-06.90		
<b>KF 264</b>		2500 V6	119	06.93-08.96		
<b>KF 261</b>		2000 TD i.d.; 2500 D; 2500 TD	55-74	12.85-10.92		
<b>KF 264</b>		2500 TDE	77	12.91-08.96		
<b>KF 261</b>	--> 11.92 / CH. --> 2025078	2500 TD	85	05.89-08.96		
<b>KF 264</b>	11.92 --> / CH. 2025079 -->	2500 TD	85	05.89-08.96		
<b>CROMA (194)</b>						
<b>KV 343</b>		1.8 16V; 2.2 16V	103-108	06.05-	<b>ABS</b>	<b>KV 336</b>
<b>KV 343</b>		1.9 D Multijet; 2.4 D Multijet	88-147	06.05-	<b>ABS</b>	<b>KV 336</b>
<b>DOBLO (119, 223)</b>						
		1.2	48-76	03.01-01.05		<b>KF 167</b>
<b>KF 283</b>	<b>ABS</b>	1.2; 1.4; 1.6 16V; 1.6 Natural Power	48-76	03.01-		
<b>KF 166</b>	<b>ABS</b>	1.2; 1.4; 1.6 16V; 1.6 Natural Power	48-76	03.01-		
<b>KF 283</b>	<b>ABS</b>	1.3 D Multijet; 1.3 JTD 16V; 1.9 D; 1.9 D Multijet; 1.9 JTD	46-88	03.01-		
<b>KF 166</b>	<b>ABS</b>	1.3 D Multijet; 1.3 JTD 16V; 1.9 D; 1.9 D Multijet; 1.9 JTD	46-88	03.01-		
		1.6 16V, 1.9 D	46-88	03.01-01.05		<b>KF 167</b>
<b>DUCATO (230)</b>						
<b>KA 079</b>	--> 11.01 / 1000*1400[kg]	2.0; 2.0 Panorama	80	03.94-04.02	--> 11.01 / 1000*1400[kg]	<b>KA 013</b>
<b>KA 272</b>	--> 11.01 / 1800[kg]	2.0; 2.0 Panorama	80	03.94-04.02	--> 11.01 / 1800[kg]	<b>KA 080</b>
<b>KA 079</b>	12.01 --> / 1000*1400[kg]	2.0; 2.0 Panorama	80	03.94-04.02		
<b>KA 272</b>	12.01 --> / 1800[kg]	2.0; 2.0 Panorama	80	03.94-04.02		
<b>KA 079</b>	--> 11.01 / 1000*1400[kg]	2.0 4x4	80	06.98-04.02	--> 11.01 / 1000*1400[kg]	<b>KA 079</b>
<b>KA 272</b>	--> 11.01 / 1800[kg]	2.0 4x4	80	06.98-04.02		
<b>KA 079</b>	12.01 --> / 1000*1400[kg]	2.0 4x4	80	06.98-04.02		
<b>KA 272</b>	12.01 --> / 1800[kg]	2.0 4x4	80	06.98-04.02		
<b>KA 079</b>	--> 11.01 / 1000*1400[kg]	1.9 D; 1.9 D Combinato; 1.9 TD; 1.9 TD CAT; 1.9 TD Combinato; 1.9 TD Panorama; 2.0 JTD; 2.5 D; 2.5 D Combinato; 2.5 TDI; 2.5 TDI Combinato; 2.5 TDI Maxi; 2.5 TDI Panorama	50-85	03.94-04.02	--> 11.01 / 1000*1400[kg]	<b>KA 013</b>

	<b>i</b>	<b>ENGINE</b>	<b>POWER (kW)</b>	<b>YEAR</b>	<b>i</b>	
Fersa KIT FRONT						Fersa KIT REAR
<b>FIAT</b>						
<b>DUCATO (230)</b>						
<b>KA 272</b>	--> 11.01 / 1800[kg]	1.9 D; 1.9 D Combinato; 1.9 TD; 1.9 TD CAT; 1.9 TD Combinato; 1.9 TD Panorama; 2.0 JTD; 2.5 D; 2.5 D Combinato; 2.5 TDI; 2.5 TDI Combinato; 2.5 TDI Maxi; 2.5 TDI Panorama	50-85	03.94-04.02	--> 11.01 / 1800[kg]	<b>KA 080</b>
<b>KA 079</b>	12.01 --> / 1000*1400[kg]	1.9 D; 1.9 D Combinato; 1.9 TD; 1.9 TD CAT; 1.9 TD Combinato; 1.9 TD Panorama; 2.0 JTD; 2.5 D; 2.5 D Combinato; 2.5 TDI; 2.5 TDI Combinato; 2.5 TDI Maxi; 2.5 TDI Panorama	50-85	03.94-04.02		
<b>KA 272</b>	12.01 --> / 1800[kg]	1.9 D; 1.9 D Combinato; 1.9 TD; 1.9 TD CAT; 1.9 TD Combinato; 1.9 TD Panorama; 2.0 JTD; 2.5 D; 2.5 D Combinato; 2.5 TDI; 2.5 TDI Combinato; 2.5 TDI Maxi; 2.5 TDI Panorama	50-85	03.94-04.02		
<b>KA 079</b>	--> 11.01 / 1000*1400[kg]	2.5 D 4x4; 2.5 TDI 4x4	62-85	03.94-04.02	--> 11.01 / 1000*1400[kg]	<b>KA 079</b>
<b>KA 272</b>	--> 11.01 / 1800[kg]	2.5 D 4x4; 2.5 TDI 4x4	62-85	03.94-04.02		
<b>KA 079</b>	12.01 --> / 1000*1400[kg]	2.5 D 4x4; 2.5 TDI 4x4	62-85	03.94-04.02		
<b>KA 272</b>	12.01 --> / 1800[kg]	2.5 D 4x4; 2.5 TDI 4x4	62-85	03.94-04.02		
<b>KA 079</b>	--> 11.01 / 1000*1400[kg]	2.8 JTD	94	11.00-04.02	--> 11.01 / 1000*1400[kg]	<b>KA 013</b>
<b>KA 272</b>	--> 11.01 / 1800[kg]	2.8 JTD	94	11.00-04.02	--> 11.01 / 1800[kg]	<b>KA 080</b>
<b>KA 079</b>	12.01 --> / 1000*1400[kg]	2.8 JTD	94	11.00-04.02		
<b>KA 272</b>	12.01 --> / 1800[kg]	2.8 JTD	94	11.00-04.02		
<b>KA 079</b>	--> 11.01 / 1000*1400[kg]	2.8 JTD 4x4	94	11.00-04.02	--> 11.01 / 1000*1400[kg]	<b>KA 079</b>
<b>KA 272</b>	--> 11.01 / 1800[kg]	2.8 JTD 4x4	94	11.00-04.02		
<b>KA 079</b>	12.01 --> / 1000*1400[kg]	2.8 JTD 4x4	94	11.00-04.02		
<b>KA 272</b>	12.01 --> / 1800[kg]	2.8 JTD 4x4	94	11.00-04.02		
<b>KA 079</b>	--> 11.01 / 1000*1400[kg]	2.8 D; 2.8 TDI	64-90	10.97-04.02	--> 11.01 / 1000*1400[kg]	<b>KA 013</b>
<b>KA 272</b>	--> 11.01 / 1800[kg]	2.8 D; 2.8 TDI	64-90	10.97-04.02	--> 11.01 / 1800[kg]	<b>KA 080</b>
<b>KA 079</b>	12.01 --> / 1000*1400[kg]	2.8 D; 2.8 TDI	64-90	10.97-04.02		
<b>KA 272</b>	12.01 --> / 1800[kg]	2.8 D; 2.8 TDI	64-90	10.97-04.02		
<b>KA 079</b>	--> 11.01 / 1000*1400[kg]	2.8 D 4x4; 2.8 TDI 4x4	64-90	08.98-04.02	--> 11.01 / 1000*1400[kg]	<b>KA 079</b>
<b>KA 272</b>	--> 11.01 / 1800[kg]	2.8 D 4x4; 2.8 TDI 4x4	64-90	08.98-04.02		
<b>KA 079</b>	12.01 --> / 1000*1400[kg]	2.8 D 4x4; 2.8 TDI 4x4	64-90	08.98-04.02		
<b>KA 272</b>	12.01 --> / 1800[kg]	2.8 D 4x4; 2.8 TDI 4x4	64-90	08.98-04.02		
<b>DUCATO (244)</b>						
<b>KA 079</b>	--> 05.04 / 1100*1500[kg]	2.0 Bus; 2.0 Box Wagon; 2.0 Bipower Bus; 2.0 Bipower Box Wagon	81	04.02-		
<b>KA 272</b>	--> 05.04 / 1800[kg]	2.0 Bus; 2.0 Box Wagon; 2.0 Bipower Bus; 2.0 Bipower Box Wagon	81	04.02-		
<b>KA 079</b>	--> 05.04 / 1100*1500[kg]	2.0 4x4	81	05.02-07.06		
<b>KA 272</b>	--> 05.04 / 1800[kg]	2.0 4x4	81	05.02-07.06		
<b>KA 079</b>	05.04/ 1100/15000[kg]	2.0 4x4	81	05.02-07.06		
<b>KA 079</b>	--> 05.04 / 1100*1500[kg]	2.0 JTD Bus; 2.0 JTD Box Wagon; 2.0 JTD Platform; 2.3 JTD Bus; 2.3 JTD Box Wagon; 2.3 JTD Platform; 2.8 JTD Bus; 2.8 JTD Box Wagon; 2.8 JTD Platform	62-94	04.02-		
<b>KA 272</b>	--> 05.04 / 1800[kg]	2.0 JTD Bus; 2.0 JTD Box Wagon; 2.0 JTD Platform; 2.3 JTD Bus; 2.3 JTD Box Wagon; 2.3 JTD Platform; 2.8 JTD Bus; 2.8 JTD Box Wagon; 2.8 JTD Platform	62-94	04.02-		
<b>KA 079</b>	--> 05.04 / 1100*1500[kg]	2.8 JTD 4x4 Bus; 2.8 JTD 4x4 Box Wagon; 2.8 JTD 4x4 Platform	94	07.02-		
<b>KA 272</b>	--> 05.04 / 1800[kg]	2.8 JTD 4x4 Bus; 2.8 JTD 4x4 Box Wagon; 2.8 JTD 4x4 Platform	94	07.02-		
<b>KA 079</b>	--> 05.04 / 1100*1500[kg]	2.8 4x4	90	11.03-07.06		
<b>KA 272</b>	--> 05.04 / 1800[kg]	2.8 4x4	90	11.03-07.06		
<b>KA 079</b>	--> 05.04 / 1100*1500[kg]	2.8; 2.8 JTD	90-107	11.03-07.06		
<b>KA 272</b>	--> 05.04 / 1800[kg]	2.8; 2.8 JTD	90-107	11.03-07.06		
<b>KA 079</b>	--> 05.04 / 1100*1500[kg]	2.8 JTD Power	107	05.04-		
<b>KA 272</b>	--> 05.04 / 1800[kg]	2.8 JTD Power	107	05.04-		

		ENGINE	POWER (kW)	YEAR		
Fersa KIT FRONT						Fersa KIT REAR
<b>FIAT</b>						
<b>DUCATO (280)</b>						
<b>KA 009</b>	CH. --> 604496	1.8 Bus; 1.8 Box Wagon; 2.0 Bus; 2.0 Box Wagon; 2.0 Platform	49-62	01.82-08.90		
<b>KA 079</b>	CH. 604497 -->	1.8 Bus; 1.8 Box Wagon; 2.0 Bus; 2.0 Box Wagon; 2.0 Platform	49-62	01.82-08.90		
		1.8 Bus; 1.8 Box Wagon; 2.0 Bus; 2.0 Box Wagon; 2.0 Platform	49-62	01.82-08.90	CH.--> 278757 / 1000*1300[kg]	<b>KA 010</b>
		1.8 Bus; 1.8 Box Wagon; 2.0 Bus; 2.0 Box Wagon; 2.0 Platform	49-62	01.82-08.90	CH. 278758 --> / 1000[kg]	<b>KA 058</b>
		1.8 Bus; 1.8 Box Wagon; 2.0 Bus; 2.0 Box Wagon; 2.0 Platform	49-62	01.82-08.90	1400[kg]	<b>KA 058</b>
		1.8 Bus; 1.8 Box Wagon; 2.0 Bus; 2.0 Box Wagon; 2.0 Platform	49-62	01.82-08.90	1800[kg]	<b>KA 200</b>
<b>KA 009</b>	CH --> 604496	1.9 D Bus; 1.9 D Box Wagon; 1.9 D Platform; 1.9 TD Box Wagon; 1.9 TD Platform; 2.4 D Bus; 2.4 D Box Wagon; 2.5 D Bus; 2.5 D Box Wagon; 2.5 D Platform; 2.5 TD Platform; 2.5 TD Panorama Bus	52-68	01.82-08.90		
<b>KA 079</b>	CH 604497 -->	1.9 D Bus; 1.9 D Box Wagon; 1.9 D Platform; 1.9 TD Box Wagon; 1.9 TD Platform; 2.4 D Bus; 2.4 D Box Wagon; 2.5 D Bus; 2.5 D Box Wagon; 2.5 D Platform; 2.5 TD Platform; 2.5 TD Panorama Bus	52-68	01.82-08.90		
		1.9 D Bus; 1.9 D Box Wagon; 1.9 D Platform; 1.9 TD Box Wagon; 1.9 TD Platform; 2.4 D Bus; 2.4 D Box Wagon; 2.5 D Bus; 2.5 D Box Wagon; 2.5 D Platform; 2.5 TD Platform; 2.5 TD Panorama Bus	52-68	01.82-08.90	CH.--> 278757 / 1000*1300[kg]	<b>KA 010</b>
		1.9 D Bus; 1.9 D Box Wagon; 1.9 D Platform; 1.9 TD Box Wagon; 1.9 TD Platform; 2.4 D Bus; 2.4 D Box Wagon; 2.5 D Bus; 2.5 D Box Wagon; 2.5 D Platform; 2.5 TD Platform; 2.5 TD Panorama Bus	52-68	01.82-08.90	CH. 278758 --> / 1000[kg]	<b>KA 058</b>
		1.9 D Bus; 1.9 D Box Wagon; 1.9 D Platform; 1.9 TD Box Wagon; 1.9 TD Platform; 2.4 D Bus; 2.4 D Box Wagon; 2.5 D Bus; 2.5 D Box Wagon; 2.5 D Platform; 2.5 TD Platform; 2.5 TD Panorama Bus	52-68	01.82-08.90	1400[kg]	<b>KA 058</b>
		1.9 D Bus; 1.9 D Box Wagon; 1.9 D Platform; 1.9 TD Box Wagon; 1.9 TD Platform; 2.4 D Bus; 2.4 D Box Wagon; 2.5 D Bus; 2.5 D Box Wagon; 2.5 D Platform; 2.5 TD Platform; 2.5 TD Panorama Bus	52-68	01.82-08.90	1800[kg]	<b>KA 200</b>
<b>KA 079</b>		2.5 D 4x4 Bus; 2.5 D 4x4 Box Wagon; 2.5 D 4x4 Platform; 2.5 TD 4x4 Bus	55-68	01.86-08.90		<b>KA 079</b>
<b>DUCATO (290)</b>						
<b>KA 079</b>		2.0 Bus; 2.0 Platform	62	07.90-03.94	1000/1400[kg]	<b>KA 058</b>
<b>KA 079</b>		2.0 Bus; 2.0 Platform	62	07.90-03.94	1800[kg]	<b>KA 200</b>
<b>KA 079</b>		1.9 D Bus; 1.9 D Box Wagon; 1.9 TD Bus; 1.9 TD Box Wagon; 1.9 TD Platform; 2.5 D Bus; 2.5 D Platform; 2.5 TD Bus; 2.5 TD Box Wagon; 2.5 TDI Platform	52-70	03.89-03.94	1000/1400[kg]	<b>KA 058</b>
<b>KA 079</b>		1.9 D Bus; 1.9 D Box Wagon; 1.9 TD Bus; 1.9 TD Box Wagon; 1.9 TD Platform; 2.5 D Bus; 2.5 D Platform; 2.5 TD Bus; 2.5 TD Box Wagon; 2.5 TDI Platform	52-70	03.89-03.94	1800[kg]	<b>KA 200</b>
<b>KA 079</b>		2.5 D 4x4 Bus; 2.5 D 4x4 Box Wagon; 2.5 D 4x4 Platform; 2.5 TD 4x4 Bus;	55-70	07.90-03.94		<b>KA 079</b>
<b>DUNA (146B)</b>						
<b>KF 160</b>	CH. --> 3403006 / CH. --> 7344312	60 1.1; 70 1,3	43-49	01.87-12.91	ABS	<b>KV 162</b>
<b>KF 160</b>	CH. --> 3403006 / CH. --> 7344312	DS 1.7	44	01.87-12.91	ABS	<b>KV 162</b>
<b>FIORINO (127)</b>						
<b>KF 161</b>		900	33	10.77-12.84	--> 12.79 / CH. --> 7027675	<b>KV 162</b>
<b>KF 160</b>		1050	37	01.80-12.87		
<b>FIORINO (146 UNO)</b>						
<b>KF 167</b>	01.94 -->	70 1,3	49	01.88-12.94		
<b>KF 167</b>		70 i.e. 1.4	49	05.94-05.01		

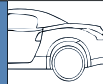

	<b>i</b>	<b>ENGINE</b>	<b>POWER (kW)</b>	<b>YEAR</b>	<b>i</b>	
Fersa KIT FRONT						Fersa KIT REAR
<b>FIAT</b>						
<b>FIORINO (146 UNO)</b>						
<b>KF 167</b>		75 i.e. 1.6	55	10.93-05.01		
<b>KF 167</b>		65 1.7 TD	46	01.97-05.01		
<b>FIORINO (146)</b>						
<b>KF 167</b>		1.4; 1.6	49-55	01.94-05.01		
<b>KF 167</b>		1.7 D	42	10.93-10.99		
<b>KF 167</b>		1.7 D	44	05.88-10.99		
<b>KF 167</b>		1.7 TD	46	01.97-05.01		
<b>FIORINO (147)</b>						
<b>KF 160</b>	CH.--> 8051673	1.0 Pick-Up; 1.1 Pick-Up	37-41	10.82-12.88		
<b>KF 160</b>	--> 03.88 / CH.--> 8051673	1.0 Box Wagon; 1.1 Box Wagon; 1.3 Box Wagon; 1.5 Box Wagon	40-55	11.86-08.93		
<b>KF 160</b>	CH.--> 8051673	1.3 D Pick-Up; 1.3 D Box Wagon	33	03.82-12.88		
<b>KF 160</b>	--> 03.88 / CH.--> 8051673	1.7 D Box Wagon	42-44	12.87-		
<b>IDEA</b>						
<b>KF 346</b>	ABS	1.2; 1.4	57-70	01.04-	ABS	<b>KV 251</b>
<b>KF 283</b>	ABS	1.3 D Multijet; 1.3 JTD; 1.9 JTD	51-74	01.04-	ABS	<b>KV 251</b>
<b>MAREA (185)</b>						
<b>KF 346</b>	ABS	1.2 16V Limousine; 1.2 16V Estate Car	60	10.98-	ABS	<b>KV 251</b>
		1.2 16V Limousine; 1.2 16V Estate Car	60	10.98-	ABS	<b>KV 251</b>
<b>KF 165</b>	<del>ABS</del>	1.2 16V Limousine; 1.2 16V Estate Car	60	10.98-	<del>ABS</del>	<b>KV 164</b>
<b>KF 168</b>	ABS	1.4i 12V	59	96-	ABS	<b>KV 164</b>
<b>KF 165</b>	ABS / --> 06.98 / VIN. --> 176271 / VIN. --> 5054833 / VIN. --> 180746	1.4 12V Limousine; 1.4 12V Estate Car	59	09.96-	ABS / --> 06.98, VIN. --> 176271 / VIN. --> 5054833 / VIN. --> 180746	<b>KV 237</b>
<b>KF 346</b>	ABS / 07.98--> / VIN.176272--> / VIN.5054834 --> / VIN.180747 -->	1.4 12V Limousine; 1.4 12V Estate Car	59	09.96-	ABS / 07.98--> / VIN.176272--> / VIN.5054834 --> / VIN.180747 -->	<b>KV 251</b>
<b>KF 165</b>		1.4 12V Limousine; 1.4 12V Estate Car	59	09.96-		<b>KV 164</b>
<b>KF 166</b>	ABS / --> 06.98 / VIN. --> 176271 / VIN. --> 5054833 / VIN. --> 180746	1.6 16V Limousine; 1.6 16V Estate Car	76	09.96-	ABS / --> 06.98 / VIN. --> 176271 / VIN. --> 5054833 / VIN. --> 180746	<b>KV 237</b>
<b>KF 283</b>	ABS / 07.98--> / VIN.176272--> / VIN.5054834 --> / VIN.180747 -->	1.6 16V Limousine; 1.6 16V Estate Car	76	09.96-	ABS / 07.98--> / VIN.176272--> / VIN.5054834 --> / VIN.180747 -->	<b>KV 251</b>
<b>KF 166</b>	<del>ABS</del>	1.6 16V Limousine; 1.6 16V Estate Car	76	09.96-	<del>ABS</del>	<b>KV 164</b>
<b>KF 283</b>	ABS	1.6 100 16V Bipower Limousine	76	04.99-	ABS	<b>KV 251</b>
<b>KF 166</b>	<del>ABS</del>	1.6 100 16V Bipower Limousine	76	04.99-	<del>ABS</del>	<b>KV 164</b>
<b>KF 283</b>	ABS	1.6 100 16V Bipower Limousine	76	04.99-	<del>ABS</del>	<b>KV 164</b>
<b>KF 166</b>	<del>ABS</del>	1.6 100 16V Bipower Limousine	76	04.99-	ABS	<b>KV 251</b>
<b>KF 166</b>	ABS / --> 06.98, VIN. --> 176271 / VIN. --> 5054833 / VIN. --> 180746	1.8 16V Limousine; 1.8 16V Estate Car	83	09.96-	ABS / --> 06.98, VIN. --> 176271 / VIN. --> 5054833 / VIN. --> 180746	<b>KV 237</b>
<b>KF 283</b>	ABS / 07.98--> / VIN.176272--> / VIN.5054834 --> / VIN.180747 -->	1.8 16V Limousine; 1.8 16V Estate Car	83	09.96-	ABS / 07.98--> / VIN.176272--> / VIN.5054834 --> / VIN.180747 -->	<b>KV 251</b>
<b>KF 166</b>	<del>ABS</del>	1.8 16V Limousine; 1.8 16V Estate Car	83	09.96-	<del>ABS</del>	<b>KV 164</b>
<b>KF 264</b>	ABS / --> 06.98 / VIN. --> 176271 / VIN. --> 5054833 / VIN. --> 180746	2.0 20V Limousine; 2.0 20V Estate Car	108	09.96-04.99	ABS / --> 06.98 / VIN. --> 176271 / VIN. --> 5054833 / VIN. --> 180746	<b>KV 237</b>
		2.0 20V Limousine; 2.0 20V Estate Car	108	09.96-04.99	ABS / 07.98 --> / VIN.176272 --> / VIN.180747 --> / VIN.5054834 -->	<b>KV 251</b>
<b>KF 264</b>		2.0 20V Limousine; 2.0 20V Estate Car	108	09.96-04.99	<del>ABS</del>	<b>KV 164</b>
<b>KF 264</b>		2.0 150 20V Limousine; 2.0 150 20V Estate Car; 2.0 20V Limousine; 2.0 20V Estate Car	110-113	04.99-	<del>ABS</del>	<b>KV 164</b>

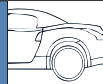
	<b>i</b>	<b>ENGINE</b>	<b>POWER (kW)</b>	<b>YEAR</b>	<b>i</b>	
Fersa KIT FRONT						Fersa KIT REAR
<b>FIAT</b>						
<b>MAREA (185)</b>						
<b>KF 264</b>		2.0 150 20V Limousine; 2.0 150 20V Estate Car; 2.0 20V Limousine; 2.0 20V Estate Car	110-113	04.99-	ABS	<b>KV 251</b>
<b>KF 166</b>	ABS / --> 06.98, VIN. --> 176271 / VIN. --> 5054833 / VIN. --> 180746	1.9 TD 100 Limousine; 1.9 TD 100 Estate Car; 1.9 TD 75 Limousine; 1.9 TD 75 Estate Car	55-74	09.96-	ABS / --> 06.98, VIN. --> 176271 / VIN. --> 5054833 / VIN. --> 180746	<b>KV 237</b>
<b>KF 283</b>	ABS / 07.98--> / VIN.176272--> / VIN.5054834 --> / VIN.180747 -->	1.9 TD 100 Limousine; 1.9 TD 100 Estate Car; 1.9 TD 75 Limousine; 1.9 TD 75 Estate Car	55-74	09.96-	ABS / 07.98--> / VIN.176272--> / VIN.5054834 --> / VIN.180747 -->	<b>KV 251</b>
<b>KF 166</b>	<b>ABS</b>	1.9 TD 100 Limousine; 1.9 TD 100 Estate Car; 1.9 TD 75 Limousine; 1.9 TD 75 Estate Car	55-74	09.96-	<b>ABS</b>	<b>KV 164</b>
<b>KF 283</b>	ABS	1.9 JTD Limousine; 1.9 JTD Estate Car; 1.9 JTD 110 Limousine; 1.9 JTD 110 Estate Car	77-81	04.99-		
<b>KF 166</b>	ABS	1.9 JTD Limousine; 1.9 JTD Estate Car; 1.9 JTD 110 Limousine; 1.9 JTD 110 Estate Car	77-81	04.99-	ABS	<b>KV 251</b>
<b>KF 166</b>	<b>ABS</b>	1.9 JTD Limousine; 1.9 JTD Estate Car; 1.9 JTD 110 Limousine; 1.9 JTD 110 Estate Car	77-81	04.99-	<b>ABS</b>	<b>KV 164</b>
<b>KF 264</b>	ABS / --> 06.98 / VIN. --> 176271 / VIN. --> 5054833 / VIN. --> 180746	2.4 TD 125 Limousine; 2.4 TD 125 Estate Car	91	09.96-04.99	ABS / --> 06.98 / VIN. --> 176271 / VIN. --> 5054833 / VIN. --> 180746	<b>KV 237</b>
<b>KF 264</b>		2.4 TD 125 Limousine; 2.4 TD 125 Estate Car	91	09.96-04.99	ABS	<b>KV 251</b>
<b>KF 264</b>	<b>ABS</b>	2.4 TD 125 Limousine; 2.4 TD 125 Estate Car	91	09.96-04.99	<b>ABS</b>	<b>KV 164</b>
<b>KF 264</b>	<b>ABS</b>	2.4 JTD Limousine; 2.4 JTD Estate Car	96	04.99-	<b>ABS</b>	<b>KV 164</b>
		2.4 JTD Limousine; 2.4 JTD Estate Car	96	04.99-	ABS	<b>KV 251</b>
<b>MULTIPLA (186)</b>						
<b>KF 283</b>	ABS	1.6 16V; 1.6 16V Bipower; 1.6 16V BLUPOwer	70-76	04.99-	ABS	<b>KV 251</b>
<b>KF 166</b>	<b>ABS</b>	1.6 16V; 1.6 16V Bipower; 1.6 16V BLUPOwer	70-76	04.99-	<b>ABS</b>	<b>KV 164</b>
<b>KF 166</b>	ABS	1.6 16V; 1.6 16V Bipower; 1.6 16V BLUPOwer	70-76	04.99-	ABS	<b>KV 251</b>
<b>KF 283</b>	ABS	1.9 JTD; 1.9 JTD 110; 1.9 JTD 115	77-85	04.99-	ABS	<b>KV 251</b>
		1.9 JTD; 1.9 JTD 110; 1.9 JTD 115	77-85	04.99-	<b>ABS</b>	<b>KV 164</b>
<b>PALIO</b>						
<b>KF 281</b>	--> 09.01	1.0; 1.1	40-56	04.96-		
		1.0; 1.1	40-56	04.96-	ABS / 09.01 -->	<b>KV 237</b>
		1.0; 1.1	40-56	04.96-	<b>ABS</b> / 09.01 -->	<b>KV 251</b>
<b>KF 281</b>	<b>ABS</b> / 09.01 -->	1.0; 1.1	40-56	04.96-		<b>KV 164</b>
		1.1	42	06.06-		<b>KV 251</b>
<b>KF 281</b>		1.1	42	06.06-		<b>KV 164</b>
		1.2	44	07.97-	ABS / 09.01 -->	<b>KV 237</b>
		1.2	44	07.97-	<b>ABS</b> / 09.01 -->	<b>KV 251</b>
		1.2	44	07.97-		<b>KV 164</b>
		1.2	50-54	04.96-02.01		<b>KV 237</b>
<b>KF 281</b>		1.2	50-54	04.96-02.01		<b>KV 164</b>
<b>KF 281</b>	<b>ABS</b> / 09.01 -->	1.2	54	06.98-		
		1.2	54	06.98-	ABS / 09.01 -->	<b>KV 237</b>
<b>KF 281</b>	<b>ABS</b> / 09.01 -->	1.2	54	06.98-	<b>ABS</b> / 09.01 -->	<b>KV 251</b>
		1.2	54	06.98-		<b>KV 164</b>
<b>KF 281</b>		1.2; 1.3; 1.4	53-70	09.01-		
		1.2; 1.3; 1.4	53-70	09.01-		<b>KV 251</b>
		1.2; 1.3; 1.4	53-70	09.01-		<b>KV 164</b>
<b>KF 281</b>	<b>ABS</b> / 09.01 -->	1.4	51	04.96-		<b>KV 164</b>
		1.4	51	04.96-	ABS / 09.01 -->	<b>KV 237</b>
		1.4 EL	51	07.97-08.01		<b>KV 237</b>
<b>KF 281</b>		1.4 EL	51	07.97-08.01		<b>KV 164</b>
		1.5	62	06.04-		<b>KV 251</b>

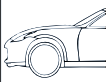
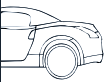
	<b>i</b>	ENGINE	POWER (kW)	YEAR	<b>i</b>	
Fersa KIT FRONT						Fersa KIT REAR
<b>FIAT</b>						
<b>PALIO</b>						
		1.5	57	04.96-06.98		<b>KV 237</b>
<b>KF 281</b>		1.5	57	04.96-06.98		<b>KV 164</b>
		1.6	68	07.97-10.03	ABS / 09.01 -->	<b>KV 237</b>
<b>KF 281</b>	ABS / 09.01 -->	1.6	68	07.97-10.03	ABS / 09.01 -->	<b>KV 251</b>
		1.6	68	07.97-10.03		<b>KV 164</b>
<b>KF 281</b>		1.6	68	07.97-10.00		<b>KV 237</b>
<b>KF 281</b>	ABS / 09.01 -->	1.6; 1.6 16V; 1.6 ED	70-74	04.96-		
		1.6; 1.6 16V; 1.6 ED	70-74	04.96-	ABS / 09.01 -->	<b>KV 237</b>
		1.6; 1.6 16V; 1.6 ED	70-74	04.96-	ABS / 09.01 -->	<b>KV 251</b>
		1.6; 1.6 16V; 1.6 ED	70-74	04.96-		<b>KV 164</b>
		1.6 16V	74	04.96-02.01		<b>KV 237</b>
<b>KF 281</b>		1.6 16V	74	04.96-02.01		<b>KV 164</b>
		1.6	74	06.06-		<b>KV 251</b>
<b>KF 281</b>		1.6	74	06.06-		<b>KV 164</b>
		1.6	74	06.06-		<b>KV 164</b>
<b>KF 281</b>	ABS / 09.01 -->	1.6 16V	76	02.01-		
		1.6 16V	76	02.01-	ABS / 09.01 -->	<b>KV 237</b>
<b>KF 281</b>	ABS / 09.01 -->	1.6 16V	76	02.01-	ABS / 09.01 -->	<b>KV 251</b>
		1.6 16V	76	02.01-		<b>KV 164</b>
		1.3 JTD Multijet	51	06.03-		<b>KV 251</b>
<b>KF 281</b>		1.3 JTD Multijet	51	06.03-		<b>KV 164</b>
		1.3 JTD Multijet	51	06.03-		<b>KV 164</b>
<b>KF 281</b>	ABS / 09.01 -->	1.7 TD; 1.7 TD ED	52-53	07.97-		
		1.7 TD; 1.7 TD ED	52-53	07.97-	ABS / 09.01 -->	<b>KV 237</b>
		1.7 TD; 1.7 TD ED	52-53	07.97-		<b>KV 164</b>
		1.7 TD HL	53	09.01-		<b>KV 251</b>
<b>KF 281</b>		1.7 TD HL	53	09.01-		<b>KV 164</b>
		1.7 TD HL	53	09.01-		<b>KV 164</b>
		1.7 TD	51	04.96-03.01		<b>KV 237</b>
<b>KF 281</b>		1.7 TD	51	04.96-03.01		<b>KV 164</b>
<b>KF 281</b>	ABS / 09.01 -->	1.9 D	46	09.00-		
		1.9 D	46	09.00-	ABS / 09.01 -->	<b>KV 237</b>
		1.9 D	46	09.00-	ABS / 09.01 -->	<b>KV 251</b>
		1.9 D	46	09.00-		<b>KV 164</b>
		1.9 JTD EL	59	09.01-		<b>KV 251</b>
<b>KF 281</b>		1.9 JTD EL	59	09.01-		<b>KV 164</b>
<b>PANDA</b>						
		750	25	01.86-12.97		<b>KV 162</b>
<b>KV 163</b>		800	25	02.81-12.85		<b>KV 204</b>
<b>KV 163</b>		900	29	04.92-12.96		<b>KV 162</b>
<b>KV 163</b>		900	33	10.80-06.94		<b>KV 204</b>
<b>KV 163</b>		950 4x4	35	09.83-12.86		
<b>KV 163</b>		1000; 1000 i.e.	32-37	01.85-02.04		<b>KV 162</b>
<b>KV 163</b>		1000 4x4	32-37	01.86-12.94		
<b>KV 163</b>		1100	37-40	05.91-09.03		<b>KV 162</b>
<b>KV 163</b>		1100 4x4	37-40	10.91-07.04		
<b>KV 163</b>		1300 D	27	04.86-12.92		<b>KV 162</b>
<b>PANDA (169)</b>						
<b>KF 288</b>		1.1; 1.2	40-44	09.03-		<b>KV 251</b>
		1.1; 1.2	40-44	09.03-		<b>KV 164</b>

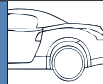
	<b>i</b>	<b>ENGINE</b>	<b>POWER (kW)</b>	<b>YEAR</b>	<b>i</b>	
Fersa KIT FRONT						Fersa KIT REAR
<b>FIAT</b>						
<b>PANDA (169)</b>						
		1.1; 1.2	40-44	09.03-		<b>KV 251</b>
<b>KF 288</b>		1.1; 1.2	40-44	09.03-		<b>KV 164</b>
<b>KF 283</b>		1.2 4x4	44	10.04-		<b>KF 288</b>
<b>KF 283</b>		1.4	74	10.06-		<b>KV 251</b>
<b>KF 283</b>		1.4	74	10.06-		<b>KV 164</b>
<b>KF 283</b>		1.3 JTD	51	09.03-		<b>KV 251</b>
		1.3 JTD	51	09.03-		<b>KV 164</b>
<b>KF 283</b>		1.3 JTD 4x4	51	10.04-		<b>KF 288</b>
<b>PUNTO (176)</b>						
<b>KF 270</b>		55 1.1 Hatchback; 55 1.1 Box Wagon	40	09.93-02.00		<b>KV 237</b>
<b>KF 270</b>		55 1.1 Hatchback; 55 1.1 Box Wagon	40	09.93-02.00		<b>KV 164</b>
		60 1.2 Hatchback; 60 1.2 Convertible; 75 1.2 Hatchback; 85 1.2 16V Hatchback; 85 1.2 16V Convertible	43-63	01.94-06.00		<b>KV 237</b>
<b>KF 165</b>		60 1.2 Hatchback; 60 1.2 Convertible; 75 1.2 Hatchback; 85 1.2 16V Hatchback; 85 1.2 16V Convertible	43-63	01.94-06.00		<b>KV 164</b>
<b>KF 166</b>		1.4 GT TURBO Hatchback	96-98	01.94-09.99		<b>KV 237</b>
<b>KF 166</b>		1.4 GT TURBO Hatchback	96-98	01.94-09.99		<b>KV 164</b>
		90 1.6 Hatchback; 90 1.6 Convertible	65	01.94-04.97		<b>KV 237</b>
<b>KF 165</b>		90 1.6 Hatchback; 90 1.6 Convertible	65	01.94-04.97		<b>KV 164</b>
		60 1.7 TD Hatchback; 1.7 D Hatchback; 1.7 D Box Wagon	42-46	04.94-02.00		<b>KV 237</b>
<b>KF 165</b>		60 1.7 TD Hatchback; 1.7 D Hatchback; 1.7 D Box Wagon	42-46	04.94-02.00		<b>KV 164</b>
<b>KF 166</b>		1.7 TD Hatchback	51-52	01.94-09.99		<b>KV 237</b>
<b>KF 166</b>		1.7 TD Hatchback	51-52	01.94-09.99		<b>KV 164</b>
<b>KF 165</b>		1.7 TD Box Wagon	52	04.96-02.00		<b>KV 237</b>
<b>KF 165</b>		1.7 TD Box Wagon	52	04.96-02.00		<b>KV 164</b>
<b>PUNTO (188)</b>						
<b>KF 346</b>		1.2 16V 80; 1.2 60; 1.2 Natural Power; 1.4; 1.8 16V 130 HGT	44-96	09.99-		<b>KV 251</b>
<b>KF 165</b>		1.2 16V 80; 1.2 60; 1.2 Natural Power; 1.4; 1.8 16V 130 HGT	44-96	09.99-		<b>KV 164</b>
		1.2 16V 80; 1.2 60; 1.2 Natural Power; 1.4; 1.8 16V 130 HGT	44-96	09.99-		<b>KV 251</b>
<b>KF 346</b>		1.2 16V 80; 1.2 60; 1.2 Natural Power; 1.4; 1.8 16V 130 HGT	44-96	09.99-		
<b>KF 166</b>		1.3 JTD 16V	51	06.03-		<b>KV 251</b>
<b>KF 283</b>		1.3 JTD 16V	51	06.03-		
<b>KF 283</b>		1.3 JTD 16V	51	06.03-		<b>KV 251</b>
<b>KF 166</b>		1.3 JTD 16V	51	06.03-		<b>KV 164</b>
<b>KF 346</b>		1.9 D 60; 1.9 DS 60	44	09.99-		<b>KV 251</b>
<b>KF 165</b>		1.9 D 60; 1.9 DS 60	44	09.99-		<b>KV 164</b>
		1.9 D 60; 1.9 DS 60	44	09.99-		<b>KV 251</b>
<b>KF 166</b>		1.9 JTD; 1.9 JTD 80	59-74	09.99-		<b>KV 251</b>
<b>KF 283</b>		1.9 JTD; 1.9 JTD 80	59-74	09.99-		<b>KV 251</b>
<b>KF 166</b>		1.9 JTD; 1.9 JTD 80	59-74	09.99-		<b>KV 164</b>
<b>REGATA</b>						
<b>KF 160</b>	--> 03.88 / CH. --> 7292150	70 1.3 Limousine	48	09.83-07.89		<b>KV 162</b>
<b>KF 160</b>		70 1.3 Limousine	50	09.83-07.86		<b>KV 162</b>
<b>KF 160</b>	--> 03.88 / CH. --> 7292150	70 1.3 i.e. Estate Car	50	01.84-07.89		<b>KV 162</b>
<b>KF 160</b>		75 1.5 Limousine	55	12.83-12.87		<b>KV 162</b>
<b>KF 160</b>	--> 03.88 / CH. --> 7292150	75 1.5 Estate Car; 75 1.5 i.e. Limousine; 75 1.5 i.e. Estate Car	55	09.84-07.89		<b>KV 162</b>
<b>KF 160</b>		85 1.5 Limousine	58	05.85-12.87		<b>KV 162</b>

	<b>i</b>	<b>ENGINE</b>	<b>POWER (kW)</b>	<b>YEAR</b>	<b>i</b>	
Fersa KIT FRONT						Fersa KIT REAR
<b>FIAT</b>						
<b>REGATA</b>						
<b>KF 160</b>		85 1.5 SUPER Limousine	60	09.83-04.85		<b>KV 162</b>
<b>KF 160</b>	--> 03.88 / CH. --> 7292150	85 1.5 Estate Car	60	01.84-04.89		<b>KV 162</b>
<b>KF 160</b>	--> 03.88 / CH. --> 7292150	85 1.6 Limousine; 100 1.6 Super Limousine; 100 i.e. 1.6 Estate Car	60-74	10.83-12.90		<b>KV 162</b>
<b>KF 160</b>		100 1.6 i.e. Estate Car	74	09.84-12.86		<b>KV 162</b>
<b>KF 160</b>	--> 03.88 / CH. --> 7292150	90 1.6 i.e. Limousine; 90 1.6 i.e. Estate Car	66	01.87-07.89		<b>KV 162</b>
<b>KF 160</b>	--> 03.88 / CH. --> 7292150	60 1.7 D Estate Car	44	01.84-12.89		<b>KV 162</b>
<b>KV 204</b>	--> 03.88 / CH. --> 7292150	60 1.7 D Limousine	44	05.85-03.89		<b>KV 162</b>
<b>KV 204</b>		60 1.7 D Limousine	43	09.83-12.86		<b>KV 162</b>
<b>KV 204</b>	--> 03.88 / CH. --> 7292150	65 1.9 D Limousine	48	04.84-07.89		<b>KV 162</b>
<b>KF 160</b>	--> 03.88 / CH. --> 7292150	65 1.9 D Estate Car; 80 1.9 TD Estate Car	48-59	04.84-07.89		<b>KV 162</b>
<b>KV 204</b>	--> 03.88 / CH. --> 7292150	80 2.0 TD Limousine	59	05.86-07.89		<b>KV 162</b>
<b>RITMO BERTONE</b>						
<b>KF 160</b>		85 1.5	60-63	01.80-07.89	<b>ABS</b>	<b>KV 162</b>
<b>RITMO I (138A)</b>						
<b>KF 160</b>		60 1.0; 65 1.3; 70 1.3; 75 1.3; 75 1.5; 75 1.5 i.e.; 85 1.5; 105 1.6 Sport	44-77	01.78-05.87	<b>ABS</b>	<b>KV 162</b>
<b>KF 160</b>		125 2.0 TC Abarth	92	11.81-09.82		
<b>KF 160</b>		55 1.7 D; 55 D 1.7	40-43	10.79-09.82	<b>ABS</b>	<b>KV 162</b>
<b>RITMO II (138A)</b>						
<b>KF 160</b>		60 1.1; 65 1.3; 75 1.5; 85 1.5; 105 1.6	40-77	10.82-12.88	<b>ABS</b>	<b>KV 162</b>
<b>KF 160</b>		125 TC Abarth 2.0; 130 TC Abarth 2.0	92-96	12.82-12.87		
<b>KF 160</b>		60 D 1.7; 80 1.9 TD	43-59	10.82-12.87	<b>ABS</b>	<b>KV 162</b>
<b>SCUDO (220)</b>						
<b>KF 113</b>		1.6; 2.0; 2.0 16V	58-100	02.96-	<b>ABS</b>	<b>KV 236</b>
<b>KF 113</b>		1.9 D; 1.9 TD; 2.0 JTD	51-80	02.96-	<b>ABS</b>	<b>KV 236</b>
<b>SEICENTO (187)</b>						
<b>KF 288</b>	<b>ABS</b>	0.9; 1.1	29-40	01.98-	<b>ABS</b>	<b>KV 162</b>
		0.9; 1.1	29-40	01.98-	<b>ABS</b>	<b>KV 162</b>
<b>SIENA</b>						
<b>KF 281</b>	--> 09.01	1.0	45	09.98-		
		1.0	45	09.98-	<b>ABS / 09.01 --&gt;</b>	<b>KV 237</b>
		1.0	45	09.98-	<b>ABS / 09.01 --&gt;</b>	<b>KV 251</b>
		1.0	45	09.98-	<b>ABS</b>	<b>KV 164</b>
		1.2	44	09.01-	<b>ABS</b>	<b>KV 251</b>
<b>KF 281</b>	<b>ABS</b>	1.2	44	09.01-	<b>ABS</b>	<b>KV 164</b>
<b>KF 281</b>	--> 09.01	1.2; 1.4	51-54	04.96-		
		1.2; 1.4	51-54	04.96-	<b>ABS / 09.01 --&gt;</b>	<b>KV 237</b>
		1.2; 1.4	51-54	04.96-	<b>ABS / 09.01 --&gt;</b>	<b>KV 251</b>
		1.2; 1.4	51-54	04.96-	<b>ABS</b>	<b>KV 164</b>
		1.5	62	06.04-	<b>ABS</b>	<b>KV 251</b>
<b>KF 281</b>	<b>ABS</b>	1.5	62	06.04-	<b>ABS</b>	<b>KV 164</b>
<b>KF 281</b>	--> 09.01	1.6; 1.6 16V	76-78	09.98-		
		1.6; 1.6 16V	76-78	09.98-	<b>ABS / 09.01 --&gt;</b>	<b>KV 237</b>
		1.6; 1.6 16V	76-78	09.98-	<b>ABS / 09.01 --&gt;</b>	<b>KV 251</b>
		1.6; 1.6 16V	76-78	09.98-	<b>ABS</b>	<b>KV 164</b>
		1.7 GL	51	02.06-	<b>ABS</b>	<b>KV 251</b>
<b>KF 281</b>	<b>ABS</b>	1.7 GL	51	02.06-	<b>ABS</b>	<b>KV 164</b>
<b>KF 281</b>	--> 09.01	1.9	46	11.00-		
		1.9	46	11.00-	<b>ABS / 09.01 --&gt;</b>	<b>KV 237</b>

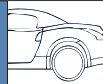

	<b>i</b>	<b>ENGINE</b>	<b>POWER (kW)</b>	<b>YEAR</b>	<b>i</b>	
Fersa KIT FRONT						Fersa KIT REAR
<b>FIAT</b>						
<b>SIENA</b>						
		1.9	46	11.00-	ABS / 09.01 -->	<b>KV 251</b>
		1.9	46	11.00-		<b>KV 164</b>
<b>STILO</b>						
<b>KF 346</b>	ABS	1.2 16V Hatchback	59	02.02-	ABS	<b>KV 251</b>
		1.4 16V Hatchback	66	03.05-	ABS	<b>KV 251</b>
		1.4 16V Hatchback	70	01.04-	ABS	<b>KV 251</b>
		1.6 16V Hatchback	76	10.01-	ABS	<b>KV 251</b>
		1.8 16V Hatchback	98	10.01-	ABS	<b>KV 251</b>
		2.4 20V Hatchback	125	10.01-	ABS	<b>KV 251</b>
		1.9 JTD Hatchback	59	02.02-	ABS	<b>KV 251</b>
		1.9 D Multijet Hatchback; 1.9 JTD (192AXS1B, 192BXS1B)	66-74	09.04-	ABS	<b>KV 251</b>
		1.9 JTD Hatchback	85	10.01-	ABS	<b>KV 251</b>
		1.9 D Multijet Hatchback	88	09.05-	ABS	<b>KV 251</b>
		1.9 JTD	93	09.03-	ABS	<b>KV 251</b>
		1.9 JTD	100	04.04-	ABS	<b>KV 251</b>
		1.9 JTD Hatchback	103	01.04-	ABS	<b>KV 251</b>
		1.9 D Multijet Hatchback	110	09.05-	ABS	<b>KV 251</b>
<b>STRADA</b>						
<b>KF 167</b>		1.2	54	06.99-		
<b>KF 167</b>		1.7 TD	51	06.99-		
<b>TALENTO (290)</b>						
<b>KA 079</b>		2.0	55	03.89-03.94		<b>KA 058</b>
<b>KA 079</b>		1.9 D	52	03.89-03.94		<b>KA 058</b>
<b>TEMPRA (159)</b>						
<b>KF 165</b>		1.4 i.e. Limousine	51	03.92-08.96	ABS	<b>KV 164</b>
		1.4 i.e. Limousine	51	03.92-08.96	ABS / --> 12.92	<b>KV 164</b>
		1.4 i.e. Limousine	51	03.92-08.96	ABS / 01.93 -->	<b>KV 218</b>
<b>KF 165</b>		1.4 i.e. Estate Car	51	10.92-08.96	ABS	<b>KV 218</b>
<b>KF 165</b>		1.4 i.e. Estate Car	51	10.92-08.96	ABS	<b>KV 164</b>
<b>KF 165</b>		1.4 i.e. Limousine; 1.4 i.e. Estate Car	57	03.91-08.96	ABS	<b>KV 164</b>
		1.4 i.e. Limousine; 1.4 i.e. Estate Car	57	03.91-08.96	ABS / --> 02.93	<b>KV 164</b>
		1.4 i.e. Limousine; 1.4 i.e. Estate Car	57	03.91-08.96	ABS / 03.93 -->	<b>KV 218</b>
		1.6 i.e. Limousine	55	06.92-08.96	ABS	<b>KV 218</b>
<b>KF 165</b>		1.6 i.e. Estate Car	55	10.92-08.96	ABS	<b>KV 164</b>
		1.6 i.e. Estate Car	55	10.92-08.96	ABS / --> 02.93	<b>KV 164</b>
		1.6 i.e. Estate Car	55	10.92-08.96	ABS / 03.93 -->	<b>KV 218</b>
<b>KF 165</b>		1.6 i.e. Limousine	57	06.90-07.92	ABS	<b>KV 164</b>
<b>KF 165</b>		1.6 i.e. S.W. Estate Car	57	10.90-08.96	ABS	<b>KV 164</b>
		1.6 i.e. S.W. Estate Car	57	10.90-08.96	ABS / 03.93 -->	<b>KV 218</b>
<b>KF 165</b>		1.6 Limousine; 1.6 Estate Car	63	03.90-04.93	ABS	<b>KV 164</b>
		1.6 Limousine; 1.6 Estate Car	63	03.90-04.93	ABS / --> 12.92	<b>KV 164</b>
		1.6 Limousine; 1.6 Estate Car	63	03.90-04.93	ABS / 01.93 -->	<b>KV 218</b>
<b>KF 165</b>		1.6 i.e. Limousine; 1.6 i.e. Estate Car	63-66	06.94-08.96	ABS	<b>KV 164</b>
<b>KF 166</b>		1.8 i.e. Limousine; 1.8 i.e. Estate Car; 2.0 i.e. Limousine; 2.0 i.e. Estate Car	66-83	03.90-08.96	ABS	<b>KV 218</b>
<b>KF 166</b>		2.0 i.e. 4x4 Estate Car	83	03.92-03.95		<b>KF 261</b>
		1.9 D Limousine; 1.9 TD Estate Car	48	07.91-08.96	ABS	<b>KV 218</b>
<b>KF 165</b>		1.9 D Limousine; 1.9 TD Estate Car	48	07.91-08.96	ABS	<b>KV 164</b>
<b>KF 166</b>		1.9 TD Limousine; 1.9 TD Estate Car	59-66	05.90-08.96	ABS	<b>KV 218</b>
<b>KF 166</b>		1.9 TD Limousine; 1.9 TD Estate Car	59-66	05.90-08.96	ABS	<b>KV 164</b>



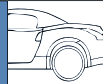

	<b>i</b>	<b>ENGINE</b>	<b>POWER (kW)</b>	<b>YEAR</b>	<b>i</b>	
Fersa KIT FRONT						Fersa KIT REAR
<b>FIAT</b>						
<b>TIPO (160)</b>						
		1.1	41	01.88-10.91		<b>KV 164</b>
		1.4 i.e.	51	05.89-04.95	<b>ABS</b>	<b>KV 164</b>
		1.4 i.e.	51	05.89-04.95	ABS / 03.93 -->	<b>KV 218</b>
		1.4	52	07.87-12.89		<b>KV 164</b>
		1.4 i.e.	57	05.89-04.95	<b>ABS</b>	<b>KV 164</b>
		1.4 i.e.	57	05.89-04.95	ABS / --> 02.93	<b>KV 164</b>
		1.4 i.e.	57	05.89-04.95	ABS / 03.93 -->	<b>KV 218</b>
<b>KF 165</b>		1.6 i.e.	55	10.92-04.95	<b>ABS</b>	<b>KV 164</b>
		1.6 i.e.	55	10.92-04.95	ABS / --> 02.93	<b>KV 164</b>
		1.6 i.e.	55	10.92-04.95	ABS / 03.93 -->	<b>KV 218</b>
<b>KF 165</b>		1.6 i.e.	57	07.90-01.93		<b>KV 164</b>
<b>KF 165</b>	--> 06.89	1.6; 1.6 i.e.	61-66	01.88-10.91		
		1.6; 1.6 i.e.	61-66	01.88-10.91	<b>ABS</b>	<b>KV 164</b>
<b>KF 166</b>		1.8 i.e.	66-76	04.93-04.95	ABS	<b>KV 218</b>
<b>KF 166</b>		1.8 i.e.	77	10.90-06.93	<b>ABS</b>	<b>KV 164</b>
<b>KF 166</b>		1.8 16V i.e.; 1.8 i.e.	81-100	11.89-06.93	ABS	<b>KV 218</b>
<b>KF 166</b>		1.8 16V i.e.; 1.8 i.e.	81-100	11.89-06.93	<b>ABS</b>	<b>KV 164</b>
<b>KF 166</b>		2.0 16V; 2.0 i.e.; 2.0 i.e. 16V SPORT	80-107	03.90-04.95	ABS	<b>KV 218</b>
<b>KF 165</b>	--> 06.89	1.7 D	43-45	01.88-10.95		
		1.7 D	43-45	01.88-10.95	ABS / --> 02.93	<b>KV 164</b>
		1.7 D	43-45	01.88-10.95	ABS / 03.93 -->	<b>KV 218</b>
<b>KF 165</b>		1.9 D	48-59	07.91-08.96	<b>ABS</b>	<b>KV 164</b>
		1.9 D	48-59	07.91-08.96	ABS / --> 02.93	<b>KV 164</b>
		1.9 D	48-59	07.91-08.96	ABS / 03.93 -->	<b>KV 218</b>
<b>KF 261</b>		1.9 TD	66	09.90-04.95	ABS	<b>KV 218</b>
<b>ULYSSE (179)</b>						
		2.0	100	08.02-		<b>KV 294</b>
<b>KA 091</b>		3.0 V6	150	08.02-		<b>KV 294</b>
		2.0 D Multijet; 2.0 JTD; 2.2 JTD	79-100	08.02-		<b>KV 294</b>
<b>KF 113</b>		1.8; 2.0; 2.0 16V; 2.0 TURBO	73-108	06.94-08.02		<b>KV 236</b>
<b>KF 113</b>		1.9 TD; 2.0 JTD; 2.1 TD	66-80	02.95-08.02		<b>KV 236</b>
<b>UNO (146A/E)</b>						
<b>KF 161</b>		45 0.9; 45 1.0; 45 1.0 i.e.; 50 1.1; 50 1.1 i.e.; 55 1.0; 55 1.1; 60 1.1; 60 1.1 (EG)	32-43	01.83-08.00	<b>ABS</b>	<b>KV 162</b>
<b>KF 160</b>		1.3 TURBO i.e.	73	01.87-12.87		
<b>KF 161</b>		70 1.3; 70 1.4 i.e.; 70 1.4 S	48-53	01.83-12.93	<b>ABS</b>	<b>KV 162</b>
<b>KF 161</b>		75 1.5 i.e.	55	10.85-12.93	<b>ABS</b>	<b>KV 162</b>
<b>KF 161</b>		1.3 D SUPER	33	06.83-03.92	<b>ABS</b>	<b>KV 162</b>
		60 1.7 D; 70 1.4 TD	42-52	10.86-12.93	<b>ABS</b>	<b>KV 162</b>
<b>KF 160</b>		60 1.7 D	44	07.86-08.89	<b>ABS</b>	<b>KV 162</b>
		1.9 D	44	09.89-03.94	<b>ABS</b>	<b>KV 162</b>
<b>X</b>						
<b>KF 161</b>	01.74 --> / --> 10.75 / CH. 1045 --> / CH. --> 6318	1.9 "EXCLUSIV SERIE"	55	05.73-12.79	01.74 --> / --> 10.75 / CH. 1045 --> / CH. --> 6318	<b>KF 161</b>

	<b>i</b>	ENGINE	POWER (kW)	YEAR	<b>i</b>	
Fersa KIT FRONT						Fersa KIT REAR
<b>FORD</b>						
<b>CAPRI I</b>						
<b>KA 016</b>		3.0	103	08.72-02.74		
<b>CAPRI II</b>						
<b>KA 016</b>		3.0	101	02.74-12.77		
<b>KA 016</b>		3.0	101	01.78-12.81		
<b>KA 075</b>	KOLN	3.0 V6	101	01.74-87		
<b>COMBI</b>						
<b>KA 019</b>		1.3,1.4,1.8 D		88-90		<b>KA 075</b>
<b>CONSUL</b>						
<b>KA 016</b>		1700; 2000; 2300; 3000	48-101	01.72-12.75		
<b>COUGAR</b>						
<b>KF 116</b>		2.0 16V; 2.5 ST 200; 2.5 V6 24V	96-151	08.98-12.01	ABS	<b>KV 221</b>
<b>KF 116</b>		2.0 16V; 2.5 ST 200; 2.5 V6 24V	96-151	08.98-12.01	<del>ABS</del>	<b>KV 220</b>
<b>ESCORT I</b>						
<b>KA 014</b>		950 Limousine	25-26	08.68-08.74		
<b>KA 014</b>		1100 Limousine; 1100 Estate Car	29	06.68-06.71		
<b>KA 014</b>	--> 11.74	1100 Limousine; 1100 Estate Car	32	01.68-02.76		
<b>KA 017</b>	12.74 -->	1100 Limousine; 1100 Estate Car	32	01.68-02.76		
<b>KA 014</b>		1100 Limousine	33	06.68-06.71		
<b>KA 014</b>	--> 11.74	1100 Limousine; 1100 Estate Car	35	06.70-02.76		
<b>KA 017</b>	12.74 -->	1100 Limousine; 1100 Estate Car	35	06.70-02.76		
<b>KA 014</b>		1300 Limousine	35-38	06.68-06.71		
<b>KA 014</b>	--> 11.74	1300 Limousine; 1300 Estate Car	40-42	06.70-02.76		
<b>KA 017</b>	12.74 -->	1300 Limousine; 1300 Estate Car	40-42	06.70-02.76		
<b>KA 014</b>		1300 GT Limousine	47	06.68-06.71		
<b>KA 014</b>	--> 11.74	1300 Limousine	53	06.70-02.76		
<b>KA 017</b>	12.74 -->	1300 Limousine	53	06.70-02.76		
<b>ESCORT II</b>						
<b>KA 017</b>		1.1 Limousine; 1.1 Estate Car; 1.3 Limousine; 1.3 Estate Car; 1.3 (BADR) Estate Car; 1.3 (CADR) Estate Car; 1.6 RS Limousine	32-62	12.74-07.81		
<b>ESCORT III</b>						
<b>KA 015</b>		1.1	37-43	09.80-12.85		<b>KA 016</b>
<b>KA 019</b>		1.3; 1.3 Cabriolet; 1.6; 1.6 RS TURBO; 1.6 XR3i; 1.6i; RS 1600i	48-97	09.80-07.86		<b>KA 016</b>
<b>KA 019</b>		1.6 D	40	02.84-12.85		<b>KA 016</b>
<b>ESCORT IV</b>						
<b>KA 015</b>		1.1; 1.3	37-51	10.85-10.90		<b>KA 016</b>
<b>KA 019</b>		1.4; 1.6; 1.6 TURBO RS; 1.6 XR3i	51-97	10.85-10.90		<b>KA 016</b>
<b>KA 019</b>		1.6 D; 1.7 D; 1.8 D	40-44	01.86-07.90		<b>KA 016</b>
<b>ESCORT V</b>						
<b>KF 115</b>		1.3; 1.4	44-52	07.90-12.92		<b>KA 021</b>
<b>KF 115</b>		1.3; 1.4	44-52	07.90-12.92		
<b>KA 020</b>	--> 12.90 / [M.T]	1.6	66-77	07.90-12.92		
<b>KF 115</b>	--> 12.90 / [A.T]	1.6	66-77	07.90-12.92		
<b>KF 115</b>	01.91 -->	1.6	66-77	07.90-12.92		
		1.6	66-77	07.90-12.92		<b>KA 021</b>
<b>KF 115</b>		1.8 16V; 1.8 16V XR3i; 2.0 16V RS	77-110	05.91-12.92		<b>KA 021</b>
<b>KF 115</b>		1.8 D	44	07.90-12.92		<b>KA 021</b>
<b>ESCORT VI</b>						
<b>KF 115</b>		1.3 Limousine; 1.3 Hatchback; 1.3 Estate Car; 1.4 Limousine; 1.4 Hatchback; 1.4 Estate Car; 1.4 Convertible; 1.4i Convertible; 1.6 16V XR3i Convertible; 1.6i 16V Limousine; 1.6i 16V Hatchback; 1.6i 16V Estate Car; 1.6i 16V Convertible; 1.8 16V XR3i Hatchback; 1.8 16V XR3i Convertible; 1.8i 16V Limousine; 1.8i 16V Hatchback; 1.8i 16V Estate Car	44-96	09.92-01.95		<b>KA 021</b>

Fersa KIT FRONT		ENGINE		POWER (kW)	YEAR	Fersa KIT REAR	
<b>FORD</b>							
<b>ESCORT VI</b>							
KF 115		1.3 Limousine; 1.3 Hatchback; 1.3 Estate Car; 1.4 Limousine; 1.4 Hatchback; 1.4 Estate Car; 1.4 Convertible; 1.4i Convertible; 1.6 16V XR3i Convertible; 1.6i 16V Limousine; 1.6i 16V Hatchback; 1.6i 16V Estate Car; 1.6i 16V Convertible; 1.8 16V XR3i Hatchback; 1.8 16V XR3i Convertible; 1.8i 16V Limousine; 1.8i 16V Hatchback; 1.8i 16V Estate Car		44-96	09.92-01.95		
KA 020		1.8 XR3i 16V 4x4 Hatchback		77-96	08.93-01.95		KA 020
		RS Cosworth 4x4 Hatchback		162	09.92-01.95	LEFT WHEEL	KA 347
		RS Cosworth 4x4 Hatchback		162	09.92-01.95	RIGHT WHEEL	KA 257
KF 115		RS 2000 Hatchback		110	09.92-01.95		KA 021
KA 020		RS 2000 16V 4x4 Hatchback		110	08.93-01.95		KA 020
KF 115		1.8 D Limousine; 1.8 D Hatchback; 1.8 D Estate Car; 1.8 TD Limousine; 1.8 TD Hatchback; 1.8 TD Estate Car		44-66	09.92-01.95		KA 021
<b>ESCORT VII</b>							
KF 115		1.3; 1.4; 1.6 16V; 1.6 16V XR3i; 1.6i 16V		44-66	01.95-09.99		KA 021
KA 020		1.6 16V 4x4		66	01.95-10.98		KA 020
KF 115		1.8 16V; 1.8 16V XR3i		77-96	01.95-08.00		KA 021
KF 115		RS COSWORTH 4x4		162	02.95-10.98		KA 021
KF 115		RS 2000		110	02.95-02.98		KA 021
KA 020		RS 2000 4x4		110	02.95-10.98		KA 020
KF 115		1.8 D; 1.8 TD		44-66	01.95-08.99		KA 021
<b>ESCORT CLASSIC</b>							
KF 115		1.6 16V		66	10.98-07.00		KA 021
KF 115		1.8 TD		66	10.98-07.00		KA 021
<b>ESCORT '81 EXPRESS (AVA)</b>							
KA 019		1.1; 1.3; 1.6		37-61	03.81-02.86		KA 083
KA 019		1.6 D		40	02.84-02.86		KA 083
KA 019		1.1; 1.3; 1.4i; 1.6		37-60	02.86-07.90		KA 083
KA 019		1.6 D; 1.7 D		40-44	02.86-07.90		KA 083
<b>ESCORT '91 EXPRESS (AVL)</b>							
KF 115		1.3; 1.4		46-52	07.90-12.94		
KF 115		1.8 D		44	07.90-12.94		
KF 115		1.4		54	01.95-		
KF 115		1.8 D		44-51	01.95-		
<b>FIESTA I</b>							
KA 074		1.0, 1.1		29	77-80		KA 014
KA 015		1.0 Bus		29	10.77-11.86		KA 014
KA 015		0.9		29-33	05.76-08.83		KA 014
KA 015		1.1		39	05.76-08.83		KA 014
KA 015		1.1		40	02.81-08.83		KA 014
KA 019	01.81 -->	1.3		49	08.77-08.83	01.81 -->	KA 014
KA 019		1.6 XR2		62	08.81-08.83		KA 014
<b>FIESTA II</b>							
KA 015		1.0 Bus		33	08.83-11.89		KA 014
KA 015		1.0 (FBD)		33	09.83-02.89		KA 014
KA 015		1.0; 1.1		33-37	09.83-11.89		KA 014
KA 019		1.3		51	09.83-01.87		KA 014
KA 020	--> 01.94	1.3 Courier		44	09.91-02.96		
KF 115	02.94 -->	1.3 Courier		44	09.91-02.96		
		1.3 Courier		44	09.91-02.96	ABS / 01.95 -->	KV 221
		1.3 Courier		44	09.91-02.96	ABS / 01.95 -->	KV 220
KF 115		1.3 Courier		44	02.96-	ABS	KV 221

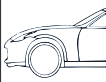
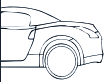
	<b>i</b>	<b>ENGINE</b>	<b>POWER (kW)</b>	<b>YEAR</b>	<b>i</b>	
Fersa KIT FRONT						Fersa KIT REAR
<b>FORD</b>						
<b>FIESTA II</b>						
<b>KF 115</b>		1.3 Courier	44	02.96-	<del>ABS</del>	<b>KV 220</b>
<b>KF 115</b>		1.4i Courier	66	04.96-10.99	ABS	<b>KV 221</b>
		1.4i Courier	66	04.96-10.99	<del>ABS</del>	<b>KV 220</b>
		1.4i Courier	66	04.96-10.99	ABS	<b>KV 221</b>
<b>KF 115</b>		1.4i Courier	66	04.96-10.99	<del>ABS</del>	<b>KV 220</b>
<b>KA 019</b>		1.4; 1.6 XR2	52-71	03.84-11.89		<b>KA 014</b>
<b>KA 019</b>		1.6 D	40	04.84-02.89		<b>KA 014</b>
<b>KA 020</b>	--> 01.94	1.8 D Bus; 1.8 D Courier	43-44	03.89-02.96		
<b>KF 115</b>	02.94 -->	1.8 D Bus; 1.8 D Courier	43-44	03.89-02.96		
		1.8 D Bus; 1.8 D Courier	43-44	03.89-02.96	ABS / 01.95 -->	<b>KV 221</b>
		1.8 D Bus; 1.8 D Courier	43-44	03.89-02.96	<del>ABS</del> / 01.95 -->	<b>KV 220</b>
<b>KF 115</b>		1.8 D Courier; 1.8 DI Courier	44-55	02.96-		
		1.8 D Courier; 1.8 DI Courier	44-55	02.96-	ABS	<b>KV 221</b>
		1.8 D Courier; 1.8 DI Courier	44-55	02.96-	<del>ABS</del>	<b>KV 220</b>
<b>FIESTA III</b>						
<b>KA 020</b>	--> 01.94	1.0; 1.1; 1.3	33-44	03.89-12.95		
<b>KF 115</b>	02.94 -->	1.0; 1.1; 1.3	33-44	03.89-12.95		
		1.0; 1.1; 1.3	33-44	03.89-12.95		<b>KA 021</b>
<b>KA 020</b>		1.3	44	03.89-12.92		<b>KA 021</b>
<b>KA 020</b>	--> 01.94	1.4	52-54	03.89-12.95		
<b>KF 115</b>	02.94 -->	1.4	52-54	03.89-12.95		
		1.4	52-54	03.89-12.95		<b>KA 021</b>
<b>KF 115</b>		1.6i 16V	65	01.94-12.95		<b>KA 021</b>
<b>KA 020</b>		1.6; 1.6 TURBO; 1.6 XR2i	65-96	01.89-01.94		<b>KA 021</b>
<b>KA 020</b>	--> 01.94	1.8 16V; 1.8 XR2i 16V	77-96	02.92-12.95		
<b>KF 115</b>	02.94 -->	1.8 16V; 1.8 XR2i 16V	77-96	02.92-12.95		
		1.8 16V; 1.8 XR2i 16V	77-96	02.92-12.95		<b>KA 021</b>
<b>KA 020</b>	--> 01.94	1.8 D	44	03.89-12.95		
<b>KF 115</b>	02.94 -->	1.8 D	44	03.89-12.95		
		1.8 D	44	03.89-12.95		<b>KA 021</b>
<b>KF 115</b>		1.8 D Bus	44	05.98-		<b>KA 021</b>
<b>KA 020</b>	--> 01.94	1.8 TD	57	03.93-12.95		
<b>KF 115</b>	02.94 -->	1.8 TD	57	03.93-12.95		
		1.8 TD	57	03.93-12.95		<b>KA 021</b>
<b>FIESTA IV</b>						
<b>KF 115</b>		1.0i; 1.25i 16V; 1.3i; 1.4i 16V; 1.6 16V	37-76	08.95-01.02		<b>KA 021</b>
<b>KF 115</b>		1.8 D; 1.8 DI	44-55	08.95-01.02		<b>KA 021</b>
<b>FIESTA V</b>						
<b>KF 282</b>	ABS	1.3; 1.3 16V; 1.4i 16V; 1.6 16V; ST150	44-110	11.01-		<b>KB 191</b>
<b>KF 201</b>	<del>ABS</del>	1.3; 1.3 16V; 1.4i 16V; 1.6 16V; ST150	44-110	11.01-		<b>KB 191</b>
<b>KF 282</b>	ABS	1.4 TDCi; 1.6 TDCi	50-66	11.01-		<b>KB 191</b>
<b>KF 201</b>	<del>ABS</del>	1.4 TDCi; 1.6 TDCi	50-66	11.01-		<b>KB 191</b>
<b>KF 282</b>	ABS	1.4; 1.4 16V; 1.6 16V; 1.8 16V; 2.0 16V; ST170	55-127	10.98-11.04		<b>KB 191</b>
<b>KF 201</b>	<del>ABS</del>	1.4; 1.4 16V; 1.6 16V; 1.8 16V; 2.0 16V; ST170	55-127	10.98-11.04		<b>KB 191</b>
<b>KF 282</b>	ABS	1.8 DI/TDDi; 1.8 TDCi; 1.8 TURBO DI/TDDi	55-85	10.98-11.04		<b>KB 191</b>
<b>KF 201</b>	<del>ABS</del>	1.8 DI/TDDi; 1.8 TDCi; 1.8 TURBO DI/TDDi	55-85	10.98-11.04		<b>KB 191</b>
<b>FOCUS C-MAX</b>						
<b>KV 322</b>		1.6; 1.6 Ti; 1.8; 2.0	74-107	10.03-03.07		
<b>KV 322</b>		1.8 FFV	92	01.06-03.07		
<b>KV 322</b>		1.6 TDCi; 1.8 TDCi; 2.0 TDCi	66-100	10.03-03.07		

	<b>i</b>	<b>ENGINE</b>	<b>POWER (kW)</b>	<b>YEAR</b>	<b>i</b>	
Fersa KIT FRONT						Fersa KIT REAR
<b>FORD</b>						
<b>FOCUS C-MAX</b>						
<b>KV 322</b>		1.4; 1.6; 1.6 Ti; 2.0	59-107	11.04-		
<b>KV 322</b>		1.6 TDCi; 2.0 TDCi	66-100	11.04-		
<b>KF 282</b>	ABS	1.4; 1.6	59-74	08.02-		<b>KB 191</b>
<b>KF 201</b>	ABS	1.4; 1.6	59-74	08.02-		<b>KB 191</b>
<b>KF 282</b>	ABS	1.4 TDCi	50	08.02-		<b>KB 191</b>
<b>KF 201</b>	ABS	1.4 TDCi	50	08.02-		<b>KB 191</b>
<b>GALAXY (WGR)</b>						
<b>KF 240</b>		2.0i; 2.3 16V	85-107	11.95-		<b>KF 241</b>
<b>KF 240</b>		2.3 4x4	107	09.96-04.00		<b>KF 240</b>
<b>KF 240</b>		2.8i V6 4x4	128	04.96-04.00		<b>KF 240</b>
<b>KF 240</b>		2.8 V6; 2.8i V6	128-150	11.95-		<b>KF 241</b>
<b>KF 240</b>		1.9 TDI	66-110	03.95-		<b>KF 241</b>
<b>GRA (GG_)</b>						
<b>KA 016</b>		1.7; 2.0; 2.3; 2.5; 2.6; 2.9; 3.0	48-101	01.72-08.77		
<b>KA 016</b>		1.6; 1.7; 2.0; 2.3; 2.8; 2.8i	51-118	08.77-08.85		
<b>KA 016</b>		1.9 D; 2.1 D; 2.5 D	40-51	08.77-08.85		
<b>GRANADA</b>						
<b>KA 075</b>		1.6,1.7,1.8;2.0,2.1D,2.3	51-118	72-04.85		
<b>KA 075</b>		2.5 D	51-118	77-04.85		
<b>KA 075</b>		2.8 V6	51-118	72-04.85		
<b>KA</b>						
<b>KF 115</b>		1.0i; 1.3i	36-48	09.96-		<b>KA 021</b>
<b>KF 115</b>		1.3i; 1.6	51-70	08.02-		<b>KA 021</b>
<b>MONDEO I</b>						
<b>KF 116</b>		1.6i 16V Limousine; 1.6i 16V Hatchback	65	07.94-08.96	ABS	<b>KV 221</b>
<b>KF 116</b>		1.6i 16V Limousine; 1.6i 16V Hatchback	65	07.94-08.96	ABS	<b>KV 220</b>
<b>KF 116</b>		1.6i 16V Estate Car	65	07.94-08.96		<b>KV 222</b>
<b>KF 116</b>		1.6i 16V Limousine; 1.6i 16V Hatchback	66	02.93-08.96	ABS	<b>KV 221</b>
<b>KF 116</b>		1.6i 16V Limousine; 1.6i 16V Hatchback	66	02.93-08.96	ABS	<b>KV 220</b>
<b>KF 116</b>		1.6i 16V Estate Car	66	04.93-08.96		<b>KV 222</b>
<b>KF 116</b>		1.8i 16V Limousine; 1.8i 16V Hatchback	82	01.94-08.96	ABS	<b>KV 221</b>
<b>KF 116</b>		1.8i 16V Limousine; 1.8i 16V Hatchback	82	01.94-08.96	ABS	<b>KV 220</b>
<b>KF 116</b>		1.8i 16V Estate Car	82	07.94-08.96		<b>KV 222</b>
<b>KF 116</b>		1.8i 16V Limousine; 1.8i 16V Hatchback	85	02.93-08.96	ABS	<b>KV 221</b>
<b>KF 116</b>		1.8i 16V Limousine; 1.8i 16V Hatchback	85	02.93-08.96	ABS	<b>KV 220</b>
<b>KF 116</b>		1.8i 16V 4x4 Hatchback	85	02.93-08.96		
<b>KF 116</b>		1.8i 16V Estate Car	85	04.93-08.96		<b>KV 222</b>
<b>KF 116</b>		1.8i 16V 4x4 Estate Car	85	04.93-08.96		
<b>KF 116</b>		2.0i 16V Estate Car	97	01.93-08.96		<b>KV 222</b>
<b>KF 116</b>		2.0i 16V Hatchback	97	12.94-08.96	ABS	<b>KV 221</b>
<b>KF 116</b>		2.0i 16V Hatchback	97	12.94-08.96	ABS	<b>KV 220</b>
<b>KF 116</b>		2.0i 16V 4x4 Estate Car	97	12.94-08.96		
<b>KF 116</b>		2.0i 16V 4x4 Limousine; 2.0i 16V 4x4 Hatchback	97	12.94-08.96		
<b>KF 116</b>		2.0i 16V Limousine; 2.0i 16V Hatchback	100	02.93-08.96	ABS	<b>KV 221</b>
<b>KF 116</b>		2.0i 16V Limousine; 2.0i 16V Hatchback	100	02.93-08.96	ABS	<b>KV 220</b>
<b>KF 116</b>		2.0i 16V Estate Car	100	04.93-08.96		<b>KV 222</b>
<b>KF 116</b>		2.0i 16V 4x4 Estate Car	100	04.93-08.96		
<b>KF 116</b>		2.5i 24V Limousine; 2.5i 24V Hatchback	125	07.94-08.96	ABS	<b>KV 221</b>
<b>KF 116</b>		2.5i 24V Limousine; 2.5i 24V Hatchback	125	07.94-08.96	ABS	<b>KV 220</b>
<b>KF 116</b>		2.5i 24V Estate Car	125	07.94-08.96		<b>KV 222</b>

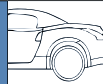
	<b>i</b>	<b>ENGINE</b>	<b>POWER (kW)</b>	<b>YEAR</b>	<b>i</b>	
Fersa KIT FRONT						Fersa KIT REAR
<b>FORD</b>						
<b>MONDEO I</b>						
<b>KF 116</b>		1.8 TD Limousine; 1.8 TD Hatchback	65	06.93-08.96	ABS	<b>KV 221</b>
<b>KF 116</b>		1.8 TD Limousine; 1.8 TD Hatchback	65	06.93-08.96	<del>ABS</del>	<b>KV 220</b>
<b>KF 116</b>		1.8 TD Estate Car	65	06.93-08.96		<b>KV 222</b>
<b>KF 116</b>		1.8 TD Limousine; 1.8 TD Hatchback	66	10.95-08.96	ABS	<b>KV 221</b>
<b>KF 116</b>		1.8 TD Limousine; 1.8 TD Hatchback	66	10.95-08.96	<del>ABS</del>	<b>KV 220</b>
<b>KF 116</b>		1.8 TD Estate Car	66	11.95-08.96		<b>KV 222</b>
<b>MONDEO II</b>						
<b>KF 116</b>		1.6i Limousine; 1.6i Hatchback	66	09.96-11.00	ABS	<b>KV 221</b>
<b>KF 116</b>		1.6i Limousine; 1.6i Hatchback	66	09.96-11.00	<del>ABS</del>	<b>KV 220</b>
<b>KF 116</b>		1.6i Estate Car	66	09.96-11.00	--> 12.97	<b>KV 222</b>
<b>KF 116</b>		1.6i Estate Car	66	09.96-11.00	ABS / 12.97 -->	<b>KV 221</b>
<b>KF 116</b>		1.6i Limousine; 1.6i Hatchback	70	05.98-11.00	ABS	<b>KV 221</b>
<b>KF 116</b>		1.6i Limousine; 1.6i Hatchback	70	05.98-11.00	<del>ABS</del>	<b>KV 220</b>
<b>KF 116</b>		1.6i Estate Car	70	05.98-11.00	ABS	<b>KV 221</b>
<b>KF 116</b>		1.8i Limousine; 1.8i Hatchback	85	09.96-11.00	ABS	<b>KV 221</b>
<b>KF 116</b>		1.8i Limousine; 1.8i Hatchback	85	09.96-11.00	<del>ABS</del>	<b>KV 220</b>
<b>KF 116</b>		1.8i Estate Car	85	09.96-11.00	--> 12.97	<b>KV 222</b>
<b>KF 116</b>		1.8i Estate Car	85	09.96-11.00	ABS / 12.97 -->	<b>KV 221</b>
<b>KF 116</b>		2.0i Limousine; 2.0i Hatchback	96	09.96-11.00	ABS	<b>KV 221</b>
<b>KF 116</b>		2.0i Limousine; 2.0i Hatchback	96	09.96-11.00	<del>ABS</del>	<b>KV 220</b>
<b>KF 116</b>		2.0i Estate Car	96	09.96-11.00	--> 12.97	<b>KV 222</b>
<b>KF 116</b>		2.0i Estate Car	96	09.96-11.00	ABS / 12.97 -->	<b>KV 221</b>
<b>KF 116</b>		2.5 24V Limousine; 2.5 24V Hatchback	125	06.00-11.00	ABS	<b>KV 221</b>
<b>KF 116</b>		2.5 24V Limousine; 2.5 24V Hatchback	125	06.00-11.00	<del>ABS</del>	<b>KV 220</b>
<b>KF 116</b>		2.5 24V Estate Car	125	06.00-11.00		<b>KV 222</b>
<b>KF 116</b>		ST 200 Limousine; ST 200 Hatchback	151	05.99-11.00	ABS	<b>KV 221</b>
<b>KF 116</b>		ST 200 Limousine; ST 200 Hatchback	151	05.99-11.00	<del>ABS</del>	<b>KV 220</b>
<b>KF 116</b>		ST 200 Estate Car	151	05.99-11.00	ABS	<b>KV 221</b>
<b>KF 116</b>		2.5 24V Limousine; 2.5 24V Hatchback	125	09.96-11.00	ABS	<b>KV 221</b>
<b>KF 116</b>		2.5 24V Limousine; 2.5 24V Hatchback	125	09.96-11.00	<del>ABS</del>	<b>KV 220</b>
<b>KF 116</b>		2.5 24V Estate Car	125	09.96-11.00	--> 12.97	<b>KV 222</b>
<b>KF 116</b>		2.5 24V Estate Car	125	09.96-11.00	ABS / 12.97 -->	<b>KV 221</b>
<b>KF 116</b>		1.8 TD Limousine; 1.8 TD Hatchback	66	09.96-11.00	ABS	<b>KV 221</b>
<b>KF 116</b>		1.8 TD Limousine; 1.8 TD Hatchback	66	09.96-11.00	<del>ABS</del>	<b>KV 220</b>
		1.8 TD Estate Car	66	09.96-11.00	--> 12.97	<b>KV 222</b>
		1.8 TD Estate Car	66	09.96-11.00	ABS / 12.97 -->	<b>KV 221</b>
<b>MONDEO III</b>						
<b>KF 329</b>		1.8 16V; 1.8 SCi; 2.0 16V; 2.5 V6 24V; 3.0 V6 24V; ST220	81-166	11.00-		<b>KV 328</b>
<b>KF 329</b>	[M.T]	2.0 16V DI / TDDi; 2.0 TDCi	66-96	11.00-		
		2.0 16V DI / TDDi; 2.0 TDCi	66-96	11.00-		<b>KV 328</b>
<b>KF 329</b>		2.2 TDCi	114	09.04-		<b>KV 328</b>
<b>ORION I</b>						
<b>KA 019</b>		1.3; 1.6; 1.6i	51-77	07.83-03.86		<b>KA 016</b>
<b>KA 019</b>		1.6 D	40	02.84-03.86		<b>KA 016</b>
<b>ORION II</b>						
<b>KA 019</b>		1.3; 1.4; 1.6; 1.6i	44-77	12.85-07.90		<b>KA 016</b>
<b>KA 019</b>		1.6 D; 1.7 D	40-44	12.85-07.90		<b>KA 016</b>
<b>ORION III</b>						
<b>KA 020</b>	--> 09.91	1.3; 1.4	44-52	07.90-12.93		

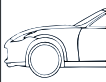
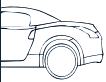

	<b>i</b>	<b>ENGINE</b>	<b>POWER (kW)</b>	<b>YEAR</b>	<b>i</b>	
Fersa KIT FRONT						Fersa KIT REAR
<b>FORD</b>						
<b>ORION III</b>						
<b>KF 115</b>	10.91 -->	1.3; 1.4	44-52	07.90-12.93		
		1.3; 1.4	44-52	07.90-12.93		<b>KA 021</b>
<b>KF 115</b>	ABS / --> 09.91 / [M.T]	1.4	54	07.90-12.93		
<b>KF 115</b>	--> 09.91 / [A.T]	1.4	54	07.90-12.93		
<b>KF 115</b>	10.91 -->	1.4	54	07.90-12.93		
<b>KA 020</b>	ABS / --> 09.91 / [M.T]	1.4	54	07.90-12.93		
		1.4	54	07.90-12.93		<b>KA 021</b>
<b>KF 115</b>		1.6i 16V	66	07.92-12.93		<b>KA 021</b>
<b>KF 115</b>	ABS / --> 09.91 / [M.T]	1.6	66	07.90-12.92		<b>KA 021</b>
<b>KF 115</b>	--> 09.91 / [A.T]	1.6	66	07.90-12.92		<b>KA 021</b>
<b>KF 115</b>	10.91 -->	1.6	66	07.90-12.92		<b>KA 021</b>
<b>KA 020</b>	ABS / --> 09.91 / [M.T]	1.6	66	07.90-12.92		<b>KA 021</b>
<b>KF 115</b>		1.6i 16V; 1.8i 16V	77	07.90-12.93		<b>KA 021</b>
<b>KA 019</b>		1.8i 16V	96	01.92-12.93		<b>KA 016</b>
<b>KF 115</b>		1.8 D; 1.8 TD	44-66	11.90-12.93		<b>KA 021</b>
<b>P 100 I</b>						
<b>KA 075</b>		1.6	54-73	04.82-88		
<b>KA 016</b>		1.6	54	04.82-09.87		
<b>P 100 II</b>						
<b>KA 018</b>	LEFT WHEEL	2.0	57	10.87-		
<b>KA 018</b>	LEFT WHEEL	1.8 TD	55	10.87-12.92		
<b>PUMA (EC )</b>						
<b>KF 115</b>		1.4 16V; 1.6 16V; 1.7 16V; ST 160	66-118	03.97-		<b>KA 021</b>
<b>SAPPHIRE</b>						
<b>KA 081</b>	<b>ABS</b>	1.6,1.6i,1.8,1.8i		09.83-93		<b>KA 082</b>
<b>KA 081</b>	<b>ABS</b>	1.8 TD		02.90-93		<b>KA 082</b>
<b>KA 081</b>	<b>ABS</b>	2.0,2.0i,2.3		09.83-93		<b>KA 082</b>
<b>KA 081</b>	<b>ABS</b>	2.3 D		09.83-90		<b>KA 082</b>
<b>SCORPIO I</b>						
		1.8 Hatchback; 2.0 Hatchback; 2.0i Hatchback	66-85	04.85-02.92	LEFT WHEEL	<b>KA 347</b>
		1.8 Hatchback; 2.0 Hatchback; 2.0i Hatchback	66-85	04.85-02.92	RIGHT WHEEL	<b>KA 257</b>
		2.0i Hatchback	85	02.92-09.94	LEFT WHEEL	<b>KA 347</b>
		2.0i Hatchback	85	02.92-09.94	RIGHT WHEEL	<b>KA 257</b>
		2.0 Hatchback	80	11.88-10.92	LEFT WHEEL	<b>KA 347</b>
		2.0 Hatchback	80	11.88-10.92	RIGHT WHEEL	<b>KA 257</b>
		2.0i Limousine; 2.0i Estate Car	85	09.91-09.94	LEFT WHEEL	<b>KA 347</b>
		2.0i Limousine; 2.0i Estate Car	85	09.91-09.94	RIGHT WHEEL	<b>KA 257</b>
		2.0i Turnier Estate Car	88	09.91-09.94	LEFT WHEEL	<b>KA 347</b>
		2.0i Turnier Estate Car	88	09.91-09.94	RIGHT WHEEL	<b>KA 257</b>
		2.0i Limousine	92	05.89-02.92	LEFT WHEEL	<b>KA 347</b>
		2.0i Limousine	92	05.89-02.92	RIGHT WHEEL	<b>KA 257</b>
		2.4i Limousine	92	10.88-10.94	LEFT WHEEL	<b>KA 347</b>
		2.4i Limousine	92	10.88-10.94	RIGHT WHEEL	<b>KA 257</b>
		2.4i Hatchback	92	10.88-02.92	LEFT WHEEL	<b>KA 347</b>
		2.4i Hatchback	92	10.88-02.92	RIGHT WHEEL	<b>KA 257</b>
		2.4i Hatchback	92	10.88-09.94	LEFT WHEEL	<b>KA 347</b>
		2.4i Hatchback	92	10.88-09.94	RIGHT WHEEL	<b>KA 257</b>
		2.4i Estate Car	92	09.91-09.94	LEFT WHEEL	<b>KA 347</b>
		2.4i Estate Car	92	09.91-09.94	RIGHT WHEEL	<b>KA 257</b>
		2.4i Hatchback; 2.8i Hatchback	96-110	04.85-09.88	LEFT WHEEL	<b>KA 347</b>

	<b>i</b>	<b>ENGINE</b>	<b>POWER (kW)</b>	<b>YEAR</b>	<b>i</b>	
Fersa KIT FRONT						Fersa KIT REAR
<b>FORD</b>						
<b>SCORPIO I</b>						
		2.4i Hatchback; 2.8i Hatchback	96-110	04.85-09.88	RIGHT WHEEL	<b>KA 257</b>
		2.8i 4x4 Hatchback	110	10.85-11.86	LEFT WHEEL	<b>KA 347</b>
		2.8i 4x4 Hatchback	110	10.85-11.86	RIGHT WHEEL	<b>KA 257</b>
		2.9i Limousine; 2.9i Hatchback	107	09.86-12.94	LEFT WHEEL	<b>KA 347</b>
		2.9i Limousine; 2.9i Hatchback	107	09.86-12.94	RIGHT WHEEL	<b>KA 257</b>
		2.9i Estate Car	107	09.91-09.94	LEFT WHEEL	<b>KA 347</b>
		2.9i Estate Car	107	09.91-09.94	RIGHT WHEEL	<b>KA 257</b>
		2.9i Hatchback	107-110	09.86-09.94	LEFT WHEEL	<b>KA 347</b>
		2.9i Hatchback	107-110	09.86-09.94	RIGHT WHEEL	<b>KA 257</b>
		2.9i 4x4 Limousine; 2.9i 4x4 Hatchback; 2.9i 4x4 Estate Car	107-110	09.86-10.94	LEFT WHEEL	<b>KA 347</b>
		2.9i 4x4 Limousine; 2.9i 4x4 Hatchback; 2.9i 4x4 Estate Car	107-110	09.86-10.94	RIGHT WHEEL	<b>KA 257</b>
		2.9i 24V Limousine; 2.9i 24V Hatchback	143	04.91-09.94	LEFT WHEEL	<b>KA 347</b>
		2.9i 24V Limousine; 2.9i 24V Hatchback	143	04.91-09.94	RIGHT WHEEL	<b>KA 257</b>
		2.9 24V Estate Car	143	08.93-09.94	LEFT WHEEL	<b>KA 347</b>
		2.9 24V Estate Car	143	08.93-09.94	RIGHT WHEEL	<b>KA 257</b>
		2.5 D Hatchback	51	12.85-02.92	LEFT WHEEL	<b>KA 347</b>
		2.5 D Hatchback	51	12.85-02.92	RIGHT WHEEL	<b>KA 257</b>
		2.5 D Limousine	51	12.89-12.94	LEFT WHEEL	<b>KA 347</b>
		2.5 D Limousine	51	12.89-12.94	RIGHT WHEEL	<b>KA 257</b>
		2.5 TD Limousine; 2.5 TD Hatchback	68	06.88-07.93	LEFT WHEEL	<b>KA 347</b>
		2.5 TD Limousine; 2.5 TD Hatchback	68	06.88-07.93	RIGHT WHEEL	<b>KA 257</b>
		2.5 TD Limousine; 2.5 TD Hatchback; 2.5 TD Estate Car	68-85	09.91-09.94	LEFT WHEEL	<b>KA 347</b>
		2.5 TD Limousine; 2.5 TD Hatchback; 2.5 TD Estate Car	68-85	09.91-09.94	RIGHT WHEEL	<b>KA 257</b>
<b>SCORPIO II</b>						
		2.0i; 2.0i 16V; 2.3i 16V; 2.9i	85-110	10.94-08.98	LEFT WHEEL / --> 04.97	<b>KA 347</b>
		2.0i; 2.0i 16V; 2.3i 16V; 2.9i	85-110	10.94-08.98	RIGHT WHEEL / --> 04.97	<b>KA 257</b>
		2.9i	110	02.95-08.98	LEFT WHEEL / --> 04.97	<b>KA 347</b>
		2.9i	110	02.95-08.98	RIGHT WHEEL / --> 04.97	<b>KA 257</b>
		2.9i 24V	152	10.94-08.98	LEFT WHEEL / --> 04.97	<b>KA 347</b>
		2.9i 24V	152	10.94-08.98	RIGHT WHEEL / --> 04.97	<b>KA 257</b>
		2.5 TD	85-92	10.94-08.98	LEFT WHEEL / --> 04.97	<b>KA 347</b>
		2.5 TD	85-92	10.94-08.98	RIGHT WHEEL / --> 04.97	<b>KA 257</b>
<b>SIERRA (C)</b>						
<b>KA 018</b>	LEFT WHEEL	1.3; 1.6	44-55	08.82-12.86		
<b>KA 081</b>	RIGHT WHEEL	1.3; 1.6	44-55	08.82-12.86		
		1.3; 1.6	44-55	08.82-12.86	LEFT WHEEL / 09.83 -->	<b>KA 076</b>
<b>KA 081</b>	<b>ABS</b>	1.3	44-55	09.83-93		<b>KA 082</b>
<b>KA 081</b>	<b>ABS</b>	1.6	44-55	09.83-93		<b>KA 082</b>
<b>KA 081</b>	<b>ABS</b>	1.8,1.8i	44-55	09.83-93		<b>KA 082</b>
<b>KA 018</b>	LEFT WHEEL	1.6; 1.8; 2.0	58-74	08.84-12.86	LEFT WHEEL	<b>KA 076</b>
<b>KA 081</b>	RIGHT WHEEL	1.6; 1.8; 2.0	58-74	08.84-12.86	LEFT WHEEL	<b>KA 076</b>
		1.6; 1.8; 2.0	58-74	08.84-12.86	LEFT WHEEL	<b>KA 076</b>
<b>KA 081</b>	<b>ABS</b>	1.8 TD	58-74	90-93		<b>KA 082</b>
<b>KA 018</b>	LEFT WHEEL	2.0	77	08.82-12.86		
<b>KA 081</b>	RIGHT WHEEL	2.0	77	08.82-12.86		
		2.0	77	08.82-12.86	LEFT WHEEL / 09.83 -->	<b>KA 076</b>
<b>KA 018</b>	LEFT WHEEL	2.0; 2.0i	85	03.85-12.86	LEFT WHEEL	<b>KA 076</b>
<b>KA 081</b>	RIGHT WHEEL	2.0; 2.0i	85	03.85-12.86	LEFT WHEEL	<b>KA 076</b>
		2.0; 2.0i	85	03.85-12.86	LEFT WHEEL	<b>KA 076</b>
<b>KA 018</b>	LEFT WHEEL	2.0; 2.3	66-84	08.82-12.86		

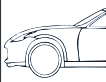
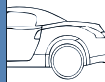
	<b>i</b>	<b>ENGINE</b>	<b>POWER (kW)</b>	<b>YEAR</b>	<b>i</b>	
Fersa KIT FRONT						Fersa KIT REAR
<b>FORD</b>						
<b>SIERRA (C)</b>						
<b>KA 081</b>	RIGHT WHEEL	2.0; 2.3	66-84	08.82-12.86		
		2.0; 2.3	66-84	08.82-12.86	LEFT WHEEL / 09.83 -->	<b>KA 076</b>
<b>KA 081</b>	<b>ABS</b>	2.0,2.0i,2.3,2.3 V6	66-84	09.83-93		<b>KA 082</b>
<b>KA 081</b>	<b>ABS</b>	2.3 D	66-84	09.83-90		<b>KA 082</b>
<b>KA 081</b>	<b>ABS</b>	2.8,2.9 V6	66-84	09.83-93		<b>KA 082</b>
		2.8i 4x4	105-107	08.82-12.86	LEFT WHEEL / 09.83 -->	<b>KA 347</b>
		2.8i 4x4	105-107	08.82-12.86	RIGHT WHEEL / 09.83 -->	<b>KA 257</b>
<b>KA 018</b>	LEFT WHEEL	2.8 XR4i	105-110	08.82-12.86		
<b>KA 081</b>	RIGHT WHEEL	2.8 XR4i	105-110	08.82-12.86		
		2.8 XR4i	105-110	08.82-12.86	LEFT WHEEL / 09.83 -->	<b>KA 347</b>
		2.8 XR4i	105-110	08.82-12.86	ABS / RIGHT WHEEL / 09.83 -->	<b>KA 257</b>
		2.8 XR4i	105-110	08.82-12.86	ABS / LEFT WHEEL / 09.83 -->	<b>KA 076</b>
		2.8 XR 4x4; 2.8i XR 4x4 Hatchback	107-110	09.83-12.86		<b>KA 347</b>
		2.8 XR 4x4; 2.8i XR 4x4 Hatchback	107-110	09.83-12.86		<b>KA 257</b>
<b>KA 081</b>	<b>ABS</b>	XR4i 2.8,2.9 V6	107-110	10.83-93		<b>KA 082</b>
<b>KA 018</b>	LEFT WHEEL	2.3 D	49	08.82-12.86		
<b>KA 081</b>	RIGHT WHEEL	2.3 D	49	08.82-12.86		
		2.3 D	49	08.82-12.86	RIGHT WHEEL / 09.83 -->	<b>KA 076</b>
<b>SIERRA (G)</b>						
<b>KA 018</b>	LEFT WHEEL	1.6 Limousine; 1.6 Hatchback; 1.6 Estate Car; 1.6i Limousine; 1.6i Hatchback; 1.8 Limousine; 1.8 Hatchback; 1.8 Estate Car; 2.0 Limousine; 2.0 Hatchback; 2.0 Estate Car; 2.0i Limousine; 2.0i Hatchback; 2.0i Estate Car	53-85	01.87-02.93		
<b>KA 081</b>	RIGHT WHEEL	1.6 Limousine; 1.6 Hatchback; 1.6 Estate Car; 1.6i Limousine; 1.6i Hatchback; 1.8 Limousine; 1.8 Hatchback; 1.8 Estate Car; 2.0 Limousine; 2.0 Hatchback; 2.0 Estate Car; 2.0i Limousine; 2.0i Hatchback; 2.0i Estate Car	53-85	01.87-02.93		
		1.6 Limousine; 1.6 Hatchback; 1.6 Estate Car; 1.6i Limousine; 1.6i Hatchback; 1.8 Limousine; 1.8 Hatchback; 1.8 Estate Car; 2.0 Limousine; 2.0 Hatchback; 2.0 Estate Car; 2.0i Limousine; 2.0i Hatchback; 2.0i Estate Car	53-85	01.87-02.93	LEFT WHEEL / ABS	<b>KA 347</b>
		1.6 Limousine; 1.6 Hatchback; 1.6 Estate Car; 1.6i Limousine; 1.6i Hatchback; 1.8 Limousine; 1.8 Hatchback; 1.8 Estate Car; 2.0 Limousine; 2.0 Hatchback; 2.0 Estate Car; 2.0i Limousine; 2.0i Hatchback; 2.0i Estate Car	53-85	01.87-02.93	RIGHT WHEEL / ABS	<b>KA 257</b>
		1.6 Limousine; 1.6 Hatchback; 1.6 Estate Car; 1.6i Limousine; 1.6i Hatchback; 1.8 Limousine; 1.8 Hatchback; 1.8 Estate Car; 2.0 Limousine; 2.0 Hatchback; 2.0 Estate Car; 2.0i Limousine; 2.0i Hatchback; 2.0i Estate Car	53-85	01.87-02.93	LEFT WHEEL / ABS	<b>KA 076</b>
		2.0 RS COSWORTH Hatchback	150	11.87-01.90	LEFT WHEEL	<b>KA 347</b>
		2.0 RS COSWORTH Hatchback	150	11.87-01.90	RIGHT WHEEL	<b>KA 257</b>
		2.0 16V COSWORTH 4x4 Hatchback	162	01.90-02.93	LEFT WHEEL	<b>KA 347</b>
		2.0 16V COSWORTH 4x4 Hatchback	162	01.90-02.93	RIGHT WHEEL	<b>KA 257</b>
<b>KA 018</b>	LEFT WHEEL	2.0i Limousine; 2.0i Hatchback; 2.0i Estate Car	80-92	05.89-02.93		
<b>KA 081</b>	RIGHT WHEEL	2.0i Limousine; 2.0i Hatchback; 2.0i Estate Car	80-92	05.89-02.93		
		2.0i Limousine; 2.0i Hatchback; 2.0i Estate Car	80-92	05.89-02.93	LEFT WHEEL / ABS	<b>KA 347</b>
		2.0i Limousine; 2.0i Hatchback; 2.0i Estate Car	80-92	05.89-02.93	RIGHT WHEEL / ABS	<b>KA 257</b>
		2.0i Limousine; 2.0i Hatchback; 2.0i Estate Car	80-92	05.89-02.93	LEFT WHEEL / ABS	<b>KA 076</b>
		2.0 4x4 Limousine; 2.0 4x4 Estate Car; 2.0 XR 4x4 Limousine	88-92	05.89-02.93	LEFT WHEEL	<b>KA 347</b>
		2.0 4x4 Limousine; 2.0 4x4 Estate Car; 2.0 XR 4x4 Limousine	88-92	05.89-02.93	RIGHT WHEEL	<b>KA 257</b>
<b>KA 018</b>	LEFT WHEEL	2.8i Limousine; 2.8i Hatchback; 2.8i Estate Car	105-107	01.87-02.93		
<b>KA 081</b>	RIGHT WHEEL	2.8i Limousine; 2.8i Hatchback; 2.8i Estate Car	105-107	01.87-02.93		
		2.8i Limousine; 2.8i Hatchback; 2.8i Estate Car	105-107	01.87-02.93	LEFT WHEEL	<b>KA 347</b>
		2.8i Limousine; 2.8i Hatchback; 2.8i Estate Car	105-107	01.87-02.93	RIGHT WHEEL	<b>KA 257</b>

		<b>i</b>	<b>ENGINE</b>	<b>POWER (kW)</b>	<b>YEAR</b>	<b>i</b>	
<b>Fersa KIT FRONT</b>							<b>Fersa KIT REAR</b>
<b>FORD</b>							
<b>SIERRA (G)</b>							
			2.8 4x4 Estate Car; 2.8i 4x4 Estate Car; 2.8i XR 4x4 Hatchback	107-110	01.87-02.93	LEFT WHEEL	<b>KA 347</b>
			2.8 4x4 Estate Car; 2.8i 4x4 Estate Car; 2.8i XR 4x4 Hatchback	107-110	01.87-02.93	RIGHT WHEEL	<b>KA 257</b>
<b>KA 018</b>	LEFT WHEEL		2.9i Limousine; 2.9i Estate Car	107-110	08.88-02.93		
<b>KA 081</b>	RIGHT WHEEL		2.9i Limousine; 2.9i Estate Car	107-110	08.88-02.93		
			2.9i Limousine; 2.9i Estate Car	107-110	08.88-02.93	LEFT WHEEL	<b>KA 347</b>
			2.9i Limousine; 2.9i Estate Car	107-110	08.88-02.93	RIGHT WHEEL	<b>KA 257</b>
			2.9 4x4 Limousine; 2.9 4x4 Estate Car	107-110	08.88-02.93	LEFT WHEEL	<b>KA 347</b>
			2.9 4x4 Limousine; 2.9 4x4 Estate Car	107-110	08.88-02.93	RIGHT WHEEL	<b>KA 257</b>
<b>KA 018</b>	LEFT WHEEL		2.9 Estate Car; 2.9i Hatchback	107	08.88-02.93		
<b>KA 081</b>	RIGHT WHEEL		2.9 Estate Car; 2.9i Hatchback	107	08.88-02.93		
			2.9 Estate Car; 2.9i Hatchback	107	08.88-02.93	LEFT WHEEL	<b>KA 347</b>
			2.9 Estate Car; 2.9i Hatchback	107	08.88-02.93	RIGHT WHEEL	<b>KA 257</b>
			2.9 4x4 Estate Car; 2.9i XR 4x4 Hatchback	107-110	08.88-02.93	LEFT WHEEL	<b>KA 347</b>
			2.9 4x4 Estate Car; 2.9i XR 4x4 Hatchback	107-110	08.88-02.93	RIGHT WHEEL	<b>KA 257</b>
<b>KA 018</b>	LEFT WHEEL		1.8 TD Limousine; 1.8 TD Hatchback; 1.8 TD Estate Car; 2.3 D Limousine; 2.3 D Hatchback	49-55	01.87-02.93		
<b>KA 081</b>	RIGHT WHEEL		1.8 TD Limousine; 1.8 TD Hatchback; 1.8 TD Estate Car; 2.3 D Limousine; 2.3 D Hatchback	49-55	01.87-02.93		
			1.8 TD Limousine; 1.8 TD Hatchback; 1.8 TD Estate Car; 2.3 D Limousine; 2.3 D Hatchback	49-55	01.87-02.93	LEFT WHEEL / ABS	<b>KA 347</b>
			1.8 TD Limousine; 1.8 TD Hatchback; 1.8 TD Estate Car; 2.3 D Limousine; 2.3 D Hatchback	49-55	01.87-02.93	RIGHT WHEEL / ABS	<b>KA 257</b>
			1.8 TD Limousine; 1.8 TD Hatchback; 1.8 TD Estate Car; 2.3 D Limousine; 2.3 D Hatchback	49-55	01.87-02.93	LEFT WHEEL / ABS	<b>KA 076</b>
<b>KA 018</b>	LEFT WHEEL		2.3 D Estate Car	49	01.87-02.93		
<b>KA 081</b>	RIGHT WHEEL		2.3 D Estate Car	49	01.87-02.93		
			2.3 D Estate Car	49	01.87-02.93	LEFT WHEEL	<b>KA 347</b>
			2.3 D Estate Car	49	01.87-02.93	RIGHT WHEEL	<b>KA 257</b>
<b>KF 115</b>			1.6	70	05.03-07.05		<b>KA 021</b>
<b>TAUNUS (GBCK,GBFK,GBNK,GBTK)</b>							
<b>KA 017</b>			1300 Limousine	40	08.70-02.76		
<b>KA 017</b>			1300 Estate Car	40	08.70-02.76		
<b>KA 017</b>			1300 Limousine; 1300 Coupe	40	01.70-02.76		
<b>KA 017</b>			1600 Estate Car	53	08.70-02.76		
<b>KA 017</b>			1600 Limousine; 1600 Coupe	50-65	08.70-02.76		
<b>KA 017</b>			1600 Estate Car	50	01.74-05.75		
<b>KA 017</b>			1600 Limousine	53	01.70-02.76		
<b>KA 017</b>			2000 V6 Limousine; 2000 V6 Coupe; 2300 V6 Coupe	66-79	08.70-02.76		
<b>KA 017</b>			1.3 (CBTS) Limousine	40	09.76-07.79		
<b>KA 017</b>			1.3 Limousine	40	05.75-07.79		
<b>KA 017</b>			1.3 Estate Car	40	12.75-07.79		
<b>KA 017</b>			1.3 Estate Car	43	05.75-07.79		
<b>KA 017</b>			1.6 Limousine	50	05.75-07.79		
<b>KA 017</b>			1.6 Estate Car	50	05.75-07.79		
<b>KA 017</b>			1.6 Limousine	53	05.75-07.79		
<b>KA 017</b>			1.6 Estate Car; 2.0 Limousine; 2.0 Estate Car; 2.3 Limousine; 2.3 Estate Car	53-79	05.75-07.79		
<b>TAUNUS '80 (GBS,GBNS)</b>							
<b>KA 017</b>			1.3 Limousine; 1.6 Limousine	43-51	07.79-07.82		
<b>KA 017</b>			1.6 Estate Car	51	07.79-07.82		

 Fersa KIT FRONT	<b>i</b>	ENGINE	POWER (kW)	YEAR	<b>i</b>	Fersa KIT REAR
<b>FORD</b>						
<b>TAUNUS '80 (GBS,GBNS)</b>						
KA 017		1.6 Limousine	54	07.79-07.82		
KA 017		1.6 Estate Car; 2.0 Limousine; 2.0 Estate Car; 2.3 Limousine; 2.3 Estate Car	54-84	07.79-07.82		
<b>TRANSIT (72E,71E)</b>						
KA 083		1.5; 1.7 FT 100	44-48	01.71-03.78		KD 117
KA 083		1.5 1000; 1.5 1100; 1.5 900; 1.7; 1.7 1000; 1.7 1300; 1.7 900; 1.7 FT 100	44-48	11.65-03.78		KD 117
KA 083		2.3 FT 100	46	11.71-09.78		KD 117
<b>TRANSIT (74E)</b>						
KA 083		1.5; 1.7 FT 100	44-48	01.71-03.78		KD 117
<b>TRANSIT (81E)</b>						
KA 083		1,7 13	48	11.65-07.73		KD 117
<b>TRANSIT (E_ _)</b>						
KA 085		2.0 Bus; 2.0 Bus; 2.0 Platform; 2.0 CNG Bus; 2.0i Bus; 2.0i Bus; 2.9i Bus	66-107	01.91-		KB 263
KA 085		2.0 Bus; 2.0 Bus; 2.0 Platform; 2.0 CNG Bus; 2.0i Bus; 2.0i Bus; 2.9i Bus	66-107	01.91-		KA 084
KA 085		2.5 DI Bus; 2.5 DI Bus; 2.5 DI Platform; 2.5 TD Bus; 2.5 TD Bus; 2.5 TD Platform; 2.5 TDI Bus	51-85	05.91-06.00		KB 263
KA 085		2.5 DI Bus; 2.5 DI Bus; 2.5 DI Platform; 2.5 TD Bus; 2.5 TD Bus; 2.5 TD Platform; 2.5 TDI Bus	51-85	05.91-06.00		KA 084
<b>TRANSIT (FA_Y)</b>						
KV 291		2.3 16V	107	04.01-		KA 084
KV 291		2.0 DI; 2.0 TDCi	55-92	08.00-		KV 326
KV 291		2.0 DI; 2.0 TDCi	55-92	08.00-	--> 06.03	KV 326
KV 291		2.0 DI; 2.0 TDCi	55-92	08.00-	ABS / 07.03 -->	KV 324
KV 291		2.0 DI; 2.0 TDCi	55-92	08.00-	ABS / 07.03 -->	KV 323
KV 291		2.4 DI	55-66	01.00-		KA 084
KV 291		2.4 TDE	85	03.04-		KA 084
KV 291		2.4 DI	88	01.00-		KA 084
KV 291		2.4 TDCi; 2.4 TDE	92-101	07.01-		KA 084
<b>TRANSIT (FDBY,FDCY,FSBY,FSCY)</b>						
KV 291		2.3 16V	107	08.00-		KA 084
KV 291		2.0 DI; 2.0 TDCi	55-92	08.00-		KV 326
KV 291		2.0 DI; 2.0 TDCi	55-92	08.00-	--> 06.03	KV 326
KV 291		2.0 DI; 2.0 TDCi	55-92	08.00-	ABS / 07.03 -->	KV 324
KV 291		2.0 DI; 2.0 TDCi	55-92	08.00-	ABS / 07.03 -->	KV 323
KV 291		2.4 DI	55-66	01.00-		KA 084
KV 291		2.4 TDE	85	03.04-		KA 084
KV 291		2.4 DI; 2.4 TDE	88-92	01.00-		KA 084
KV 291		2.4 TDCi	101	03.04-		KA 084
<b>TRANSIT (FM_Y,FN_Y)</b>						
KV 291		2.3 16V	107	04.01-		KA 084
KV 291		2.0 DI; 2.0 TDCi	55-92	08.00-		KV 326
KV 291		2.0 DI; 2.0 TDCi	55-92	08.00-	--> 06.03	KV 326
KV 291		2.0 DI; 2.0 TDCi	55-92	08.00-	ABS / 07.03 -->	KV 324
KV 291		2.0 DI; 2.0 TDCi	55-92	08.00-	ABS / 07.03 -->	KV 323
KV 291		2.4 DI	55-88	01.00-		KA 084
<b>TRANSIT (T_ _)</b>						
KA 083		1.6 Bus	46	09.85-09.92		KD 117
		1.6 Bus	46	09.85-09.92		KA 084
KA 083		1.6 Bus	46	12.85-01.89		KD 117

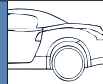
	<b>i</b>	<b>ENGINE</b>	<b>POWER (kW)</b>	<b>YEAR</b>	<b>i</b>	
Fersa KIT FRONT						Fersa KIT REAR
<b>FORD</b>						
<b>TRANSIT (T_...)</b>						
KA 083		1.6 Bus	46	12.85-01.89		KA 084
KA 083		1.6 Bus	46	12.85-01.89		
KA 083		2.0 Platform	57	11.85-09.92		KD 117
KA 083		2.0 Platform	57	11.85-09.92		KA 084
KA 083		2.0 Bus	57	12.85-09.92		KD 117
KA 083		2.0 Bus	57	12.85-09.92		KA 084
KA 083		2.0 Bus	57	09.85-09.92		KD 117
KA 083		2.0 Bus	57	09.85-09.92		KA 084
KA 083		2.0 Bus	57	11.85-09.92		KD 117
KA 083		2.0 Bus	57	11.85-09.92		KA 084
KA 083		2.0 Platform	57	01.86-09.92		KD 117
KA 083		2.0 Platform	57	01.86-09.92		KA 084
KA 083		2.5 D Bus; 2.5 D Bus	50	12.85-09.91		KD 117
KA 083		2.5 D Bus; 2.5 D Bus	50	12.85-09.91		KA 084
KA 083		2.5 D Platform	50	01.86-01.89		KD 117
KA 083		2.5 D Platform	50	01.86-01.89		KA 084
KA 083		2.5 D Bus	52	09.88-09.92		KD 117
KA 083		2.5 D Bus	52	09.88-09.92		KA 084
KA 083		2.5 DI Platform	52	09.88-09.92		KD 117
KA 083		2.5 DI Platform	52	09.88-09.92		KA 084
KA 083		2.5 D Bus	52	10.88-09.91		KD 117
KA 083		2.5 D Bus	52	10.88-09.91		KA 084
<b>TRANSIT (V_...)</b>						
KA 083		1.6 Bus; 1.6 Bus; 1.6 Platform; 2.0 Bus; 2.0 Bus; 2.0 Platform	43-57	11.77-10.86		KD 117
KA 083		2.4 D Bus; 2.4 D Bus; 2.4 D Platform; 2.5 D Bus; 2.5 D Bus; 2.5 D Platform	46-50	11.77-10.86		KD 117
KA 083		80-120	46	11.85-91		KD 118
<b>FSO</b>						
<b>125P</b>						
KA 056		1.3; 1.5	47-55	10.67-08.92	--> 12.73	KC 253
KA 056		1.3; 1.5	47-55	10.67-08.92	01.74 -->	KC 205
KA 213	01.88 --> / --> 12.90	0.6	22	07.77-12.91	01.88 --> / --> 12.90	KA 210
<b>POLONEZ I</b>						
KA 056	01.79 -->	1.5	55	10.77-08.88	01.79 -->	KC 205
KA 056		1.6	64	08.86-08.88		KC 205
<b>POLONEZ II</b>						
KA 056	--> 12.90	1.5; 1.5i; 1.6	55-64	08.88-08.92	--> 12.90	KC 205
KA 056	--> 12.90	1.9 D	51	08.88-08.92	--> 12.90	KC 205
<b>HONDA</b>						
<b>ACCORD III (CA4,CA5)</b>						
KF 099		1.6 L; 1.6 L (CA4); 2.0 EX (CA5); 2.0 EXi (CA5)	65-85	11.85-12.89	ABS	KV 260
KF 099		2.0 EXi (CA5)	90	11.85-12.87	ABS	KV 260
KF 099		2.0i 16V (CA5)	98	10.87-12.89	ABS	KV 260
KF 099		2.0i 16V (CA5)	101	01.87-12.87	ABS	KV 260
<b>ACCORD IV (CB3,CB7,CB8,CC,CC1)</b>						
KV 229	ABS	2.0 16V (CB3) Limousine; 2.0i 16V (CB3) Limousine	66-98	01.90-03.93		

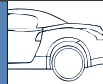

	<b>i</b>	<b>ENGINE</b>	<b>POWER (kW)</b>	<b>YEAR</b>	<b>i</b>	
Fersa KIT FRONT						Fersa KIT REAR
<b>HONDA</b>						
<b>ACCORD IV (CB3,CB7,CB8,CC,CC1)</b>						
<b>KV 229</b>	<b>ABS</b>	2.0i 16V Coupe	98	01.92-09.93		
<b>KV 229</b>	<b>ABS</b>	2.0i 16V (CC9) Estate Car	98	03.93-12.93		
<b>KV 229</b>	<b>ABS</b>	2.2i 16V (CB7) Limousine	108	01.90-03.93		
<b>KV 229</b>	<b>ABS</b>	2.2i 16V (CB8) Estate Car	108	01.91-12.93		
<b>KV 229</b>	<b>ABS</b>	2.2i 16V (CB7) Limousine	110	01.90-03.93		
<b>KV 229</b>	<b>ABS</b>	2.2i 16V (CB8) Estate Car	110	01.91-12.93		
<b>ACCORD V (CC7,CD7,CE)</b>						
<b>KV 229</b>	<b>ABS</b>	2.0i; 2.0i S	85-96	03.93-01.96		
<b>KV 229</b>	<b>ABS</b>	2.3i SR	116	03.93-01.96		
<b>CIVIC I SHUTTLE</b>						
<b>KF 320</b>		1.5 (AN)	63	10.83-10.87	01.85 --> / CH. OS100001 -->	<b>KV 100</b>
<b>KF 320</b>		1.5 (AR) 4WD	63	01.85-10.87		
<b>CIVIC II</b>						
<b>KF 320</b>		1.2 (AL) Hatchback	40	01.84-10.87		
<b>KF 320</b>	CH. --> OS100001	1.2 Limousine	40	01.85-10.87	CH. OS100001 --> / DRUM BRAKE	<b>KV 100</b>
<b>KF 320</b>		1.3 Limousine	52	10.83-10.87	CH. OS100001 --> / DRUM BRAKE	<b>KV 100</b>
<b>KF 320</b>		1.3 (AG) Hatchback	52	10.83-10.87		
<b>KF 320</b>		1.5 GL Limousine	63	10.83-10.87	CH. OS100001 --> / DRUM BRAKE	<b>KV 100</b>
<b>KF 320</b>		1.5 GL (AH) Hatchback	63	10.83-10.87		
<b>KF 320</b>	CH. --> OS100001	1.5 GTI Limousine	66	03.86-10.87	CH. OS100001 --> / DRUM BRAKE	<b>KV 100</b>
<b>KF 320</b>	CH. --> OS100001	1.5 GT Limousine	74	01.85-10.87	CH. OS100001 --> / DRUM BRAKE	<b>KV 100</b>
<b>KF 320</b>		1.5 GT (AH) Hatchback	74	01.85-10.87		<b>KV 100</b>
<b>CIVIC II SHUTTLE</b>						
<b>KF 320</b>	--> 12.89	1.5i 16V	69	01.88-11.91	--> 12.89	<b>KV 260</b>
<b>KF 320</b>		1.6i 16V	80-81	01.88-02.95		
<b>CIVIC III</b>						
<b>KF 320</b>		1.3 (EC8); 1.3 16V (EC8); 1.4 L (EC9)	55-66	10.87-09.91		<b>KV 100</b>
<b>KF 320</b>		1.4 L (ED2)	66	10.87-12.89		<b>KV 100</b>
<b>KF 320</b>	--> 12.89	1.5i 16V (ED3); 1.5i 16V (ED6); 1.6i 16V (ED4); 1.6i 16V (ED7)	69-81	10.87-09.91		<b>KV 100</b>
<b>KF 320</b>		1.6i 16V 4x4	80	10.89-09.91		
<b>KF 320</b>	--> 12.89	1.6i 16V; 1.6i 16V (ED)	96	09.87-09.91		
<b>KF 320</b>		1.6i 16V VTEC (EE9)	110	10.89-09.91		<b>KV 100</b>
<b>CIVIC IV</b>						
<b>KF 304</b>		1.3 16V (EG3) Hatchback	55	10.91-11.95		<b>KV 100</b>
<b>KF 102</b>	--> 12.96	1.4i (MA8) Hatchback	55	09.95-01.97		
<b>KF 102</b>	01.95 --> / --> 12.96	1.4i (MA8) Hatchback; 1.5i VTEC-E (MA9) Hatchback	66	09.94-01.97		
<b>KF 304</b>		1.5i 16V (EG4) Hatchback	69	10.91-11.95		<b>KV 100</b>
<b>KF 304</b>	01.93 -->	1.5i 16V (EG8) Limousine	69	10.91-11.95	<b>ABS</b> / DRUM BRAKE	<b>KV 100</b>
<b>KF 304</b>		1.5i LSi (EJ2) Coupe	74	01.94-11.95		
		1.5i LSi (EJ2) Coupe	74	01.94-11.95	<b>ABS</b>	<b>KV 100</b>
<b>KF 102</b>	01.95 --> / --> 12.96	1.6i (MB1) Hatchback	83	09.94-01.97		
<b>KF 102</b>	ABS / 01.94 -->	1.6 16V VTEC (EG5) Hatchback; 1.6 16V VTEC (EH9) Limousine	92	10.91-11.95	01.94 --> / DISC BRAKE	<b>KV 100</b>
<b>KF 304</b>	01.92 -->	1.6 16V VTEC (EG5) Hatchback; 1.6 16V VTEC (EH9) Limousine	92	10.91-11.95	01.94 --> / DISC BRAKE	<b>KV 100</b>
<b>KF 102</b>		1.6i VTEC (EJ1) Coupe	92	01.94-03.96	<b>ABS</b> / --> 12.94	<b>KV 100</b>
<b>KF 304</b>		1.6i VTEC (EJ1) Coupe	92	01.94-03.96	<b>ABS</b> / --> 12.94	<b>KV 100</b>
		1.6i VTEC (EJ1) Coupe	92	01.94-03.96	<b>ABS</b> / --> 12.94	<b>KV 100</b>
<b>KF 102</b>	01.95 --> / --> 12.96	1.6i VTEC (MB1) Hatchback	93	09.94-01.97		
<b>KF 102</b>		1.6 VTi (EG9) Limousine	118	10.91-11.95		

	<b>i</b>	ENGINE	POWER (kW)	YEAR	<b>i</b>	
Fersa KIT FRONT						Fersa KIT REAR
<b>HONDA</b>						
<b>CIVIC II SHUTTLE</b>						
<b>KF 304</b>	01.92	1.6 VTi 16V (EG6) Hatchback	118	10.91-11.95		
<b>CIVIC V</b>						
<b>KF 304</b>	01.96 --> / --> 12.96	1.4i (EJ9) Hatchback	55	11.95-02.01		
<b>KF 304</b>	ABS / 01.96 --> / --> 12.96	1.4i (EJ9) Hatchback	55	11.95-02.01	ABS / 01.96 --> / --> 12.96	<b>KV 100</b>
<b>KF 102</b>		1.4 16V (MB2) Hatchback	55	01.97-02.01		
<b>KF 304</b>	01.96 --> / --> 12.96	1.4i (EJ9) Limousine; 1.4i S (EJ9) Hatchback	66	11.95-02.01	ABS / 01.96 --> / --> 12.96 / DRUM BRAKE	<b>KV 100</b>
<b>KF 102</b>		1.4 16V (MB2) Hatchback	66	01.97-02.01		
<b>KF 102</b>		1.5i (EK3) Limousine; 1.5i (EK3) Hatchback	84	11.95-02.01	ABS / DRUM BRAKE	<b>KV 100</b>
<b>KF 102</b>		1.5 16V (MB3) Hatchback	84	01.97-02.01		
<b>KF 102</b>		1.6i (EK1) Limousine	84	11.95-02.01	ABS / DRUM BRAKE	<b>KV 100</b>
<b>KF 102</b>		1.6 16V (MB4) Hatchback	85	01.97-02.01		
<b>KF 102</b>		1.6 VTi (EK4) Limousine; 1.6 VTi (EK4) Hatchback; 1.6i Vtec Hatchback; 1.8 16V (MB6) Hatchback	92-124	11.95-02.01	ABS / DRUM BRAKE	<b>KV 100</b>
<b>CRX I (AF,AS)</b>						
<b>KF 320</b>		1.5i (AF); 1.6i (AS)	74-92	10.83-10.87		<b>KV 100</b>
<b>CRX II (ED,EE)</b>						
<b>KF 320</b>		1.6i 16V (ED9)	91-96	10.87-02.92		<b>KV 100</b>
		1.6i 16V VTEC (EE8)	110	10.89-02.92		<b>KV 100</b>
<b>CRX III (EH,EG)</b>						
<b>KF 102</b>		1.6 ESi (EH6); 1.6i VTi (EG2)	92-118	03.92-12.98		
		1.6 ESi (EH6); 1.6i VTi (EG2)	92-118	03.92-12.98	--> 12.96 / DRUM BRAKE	<b>KV 100</b>
<b>HR-V</b>						
<b>KF 102</b>		1.6 16V; 1.6 16V 4WD	77-91	03.99-		
<b>PRELUDE III (BA)</b>						
<b>KF 099</b>		2.0i EX 16V	101	04.86-12.87		
<b>KF 099</b>		2.0i EX 16V (BA)	101	04.86-12.87		
<b>HYUNDAI</b>						
<b>ACCENT (LC)</b>						
<b>KF 299</b>		1.3; 1.5; 1.6	55-77	09.99-		
<b>KF 299</b>		1.5 CRDi	60	01.02-		
<b>ACCENT (MC)</b>						
<b>KF 299</b>		1.4 GL; 1.6 GLS	71-82	11.05-		
<b>KF 299</b>		1.5 CRDi GLS	81	11.05-		
<b>ACCENT (X-3)</b>						
<b>KA 022</b>	--> 12.99	1.3; 1.3i 12V; 1.5i 12V; 1.5i 16V	44-73	10.94-01.00		
		1.3; 1.3i 12V; 1.5i 12V; 1.5i 16V	44-73	10.94-01.00	ABS / --> 12.95	<b>KV 231</b>
		1.3; 1.3i 12V; 1.5i 12V; 1.5i 16V	44-73	10.94-01.00	ABS / --> 12.95	<b>KV 230</b>
<b>KF 299</b>		1.4 GL; 1.6 GLS	71-82	11.05-		
<b>KF 299</b>		1.5 CRDi GLS	81	11.05-		
<b>ATOS (MX)</b>						
<b>KF 299</b>		0.8; 1.0i; 1.1	38-46	02.98-		
<b>COUPE (RD)</b>						
<b>KF 299</b>		1.6 16V; 1.6i 16V; 2.0i	84-102	08.96-04.02		
<b>EXCEL/PONY (X-2)</b>						
<b>KA 022</b>	--> 12.93	1.5i	61	01.90-01.95		
<b>H100</b>						
<b>KA 023</b>		2.4	82-90	07.93-		

	<b>i</b>	ENGINE	POWER (kW)	YEAR	<b>i</b>	
Fersa KIT FRONT						Fersa KIT REAR
<b>HYUNDAI</b>						
<b>H100</b>						
<b>KA 023</b>		2.5 D; 2.5 TD; 2.6	55-59	07.93-		
<b>H100 PICK-UP</b>						
<b>KA 023</b>		2.5 D	57	05.96-10.01		
<b>LANTRA I (J-1)</b>						
<b>KA 022</b>		1.5 i.e. 16V; 1.6 i.e. 16V; 1.8 i.e. 16V	63-93	10.90-11.95		
<b>LANTRA II (J-2)</b>						
<b>KF 299</b>		1.5 12V Limousine; 1.5 12V Estate Car	65	12.96-		
<b>KA 022</b>	--> 12.95	1.6i Limousine	66	11.95-09.00		
<b>KF 299</b>	01.96 -->	1.6i Limousine	66	11.95-09.00		
<b>KF 299</b>		1.6i Estate Car	66	02.96-		
<b>KA 022</b>	--> 12.95	1.6 Limousine	84	11.95-09.00		
<b>KF 299</b>	01.96 -->	1.6 Limousine	84	11.95-09.00		
<b>KF 299</b>		1.6 16V Estate Car	84	02.96-		
<b>KA 022</b>	--> 12.95	1.8 16V Limousine	94	11.95-09.00		
<b>KF 299</b>	01.96 -->	1.8 16V Limousine	94	11.95-09.00		
<b>KF 299</b>		1.8 16V Estate Car; 2.0 16V	94-102	02.96-		
<b>KF 299</b>		1.9 D	50	03.98-		
<b>PONY (X-2)</b>						
<b>KA 086</b>		1.5	53	10.85-09.89		
<b>KA 022</b>		1.3; 1.5; 1.5i	43-62	10.89-01.95		<b>KA 086</b>
<b>S COUPE (SLC)</b>						
<b>KA 022</b>		1.5i; 1.5i TURBO	62-85	02.90-05.96		
<b>SONATA II (Y-3)</b>						
		2.0i; 2.0i 16V; 3.0i V6	70-107	05.93-06.98	ABS	<b>KV 336</b>
<b>IVECO</b>						
<b>DAILY I</b>						
<b>KA 169</b>	06.79 --> / AXT:Iveco	30-8 [9]	53	01.78-12.89	AXT:Iveco	<b>KA 170</b>
<b>KA 169</b>	AXT:Iveco	30-8 [9]	55-60	01.92-08.98	AXT:Iveco	<b>KA 170</b>
<b>KA 169</b>	06.79 --> / AXT:Iveco	30-8 V [8]; 30-8 C [8]; 35-8 [9]	53	01.78-12.89	AXT:Iveco	<b>KA 170</b>
<b>KA 171</b>		Daily 30-8 (1) Salisbury IVECO	53	06.81-09.84		<b>KA 170</b>
<b>KA 169</b>	--> 02.96 / AXT:Iveco	35-8 [9]	55-60	01.89-08.98	--> 02.96, AXT:Iveco	<b>KA 170</b>
<b>KA 169</b>		35-10 [9]	68-76	01.85-12.96	AXT:Iveco	<b>KA 170</b>
		35-12 [9]	85	01.90-04.96		<b>KA 170</b>
		35-12 [9]	90	05.96-	--> 12.99, AXT:Iveco	<b>KA 170</b>
<b>KA 169</b>	AXT:Iveco	40-8 [9]	53	01.83-06.89	AXT:Iveco	<b>KA 170</b>
		45-10 [9]	68-76	01.85-04.96	AXT:5.602.1	<b>KA 170</b>
<b>GRINTA</b>						
<b>KA 171</b>		30-8 (1) Salisbury	53	06.81-09.84		<b>KA 170</b>
<b>KIA</b>						
<b>CARENS I</b>						
<b>KF 225</b>		1.8; 2.0 GSX	81-100	11.00-07.02		
<b>CARENS II</b>						
<b>KF 225</b>		1.6; 1.8; 2.0	77-102	07.02-		
<b>KF 225</b>		2.0 CRDi	83-103	07.02-		
<b>CLARUS (GC, K9A)</b>						
<b>KF 225</b>		1.8i 16V Limousine; 1.8i 16V Estate Car; 2.0i 16V	85-98	07.96-		

	<b>i</b>	<b>ENGINE</b>	<b>POWER (kW)</b>	<b>YEAR</b>	<b>i</b>	
Fersa KIT FRONT						Fersa KIT REAR
<b>KIA</b>						
<b>RIO II</b>						
<b>KF 299</b>		1.4 16V; 1.6 16V	71-82	03.05-		
<b>KF 299</b>		1.5; 1.5 CRDi	81	03.05-		
<b>SEPHIA (FA)</b>						
<b>KF 227</b>		1.5i Hatchback; 1.5i 16V Limousine; 1.6i Limousine; 1.6i Hatchback; 1.8i 16V Limousine; 1.8i 16V Hatchback	59-82	09.93-		
<b>SHUMA (FB)</b>						
<b>KF 227</b>		1.5; 1.5i 16V	59-65	03.96-10.01		
<b>KF 225</b>		1.8 GX; 1.8i 16V	81-85	10.97-10.01		
<b>SHUMA II (FB)</b>						
<b>KF 225</b>		1.6 Limousine; 1.6 Hatchback	75	05.01-08.04		
<b>KF 225</b>		1.8	84	04.03-08.04		
<b>LADA</b>						
<b>1200-1500</b>						
<b>KA 055</b>		1200 (VAZ,WAS2102); 1300 (VAZ21021); 1500 (VAZ 2102)	44-54	09.73-06.85		<b>KC 205</b>
<b>1200-1600</b>						
<b>KA 055</b>		1200 L/S (VAZ,WAS2101); 1300 (VAZ2101); 1300 (WAS21011); 1500 (WAS2103,2106); 1500 N/S (VAZ2103); 1600 (WAS2106);	44-58	01.70-01.87		<b>KC 205</b>
<b>NIVA (2121)</b>						
<b>KA 024</b>		1600; 1700; 1700i	54-60	12.76-		<b>KC 205</b>
<b>KA 024</b>		1900 D; 1900 Diesel	47-55	01.93-		<b>KC 205</b>
<b>NOVA (2104)</b>						
<b>KA 055</b>		1300; 1500	48-55	09.85-		<b>KC 205</b>
<b>NOVA (2105,2108,2109)</b>						
<b>KA 055</b>		1200 JUNIOR ,L (VAZ,WAS 2105); 1300 SPEZIAL ,L( VAZ,WAS 2105); 1500 SPECIAL (VAZ 2105);	44-56	05.81-		<b>KC 205</b>
<b>TOSCANA</b>						
<b>KA 055</b>		1300 (VAZ2107); 1500 (VAZ2107)	48-55	09.83-		<b>KC 205</b>
<b>LANCIA</b>						
<b>A 112</b>						
<b>KF 161</b>		0.9 Junior; 1.0 Abarth; 1.0 LX	29-51	03.78-12.86		<b>KV 162</b>
<b>DEDRA (835)</b>						
<b>KF 165</b>	ABS	1.6 i.e. Limousine	55	04.93-07.99	ABS	<b>KV 218</b>
<b>KF 165</b>	ABS	1.6 i.e. Limousine	55	04.93-07.99	ABS	<b>KV 164</b>
<b>KF 165</b>	ABS	1.6 i.e. Limousine	57	08.89-03.93	ABS	<b>KV 164</b>
<b>KF 165</b>	ABS	1.6 i.e. Limousine	66	08.89-06.94	ABS	<b>KV 164</b>
		1.6 i.e. Limousine	66	08.89-06.94	ABS / 02.93 -->	<b>KV 218</b>
<b>KF 165</b>	ABS	1.6 Estate Car; 1.6 LE Limousine	66	07.94-07.99	ABS	<b>KV 218</b>
<b>KF 165</b>	ABS	1.6 Estate Car; 1.6 LE Limousine	66	07.94-07.99	ABS	<b>KV 164</b>
<b>KF 166</b>	ABS	1.6 16V Limousine; 1.6 16V Estate Car; 1.8 Estate Car; 1.8 GT Limousine; 1.8 GT 16V Estate Car; 1.8 i.e. Limousine; 1.8 i.e./LE Limousine; 1.8 LE Limousine; 1.8 LE Estate Car	66-96	08.93-07.99	ABS	<b>KV 218</b>
<b>KF 166</b>	ABS	1.6 16V Limousine; 1.6 16V Estate Car; 1.8 Estate Car; 1.8 GT Limousine; 1.8 GT 16V Estate Car; 1.8 i.e. Limousine; 1.8 i.e./LE Limousine; 1.8 LE Limousine; 1.8 LE Estate Car	66-96	08.93-07.99	ABS	<b>KV 164</b>
<b>KF 166</b>	ABS	1.8 i.e. Limousine; 2.0 i.e. Limousine	77-83	09.89-07.99	ABS	<b>KV 164</b>
		1.8 i.e. Limousine; 2.0 i.e. Limousine	77-83	09.89-07.99	ABS / --> 01.93	<b>KV 164</b>
		1.8 i.e. Limousine; 2.0 i.e. Limousine	77-83	09.89-07.99	ABS / 02.93 -->	<b>KV 218</b>
		1.8 i.e. Limousine; 2.0 i.e. Limousine	77-83	09.89-07.99	ABS	<b>KV 164</b>

	<b>i</b>	<b>ENGINE</b>	<b>POWER (kW)</b>	<b>YEAR</b>	<b>i</b>	
Fersa KIT FRONT						Fersa KIT REAR
<b>LANCIA</b>						
<b>DEDRA (835)</b>						
<b>KF 166</b>	ABS	2.0 i.e. Limousine	86	09.89-07.92		
<b>KF 166</b>	ABS	2.0 HF INTEGRALE Limousine; 2.0 i.e. TURBO INTEGRALE Limousine;	102-124	05.90-07.99	ABS	<b>KF 166</b>
<b>KF 166</b>	ABS	2.0 Estate Car; 2.0 16V Limousine; 2.0 i.e. TURBO Limousine; 2.0 TURBO Limousine	102-130	11.90-07.99	ABS	<b>KV 218</b>
<b>KF 166</b>	ABS	2.0 Estate Car; 2.0 16V Limousine; 2.0 i.e. TURBO Limousine; 2.0 TURBO Limousine	102-130	11.90-07.99	ABS	<b>KV 164</b>
<b>KF 166</b>	ABS	1.9 TDS Limousine	66	04.89-07.99	ABS	<b>KV 164</b>
		1.9 TDS Limousine	66	04.89-07.99	ABS / --> 01.93	<b>KV 164</b>
		1.9 TDS Limousine	66	04.89-07.99	ABS / 02.93 -->	<b>KV 218</b>
<b>KF 166</b>	ABS	1.9 TDS Estate Car	66	07.94-07.99	ABS	<b>KV 218</b>
<b>KF 166</b>	ABS	1.9 TDS Estate Car	66	07.94-07.99	ABS	<b>KV 164</b>
<b>DELTA (831AB0)</b>						
		1.1; 1.3; 1.5	47-63	09.79-12.92		<b>KV 162</b>
<b>KF 261</b>		2.0 HF INTEGRALE	130	12.86-12.92		
<b>KF 203</b>		Delta	51-66	86-87		<b>KF 203</b>
		Delta	51-66	88-03.88		<b>KF 203</b>
<b>KF 261</b>		2.0 HF INTEGRALE 16V	144	03.89-09.91		
<b>KF 261</b>		2.0 HF INTEGRALE 16V Evo.	155	06.93-01.94		<b>KF 261</b>
<b>DELTA II (836)</b>						
<b>KF 168</b>		Delta II	51-66	93-06.99		<b>KV 164</b>
<b>KF 168</b>	ABS	Delta II	51-66	93-06.99		
<b>KF 165</b>	ABS	1.4; 1.6; 1.6 i.e.	51-66	06.93-08.99	ABS	<b>KV 218</b>
<b>KF 165</b>	ABS	1.4; 1.6; 1.6 i.e.	51-66	06.93-08.99		<b>KV 162</b>
<b>KF 165</b>	ABS	1.6	76	01.96-08.99	ABS	<b>KV 218</b>
<b>KF 165</b>	ABS	1.6	76	01.96-08.99	ABS	<b>KV 164</b>
<b>KF 166</b>	ABS	1.7; 1.8; 1.8 GT; 1.8 i.e.; 2.0 16V	66-102	06.93-08.99	ABS	<b>KV 218</b>
<b>KF 166</b>	ABS	1.7; 1.8; 1.8 GT; 1.8 i.e.; 2.0 16V	66-102	06.93-08.99	ABS	<b>KV 164</b>
<b>KF 264</b>		2.0 HPE; 2.0 TURBO	137-142	06.93-08.99	ABS	<b>KV 218</b>
<b>KF 264</b>		2.0 HPE; 2.0 TURBO	137-142	06.93-08.99	ABS	<b>KV 164</b>
<b>KF 166</b>		1.9 TD	66	10.94-08.99	ABS	<b>KV 218</b>
<b>KF 166</b>		1.9 TD	66	10.94-08.99	ABS	<b>KV 164</b>
<b>KAPPA (838)</b>						
<b>KF 264</b>	CH. -->2084918	2.0 16V TURBO Limousine; 2.0 16V TURBO Estate Car	151	02.95-10.01		
<b>KF 264</b>	CH. --> 1002100	2.0 16V TURBO Coupe	151	11.96-03.01		
<b>KF 264</b>	CH. -->2084918	2.0 Limousine; 2.0 20V Limousine; 2.0 20V Estate Car	107-114	10.94-10.01		
<b>KF 264</b>	CH. --> 1002100	2.0 20V Coupe	114	07.96-03.01		
<b>KF 264</b>	CH. -->2084918	2.0 20V TURBO Limousine; 2.0 20V TURBO Estate Car	162	06.98-10.01		
<b>KF 264</b>	CH. --> 1002100	2.0 20V TURBO Coupe	162	06.98-03.01		
<b>KF 264</b>	CH. -->2084918	2.4 20V Limousine; 2.4 20V Estate Car	129	08.94-10.01		
<b>KF 264</b>	CH. --> 1002100	2.4 20V Coupe	129	11.96-03.01		
<b>KF 264</b>	CH. -->2084918	3.0 24V Limousine; 3.0 24V Estate Car	150	08.94-10.01		
<b>KF 264</b>	CH. --> 1002100	3.0 24V Coupe	150	11.96-03.01		
<b>KF 264</b>		2.4 TD Limousine; 2.4 TD Estate Car	91	08.94-10.01		
<b>LYBRA (839)</b>						
<b>KF 283</b>	ABS	1.6 16V; 1.8 16V	76-96	07.99-	ABS	<b>KV 251</b>
		2.0; 2.0 20V	110-113	07.99-	ABS	<b>KV 251</b>
		1.9 JTD; 2.4 JTD	77-110	07.99-	ABS	<b>KV 251</b>
<b>MUSA</b>						
<b>KF 346</b>	ABS	1.4	57-70	10.04-	ABS	<b>KV 251</b>
<b>KF 283</b>	ABS	1.3 Multijet; 1.9 Multijet	51-74	10.04-	ABS	<b>KV 251</b>

		<b>i</b>	ENGINE	POWER (kW)	YEAR	<b>i</b>	
Fersa KIT FRONT							Fersa KIT REAR
<b>LANCIA</b>							
<b>PHEDRA</b>							
			2.0	100	09.02-		<b>KV 294</b>
<b>KA 091</b>			3.0 V6	150	09.02-		<b>KV 294</b>
			2.0 JTD; 2.2 JTD	79-94	09.02-		<b>KV 294</b>
<b>PRISMA (831AB0)</b>							
			1.3; 1.5	55-63	01.83-02.92		<b>KV 162</b>
<b>THEMA (834)</b>							
<b>KF 261</b>			2000 i.e.; 2000 i.e.; 2000 i.e. 16V; 2000 i.e. 16V Estate Car; 2000 i.e. TURBO; 2000 TURBO 16V Estate Car	83-110	11.84-08.92		
<b>KF 264</b>			2000 16V; 2000 16V Estate Car	112	05.92-07.94		
<b>KF 261</b>			2000 16V TURBO; 2000 i.e. 16V TURBO; 2000 i.e. 16V TURBO Estate Car; 2000 i.e. TURBO	122-133	11.84-03.93		
<b>KF 264</b>			2000 16V TURBO; 2000 TURBO 16V Estate Car	148	10.92-07.94		
<b>KF 261</b>			2850 V6 i.e.	108-110	11.84-05.92		
<b>KF 264</b>			3000 V6; 3000 V6 Estate Car	126	08.92-07.94		
<b>KF 261</b>			2500 D; 2500 DS; 2500 TD Estate Car; 2500 TURBO DS Estate Car	74-85	11.84-07.92		
<b>KF 264</b>			2500 DS; 2500 TD Estate Car	85	05.92-07.94		
<b>Y (840A)</b>							
<b>KF 165</b>	ABS / VIN. --> 3336901		1.1; 1.2; 1.2 16V; 1.4 12V	40-63	11.95-09.03	ABS / VIN. --> 3336901	<b>KV 237</b>
<b>KF 346</b>	ABS / VIN. 3336902 -->		1.1; 1.2; 1.2 16V; 1.4 12V	40-63	11.95-09.03	ABS / VIN. 3336902 -->	<b>KV 251</b>
<b>KF 165</b>	ABS		1.1; 1.2; 1.2 16V; 1.4 12V	40-63	11.95-09.03	ABS	<b>KV 164</b>
<b>Y10 (156)</b>							
<b>KV 163</b>			1.0 Fire	32-37	03.85-02.92		<b>KV 162</b>
<b>KV 163</b>			1.0 Fire 4WD	32-37	12.86-02.92		
<b>KV 163</b>			1.0; 1.0 TURBO; 1.1 Avenue; 1.1 Fire; 1.1 i.e	37-62	03.85-12.95		<b>KV 162</b>
<b>KV 163</b>			1.1 Avenue 4WD; 1.1 i.e. Fire 4WD; 1.1 i.e 4WD	37-42	08.89-12.95		
<b>KV 163</b>			1.3 i.e. Fire	53-56	11.87-12.95		<b>KV 162</b>
<b>YPSILON</b>							
<b>KF 346</b>			1.2; 1.4	44-70	10.03-	ABS	<b>KV 251</b>
<b>KF 283</b>	ABS		1.3 JTD; 1.3 Multijet	51-66	10.03-	ABS	<b>KV 251</b>
<b>ZETA (220)</b>							
<b>KF 113</b>			2.0 16V; 2.0 TURBO	97-108	05.95-09.02	ABS	<b>KV 236</b>
<b>KF 113</b>			2.0 JTD; 2.1 TD	80	05.96-09.02	ABS	<b>KV 236</b>
<b>LAND ROVER</b>							
<b>80/109</b>							
<b>KA 050</b>	10.80 -->		2.3; 3.5	51-68	09.63-12.86	10.80 -->	<b>KA 050</b>
<b>KA 050</b>	10.80 -->		2.3 D	46	09.63-12.86	10.80 -->	<b>KA 050</b>
<b>90/110</b>							
<b>KA 050</b>	AXLE --> 20L13358B		2.5; 3.5 V8	62-100	09.83-07.90	AXLE --> 20L13358B	<b>KA 050</b>
<b>KA 050</b>	AXLE --> 21L10631B		2.5; 3.5 V8	62-100	09.83-07.90	AXLE --> 21L10631B	<b>KA 050</b>
<b>KA 050</b>	AXLE --> 21S22954B		2.5; 3.5 V8	62-100	09.83-07.90	AXLE --> 21S22954B	<b>KA 050</b>
<b>KA 052</b>	AXLE 20L13359B -->		2.5; 3.5 V8	62-100	09.83-07.90	AXLE 20L13359B -->	<b>KA 052</b>
<b>KA 052</b>	AXLE 21L10632B -->		2.5; 3.5 V8	62-100	09.83-07.90	AXLE 21L10632B -->	<b>KA 052</b>
<b>KA 052</b>	AXLE 21S22955B -->		2.5; 3.5 V8	62-100	09.83-07.90	AXLE 21S22955B -->	<b>KA 052</b>
<b>KA 050</b>	AXLE --> 20L13358B		2.5 TD	63	09.86-07.90	AXLE --> 20L13358B	<b>KA 050</b>
<b>KA 050</b>	AXLE --> 21L10631B		2.5 TD	63	09.86-07.90	AXLE --> 21L10631B	<b>KA 050</b>
<b>KA 050</b>	AXLE --> 21S22954B		2.5 TD	63	09.86-07.90	AXLE --> 21S22954B	<b>KA 050</b>
<b>KA 052</b>	AXLE 20L13359B -->		2.5 TD	63	09.86-07.90	AXLE 20L13359B -->	<b>KA 052</b>
<b>KA 052</b>	AXLE 21L10632B -->		2.5 TD	63	09.86-07.90	AXLE 21L10632B -->	<b>KA 052</b>



 Fersa KIT FRONT	<b>i</b>	ENGINE	POWER (kW)	YEAR	<b>i</b>	Fersa KIT REAR 
<b>LAND ROVER</b>						
90/110						
KA 052	AXLE 21S22955B -->	2.5 TD	63	09.86-07.90	AXLE 21S22955B -->	KA 052
<b>DEFENDER</b>						
KA 052		3.9 V8	136	11.98-		KA 052
KA 052		2.5 90,110 TDI; 2.5 90 TDI; 2.5 Td5 4WD; 2.5 Tdi 4WD	83-90	09.90-		KA 052
<b>DISCOVERY I</b>						
KA 052		2.0 16 V	99	09.93-06.94		KA 052
KA 053	AXLE --> JA032850	3.5	113	09.89-06.94	AXLE --> JA032850	KA 053
KA 052	AXLE JA032851 -->	3.5	113	09.89-06.94	AXLE JA032851 -->	KA 052
KA 052	ABS	3.9 V8	134	09.93-06.94		KA 052
KA 053	AXLE --> JA032850	2.5 D	83	09.89-06.94	AXLE --> JA032850	KA 053
KA 052	AXLE JA032851 -->	2.5 D	83	09.89-06.94	AXLE JA032851 -->	KA 052
<b>DISCOVERY II (LJ,LT)</b>						
KA 052		2.0 16 V; 3.9 V8	99-134	06.94-		KA 052
KA 052		2.5 D; 2.5 TDI	83-90	10.95-		KA 052
<b>LAND ROVER</b>						
KA 051		2.3	46	58-09.80		KA 051
KA 050	10.80 -->	2.3	51	09.63-12.86	10.80 -->	KA 050
KA 050	10.80 -->	2.3 D	46	09.63-12.86	10.80 -->	KA 050
<b>RANGE ROVER I</b>						
KA 050	--> 06.85	3.5 VOGUE	93	08.81-09.90	--> 06.85	KA 050
KA 053	07.85 --> / --> 12.89	3.5 VOGUE	93	08.81-09.90	07.85 --> / --> 12.89	KA 053
KA 052	ABS / 01.90 -->	3.5 VOGUE	93	08.81-09.90	ABS / 01.90 -->	KA 052
KA 053	ABS / 01.90 -->	3.5 VOGUE	93	08.81-09.90	ABS / 01.90 -->	KA 053
KA 053	--> 12.89	3.5; 3.5 VOGUE	107-120	10.85-09.90	--> 12.89	KA 053
KA 052	ABS / 01.90 -->	3.5; 3.5 VOGUE	107-120	10.85-09.90	ABS / 01.90 -->	KA 052
KA 053	ABS / 01.90 -->	3.5; 3.5 VOGUE	107-120	10.85-09.90	ABS / 01.90 -->	KA 053
KA 050		3.5	97	07.70-08.81		KA 050
KA 053	--> 12.89	3.9; 3.9 VOGUE SEI	127-134	11.88-07.94	--> 12.89	KA 053
KA 052	ABS / 01.90 -->	3.9; 3.9 VOGUE SEI	127-134	11.88-07.94	ABS / 01.90 -->	KA 052
KA 053	ABS / 01.90 -->	3.9; 3.9 VOGUE SEI	127-134	11.88-07.94	ABS / 01.90 -->	KA 053
KA 052		4.3 VOGUE LSE	149	09.92-07.94		KA 052
KA 053	ABS	4.3 VOGUE LSE	149	09.92-07.94	ABS	KA 053
KA 053	--> 12.89	2.4 D	78	04.86-12.90	--> 12.89	KA 053
KA 052	ABS / 01.90 -->	2.4 D	78	04.86-12.90	ABS / 01.90 -->	KA 052
KA 053	ABS / 01.90 -->	2.4 D	78	04.86-12.90	ABS / 01.90 -->	KA 053
<b>RANGE ROVER II</b>						
KA 052	ABS	3.9; 4.0; 4.6	136-165	07.94-03.02	ABS	KA 052
KA 052	ABS	2.5 D	83-100	07.94-03.02	ABS	KA 052
<b>MAZDA</b>						
121 I (DA)						
KA 214		1.1; 1.3	40-44	10.87-10.90		
323 III (BF,BW)						
KA 214		1.1 Limousine; 1.1 Hatchback	40	08.85-04.90		
KA 214		1.3 Estate Car	44	07.86-04.90		
KA 214		1.3 Limousine; 1.3 Hatchback; 1.3i Hatchback; 1.4 Limousine; 1.4 Hatchback	44-49	08.85-10.89		
KA 214		1.5 Estate Car	55	05.86-05.89		
KA 214		1.5 Limousine; 1.5 Hatchback; 1.5 i TURBO Limousine; 1.5 i TURBO Hatchback; 1.5i Limousine; 1.5i Hatchback	54-85	08.85-10.89		

		<b>i</b>	<b>ENGINE</b>	<b>POWER (kW)</b>	<b>YEAR</b>	<b>i</b>	
Fersa KIT FRONT							Fersa KIT REAR
<b>MAZDA</b>							
<b>323 III (BF,BW)</b>							
<b>KA 214</b>			1.5 Estate Car; 1.6 Estate Car	54	01.87-10.89		
<b>KA 214</b>			1.6 Hatchback; 1.6 GT Limousine; 1.6 GT Hatchback	54-63	11.86-10.89		
<b>KA 214</b>			1.6 Estate Car	63	09.86-10.95		
<b>KA 214</b>			1.6 Hatchback; 1.6 GT Limousine; 1.6 GT TURBO Limousine; 1.6 GT Turbo (BF1) Hatchback	77-103	08.85-11.91		
<b>KA 214</b>			1.7 D Limousine; 1.7 D Hatchback	40	04.86-05.89		
<b>KA 214</b>			1.7 D Estate Car	40	11.86-08.87		
<b>KA 214</b>			1.7 D Estate Car	41-42	11.86-03.93		
<b>KA 214</b>			1.7 D Limousine; 1.7 D Hatchback	42	01.87-05.89		
<b>323 IV (BG)</b>							
<b>KF 227</b>			1.3; 1.3 16V; 1.6; 1.6 16V; 1.8 16V; 1.8 16V GT	49-94	06.89-10.94	ABS	<b>KV 232</b>
<b>KF 227</b>			1.3; 1.3 16V; 1.6; 1.6 16V; 1.8 16V; 1.8 16V GT	49-94	06.89-10.94	<del>ABS</del>	<b>KV 226</b>
<b>KF 227</b>			1.8 4WD	76	01.91-04.94		<b>KF 227</b>
<b>KF 227</b>			1.8 16V 4WD; 1.8 16V TURBO 4WD	76-136	09.90-07.94		<b>KF 225</b>
<b>KF 227</b>			1.7 D	41	08.89-07.94	ABS	<b>KV 232</b>
<b>KF 227</b>			1.7 D	41	08.89-07.94	<del>ABS</del>	<b>KV 226</b>
<b>323 V (BA)</b>							
<b>KF 227</b>			1.3 Limousine; 1.3 Hatchback	54	08.94-09.98	ABS	<b>KV 232</b>
<b>KF 227</b>			1.3 Limousine; 1.3 Hatchback	54	08.94-09.98	<del>ABS</del>	<b>KV 226</b>
<b>KF 227</b>			1.3 16V Hatchback	54	10.96-	ABS	<b>KV 232</b>
<b>KF 227</b>			1.3 16V Hatchback	54	10.96-	<del>ABS</del>	<b>KV 226</b>
<b>KF 227</b>			1.5 Limousine; 1.5 Hatchback; 1.5 Coupe	65	07.94-09.98	ABS	<b>KV 232</b>
<b>KF 227</b>			1.5 Limousine; 1.5 Hatchback; 1.5 Coupe	65	07.94-09.98	<del>ABS</del>	<b>KV 226</b>
<b>KF 227</b>			1.5 16V Hatchback	65	10.96-	ABS	<b>KV 232</b>
<b>KF 227</b>			1.5 16V Hatchback	65	10.96-	<del>ABS</del>	<b>KV 226</b>
<b>KF 227</b>			1.8 Hatchback; 1.8 Coupe; 1.9 Limousine; 2.0 V6 Coupe	84-106	08.94-09.98	ABS	<b>KV 232</b>
<b>KF 227</b>			1.8 Hatchback; 1.8 Coupe; 1.9 Limousine; 2.0 V6 Coupe	84-106	08.94-09.98	<del>ABS</del>	<b>KV 226</b>
<b>KF 227</b>			1.7 TD Limousine; 2.0 D Limousine	52-60	02.95-09.98	ABS	<b>KV 232</b>
<b>KF 227</b>			1.7 TD Limousine; 2.0 D Limousine	52-60	02.95-09.98	<del>ABS</del>	<b>KV 226</b>
<b>KF 227</b>			2.0 D Hatchback	52	10.96-	ABS	<b>KV 232</b>
<b>KF 227</b>			2.0 D Hatchback	52	10.96-	<del>ABS</del>	<b>KV 226</b>
<b>323 VI (BJ)</b>							
<b>KF 227</b>			1.3 16V Limousine; 1.3 16V Hatchback; 1.5 16V Limousine; 1.5 16V Hatchback; 1.8 16V Limousine; 1.8 16V Hatchback	54-84	09.98-05.04	ABS	<b>KV 232</b>
<b>KF 227</b>			1.3 16V Limousine; 1.3 16V Hatchback; 1.5 16V Limousine; 1.5 16V Hatchback; 1.8 16V Limousine; 1.8 16V Hatchback	54-84	09.98-05.04	ABS	<b>KV 226</b>
<b>KF 227</b>			2.0 D Limousine; 2.0 D Hatchback; 2.0 TD Limousine; 2.0 TD Hatchback	52-66	09.98-05.04	ABS	<b>KV 232</b>
<b>KF 227</b>			2.0 D Limousine; 2.0 D Hatchback; 2.0 TD Limousine; 2.0 TD Hatchback	52-66	09.98-05.04	ABS	<b>KV 226</b>
<b>626 III (GD,GV)</b>							
<b>KF 225</b>	CH. GE100001 -->		2.0 Estate Car	66	10.88-09.97		
<b>KF 225</b>	CH. GE100001 -->		2.0i Estate Car	110	11.94-09.97		
			2.2 12V 4WD Hatchback	85	11.87-07.90	CH. GD500005 --> / CH. --> GD700000	<b>KF 225</b>
<b>KF 225</b>	CH. GE100001 -->		2.2 12V Estate Car	85	03.89-11.96		
			2.2 12V 4WD Estate Car	85	05.91-11.92	--> 02.92	<b>KF 225</b>
<b>KF 227</b>	03.92 -->		2.2 12V 4WD Estate Car	85	05.91-11.92	03.92 -->	<b>KF 227</b>
<b>KF 225</b>	CH. GE100001 -->		2.0 D COMPREX Estate Car	55	05.93-11.96		
<b>KF 225</b>	CH. GE100001 -->		2.0 D Estate Car	60	11.94-09.97		
<b>KF 225</b>	CH. GE100001 -->		1.8 Hatchback; 1.8i Limousine; 2.0i Limousine; 2.0i Hatchback	66-85	08.91-04.97		
<b>KF 225</b>			2.0i 4WD Limousine; 2.0i 4WD Hatchback	85	04.92-04.97		<b>KF 225</b>

	<b>i</b>	<b>ENGINE</b>	<b>POWER (kW)</b>	<b>YEAR</b>	<b>i</b>	
Fersa KIT FRONT						Fersa KIT REAR
<b>MAZDA</b>						
<b>626 III (GD,GV)</b>						
<b>KF 225</b>	CH. GE100001 -->	2.5 24V Hatchback	120-121	01.92-04.97		
<b>KF 225</b>	CH. GE100001 -->	2.0 D GLX COMPREX Limousine; 2.0 D GLX COMPREX Hatchback	55	10.92-04.97		
<b>626 V (GF,GW)</b>						
<b>KF 225</b>		1.8 Limousine; 1.8 Hatchback	66	05.97-12.99		
<b>KF 225</b>		1.8 Estate Car	66	02.98-01.00		
<b>KF 225</b>		1.8 Limousine; 1.8 Hatchback	74	12.99-10.02		
<b>KF 225</b>		1.8 Estate Car	74	01.00-10.02		
<b>KF 225</b>		2.0 Limousine; 2.0 Hatchback	85	05.97-10.02		
<b>KF 225</b>		2.0 Estate Car	85	02.98-10.02		
<b>KF 225</b>		2.0 Limousine; 2.0 H.P. Hatchback	100	02.98-10.02		
<b>KF 225</b>		2.0 H.P. Estate Car	100	02.98-10.02		
<b>KF 225</b>		2.0 DTD Hatchback	66	04.98-10.02		
<b>KF 225</b>		2.0 DTD Estate Car	66	09.99-10.02		
<b>KF 225</b>		2.0 TURBO DI Limousine; 2.0 TURBO DI Hatchback	74	04.98-10.02		
<b>KF 225</b>		2.0 TURBO DI Estate Car	74	04.98-10.02		
<b>KF 225</b>		2.0 TD Limousine; 2.0 TD Hatchback	81	10.00-10.02		
<b>KF 225</b>		2.0 TD Estate Car	81	10.00-10.02		
<b>MX-3 (EC)</b>						
<b>KF 227</b>		1.6i; 1.8; 1.8i V6	65-98	07.91-		
		1.6i; 1.8; 1.8i V6	65-98	07.91-	ABS	<b>KV 232</b>
		1.6i; 1.8; 1.8i V6	65-98	07.91-	<b>ABS</b>	<b>KV 226</b>
<b>MX-5 I (NA)</b>						
		1.6; 1.8	66-96	05.90-04.98		<b>KF 227</b>
<b>MX-5 II (NB)</b>						
		1.6 16V; 1.8 16V; 1.9 16V	81-107	05.98-10.05		<b>KF 227</b>
<b>MX-6 (GE6)</b>						
<b>KF 225</b>		2.0; 2.5 V6; 2.5i V6	85-121	02.92-		
<b>PREMACY (CP)</b>						
<b>KF 227</b>		1.9; 2.0	74-96	07.99-		
<b>KF 227</b>		2.0 TD	66-74	10.99-		
<b>XEDOS 6 (CA)</b>						
<b>KF 225</b>		1.6 16V; 2.0 V6	79-106	01.92-		
<b>XEDOS 9 (TA)</b>						
<b>KF 225</b>		2.0 V6; 2.3 V6; 2.5 V6	105-155	07.93-07.00		
<b>MERCEDES BENZ</b>						
<b>100 (631)</b>						
<b>KA 033</b>		D	41-55	02.88-02.96		
		D	41-55	02.88-02.96	CH--> 128165	<b>KA 032</b>
<b>190 (W201)</b>						
<b>KA 030</b>		E 1.8	80	04.90-08.93		<b>KF 124</b>
<b>KA 030</b>	CH. 003514 -->	2.0	66	10.82-10.84		<b>KF 124</b>
<b>KA 030</b>		2.0; E 2.0	75-87	09.84-08.93		<b>KF 124</b>
<b>KA 030</b>	CH. 003514 -->	E 2.0	90	10.82-06.93		<b>KF 124</b>
<b>KA 030</b>	CH. 006893 -->	E 2.0	93	10.82-06.93		
		E 2.0	93	10.82-06.93	CH--> 006892	<b>KF 124</b>
<b>KA 030</b>		E 2.3	97-100	09.86-08.93		<b>KF 124</b>

	<b>i</b>	<b>ENGINE</b>	<b>POWER (kW)</b>	<b>YEAR</b>	<b>i</b>	
Fersa KIT FRONT						Fersa KIT REAR
<b>MERCEDES BENZ</b>						
<b>190 (W201)</b>						
KA 028		E 2.3-16; E 2.5-16	125-150	04.84-08.93		KF 124
KA 030		E 2.6; E EVOLUTION II 2.5	118-173	09.86-08.93		KF 124
KA 030		E 2.6; E EVOLUTION II 2.5	118-173	09.86-08.93		
KA 030		D 2.0; D 2.5; D 2.5 TURBO	53-93	08.83-08.93		KF 124
<b>200 - 280 E (W114, W115)</b>						
KA 025		200; 220	63-77	01.68-01.77		KA 026
KA 025		230.4; 230.6	81-88	01.68-12.76		
KA 025		250; 250 C; 250 CE	85-110	01.68-08.72		KA 026
		280	118	06.72-11.76		KA 026
KA 025		250 2.8; 250 C 2.8; 280 C; 280 CE; 280 E	96-136	06.72-02.77		KA 026
KA 025		200 D; 220 D; 240 D; 240 D 3.0	40-59	01.68-01.77		KA 026
<b>200 - 300 (C/S/W123)</b>						
KA 029	ABS	200; 200 T; 230; 230 C; 230 CE; 230 E; 230 T; 230 TE; 250; 250 T; 280	62-115	02.76-12.85		KA 026
KA 027	ABS	200; 200 T; 230; 230 C; 230 CE; 230 E; 230 T; 230 TE; 250; 250 T; 280	62-115	02.76-12.85		KA 026
KA 027	ABS	280 C; 280 CE	115-130	03.77-03.80		KA 026
KA 029	ABS	280 E	130-136	02.76-11.85		KA 026
KA 027	ABS	280 E	130-136	02.76-11.85		KA 026
KA 027	ABS	280 CE	136	03.77-11.85		KA 026
KA 029	ABS	280 TE	136	09.77-11.85		KA 026
KA 027	ABS	280 TE	136	09.77-11.85		KA 026
KA 029	ABS	200 D; 220 D; 240 D; 240 T D; 300 D; 300 T D; 300 T D TURBO; 300 TURBO D	40-92	01.76-12.85		KA 026
KA 027	ABS	200 D; 220 D; 240 D; 240 T D; 300 D; 300 T D; 300 T D TURBO; 300 TURBO D	40-92	01.76-12.85		KA 026
<b>200 - 320 (A/C/S/W124)</b>						
KA 028		200	75-77	01.86-05.90		KF 124
KA 028		200	75-77	01.86-05.90		
KA 028		200 T	77	01.86-05.90		KB 125
KA 028		200 T	80	09.85-08.89		KB 125
KA 028		200	80	12.85-05.90		KF 124
KA 028		200 E	87	09.88-08.92		KF 124
KA 028		200 TE	87-90	09.88-08.92		KB 125
KA 028		200 E	90-100	09.88-06.93		KF 124
KA 028		200 TE	100	10.92-06.93		KB 125
KA 028		220 CE; 220 E	110	10.92-06.93		KF 124
KA 028		220 TE	110	10.92-05.93		KB 125
KA 028		230 CE; 230 E	97	12.84-06.93		KF 124
KA 028		230 TE	97	09.85-08.92		KB 125
KA 028		230 CE; 230 E	100	01.85-06.93		KF 124
KA 028		230 TE	100	09.85-08.92		KB 125
KA 028		260 E	118	09.85-08.92		KF 124
KA 028		260 E	118	09.85-08.92		KB 125
		260 E 4-matic	118	09.86-08.92		KF 124
KA 189		260 TE	118	09.89-08.92		
KA 028		260 E	122	09.85-12.89		KF 124
KA 028		260 E	122	09.85-12.89		KB 125
KA 189		260 TE	122	09.85-12.89		KF 124

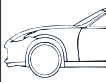
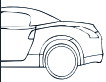
	<b>i</b>	ENGINE	POWER (kW)	YEAR	<b>i</b>	
Fersa KIT FRONT						Fersa KIT REAR
<b>MERCEDES BENZ</b>						
<b>200 - 320 (A/C/S/W124)</b>						
KA 028		280 E	145	10.92-06.93		KF 124
KA 028		280 E	145	10.92-06.93		KB 125
KA 028		280 TE	145	10.92-06.93		KB 125
KA 028		300 CE; 300 E	132	08.85-05.93		KF 124
KA 028		300 TE	132	01.86-08.92		KB 125
KA 028		300 E 4-matic	132	09.86-06.93		KF 124
KA 028		300 TE 4-matic	132	09.86-06.93		KB 125
KA 028		300 CE; 300 E	138	01.85-08.92		KF 124
KA 028		300 TE	138	01.86-12.89		KB 125
KA 028		300 E 4-matic	138	09.86-02.92		KF 124
KA 028		300 TE 4-matic	138	09.86-12.89		KB 125
KA 028		300 E-24	162	09.88-08.92		KF 124
KA 028		300 CE-24	162	09.89-12.92		KF 124
KA 028		300 TE-24	162	09.89-08.92		KB 125
KA 189		300 CE-24	162	04.92-06.93		KF 124
KA 028		320 CE; 320 E	162	10.92-06.93		KF 124
KA 028		E 320 T	162	10.92-06.93		KB 125
KA 189		400 E 4.2	205	10.92-06.93		KF 124
KA 189		400 E 4.2	205	10.92-06.93		
KA 189		500 E	240	01.91-06.93		KF 124
KA 189		500 E	240	01.91-06.93		
KA 028		200 D	53	12.84-08.89		KF 124
KA 028		200 D	53	12.84-08.89		
KA 028		200 T D	53	09.85-08.91		KB 125
KA 028		200 T D	55	09.88-08.91		KB 125
KA 028		200 D	55	08.89-06.93		KF 124
KA 028		200 D	55	08.89-06.93		
KA 028		250 D	66	04.85-06.93		KF 124
KA 028		250 D	66	04.85-06.93		KB 125
KA 028		250 D	66	04.85-06.93		
KA 028		250 T D	66	09.85-06.93		KB 125
KA 028		250 D	69	01.89-06.93		KF 124
KA 028		250 D	69	01.89-06.93		KB 125
KA 028		250 D	69	01.89-06.93		
KA 028		250 T D	69	01.89-06.93		KB 125
KA 028		250 TURBO D	93	09.88-06.93		KF 124
KA 028		250 TURBO D	93	09.88-06.93		
KA 028		300 D	80	12.84-08.89		KF 124
KA 028		300 T D	80	09.86-06.93		KB 125
KA 027	ABS	300D (123)	132	80-85		KA 029
KA 027	ABS	300TD (123)	132	76-85		KA 029
KA 028		300 D 4-matic; 300 TURBO D 4-matic	80-105	09.86-06.93		KF 124
KA 028		300 T D	81	01.89-06.93		KB 125
KA 028		300 D	81	06.90-06.93		KF 124
KA 028		300 T D	83	01.89-06.93		KB 125
KA 028		300 D	83	08.89-06.93		KF 124
KA 028		300 TURBO D	105	09.86-09.88		KF 124
KA 028		300 T TURBO D	105-108	09.86-06.93		KB 125
KA 028		300 T TURBO D 4-matic	105-108	09.86-06.93		KB 125
KA 028		300 TURBO D 4-matic	108	01.88-06.93		KF 124

	<b>i</b>	ENGINE	POWER (kW)	YEAR	<b>i</b>	
Fersa KIT FRONT						Fersa KIT REAR
<b>MERCEDES BENZ</b>						
<b>200 - 320 (A/C/S/W124)</b>						
<b>KA 028</b>		300 TURBO D	108	09.88-06.93		<b>KF 124</b>
<b>A-KLASSE/CLASS (W168)</b>						
<b>KA 028</b>		1.9 A 190 Twin Engine; A 140; A 160; A 190; A 210	60-184	07.97-08.04	CH. J568589 -->	<b>KB 345</b>
<b>KA 028</b>		A 160 CDI	44	07.98-02.01		<b>KB 345</b>
<b>KA 028</b>		A 160 CDI	55	02.01-08.04	CH. J568589 -->	<b>KB 345</b>
<b>KA 028</b>		A 170 CDI	66	07.98-02.01		<b>KB 345</b>
<b>KA 028</b>		A 170 CDI	70	02.01-08.04	CH. J568589 -->	<b>KB 345</b>
<b>C-KLASSE/CLASS (S/W202)</b>						
<b>KA 189</b>		C 180; C 180 T; C 200; C 200 KOMPRESSOR; C 200 T; C 220; C 230; C 230 KOMPRESSOR; C 230 T; C 230 T KOMPRESSOR; C 240; C 240 T	89-142	03.93-03.01		<b>KF 124</b>
<b>KA 189</b>		C 280	142	05.93-05.00		<b>KF 124</b>
<b>KA 189</b>		C 280; C 280 T	145	06.97-03.01		<b>KF 124</b>
<b>KA 189</b>		C 36 AMG; C 43 AMG	206-225	05.94-05.00		<b>KF 124</b>
<b>KA 189</b>		C 200 D; C 200 T D	55-65	03.93-03.01		<b>KF 124</b>
<b>KA 189</b>		C 200 CDI; C 200 T CDI; C 220 CDI; C 220 T CDI	75-92	09.97-03.01		<b>KF 124</b>
<b>KA 189</b>		C 220 D; C 220 T D; C 250 D; C 250 T TURBO D;	55-110	05.93-03.01		<b>KF 124</b>
<b>C-KLASSE/CLASS (CL/S/W203)</b>						
		C 160 Kompressor (203.730); C 180; C 180 Kompressor; C 200 CGI; C 200 Kompressor; C 220; C 230; C 230 (203.052);	90-150	05.00-		<b>KF 124</b>
<b>KF 127</b>		C 240 4-matic	125	07.02-		<b>KF 124</b>
<b>KF 127</b>		C 280	170	01.05-		<b>KF 124</b>
<b>KF 127</b>		C 280 4-matic	170	01.05-		<b>KF 124</b>
<b>KF 127</b>		C 320 4-matic	160	07.02-		<b>KF 124</b>
<b>KF 127</b>		C 32 AMG; C 320	160-260	05.00-		<b>KF 124</b>
<b>KF 127</b>		3.5; C 350	170-200	01.05-		<b>KF 124</b>
<b>KF 127</b>		C 350 4-matic	200	01.05-		<b>KF 124</b>
<b>KF 127</b>		C 55 AMG	270	02.04-		<b>KF 124</b>
<b>KF 127</b>		C 200 CDI; C 220 CDI; C 220 CDI (203.008); C 220 CDI (203.208); C 220 CDI (203.708); C 270 CDI; C 30 CDI;	75-170	05.00-		<b>KF 124</b>
<b>CLK (A/C208)</b>						
<b>KA 189</b>		200 Coupe; 200 Convertible; 200 Kompressor Convertible	100-120	06.97-06.02		<b>KF 124</b>
<b>KA 189</b>		200 Kompressor Coupe	141	06.97-06.00		<b>KF 124</b>
<b>KA 189</b>		200 Kompressor Convertible	141	03.98-06.00		<b>KF 124</b>
<b>KA 189</b>		230 Kompressor Coupe; 230 Kompressor Convertible	142	06.97-06.00		<b>KF 124</b>
<b>KA 189</b>		230 Kompressor Convertible	145	06.00-03.02		<b>KF 124</b>
<b>KA 189</b>		320 Coupe; 320 Convertible; 430 Coupe; 430 Convertible	160-205	06.97-06.02		<b>KF 124</b>
<b>KA 189</b>		55 AMG Convertible	255	01.00-03.02		<b>KF 124</b>
<b>E-KLASSE/CLASS (A/C/S/W124)</b>						
<b>KA 028</b>		E 200; E 200 Coupe; E 200 Convertible	100	06.93-03.98		<b>KF 124</b>
<b>KA 028</b>		E 200 T	100	06.93-06.96		<b>KB 125</b>
<b>KA 028</b>		E 220; E 220 Coupe; E 220 Convertible	110	06.93-03.98		<b>KF 124</b>
<b>KA 028</b>		E 220 T	110	06.93-06.96		<b>KB 125</b>
<b>KA 189</b>		E 280	142	06.93-06.95		<b>KB 125</b>
<b>KA 028</b>		E 280 T	142	06.93-06.96		<b>KB 125</b>
<b>KA 028</b>		E 280	145	06.93-06.95		<b>KF 124</b>
<b>KA 028</b>		E 280 T	145	06.93-06.96		<b>KB 125</b>
<b>KA 028</b>		E 300 4-matic	132	06.93-06.95		<b>KF 124</b>
<b>KA 028</b>		E 300 T 4-matic	132	06.93-06.96		<b>KB 125</b>
<b>KA 028</b>		E 320	162	06.93-06.95		<b>KF 124</b>
<b>KA 189</b>		E 320 Coupe; E 320 Convertible	162	06.93-03.98		<b>KF 124</b>

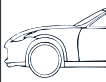
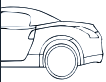
	<b>i</b>	<b>ENGINE</b>	<b>POWER (kW)</b>	<b>YEAR</b>	<b>i</b>	
Fersa KIT FRONT						Fersa KIT REAR
<b>MERCEDES BENZ</b>						
<b>E-KLASSE/CLASS (A/C/S/W124)</b>						
KA 028		E 320 T	162	06.93-06.96		KB 125
KA 189		E 420; E 500	205-235	06.93-06.95		KF 124
KA 028		E 200 D	55	06.93-06.95		KF 124
KA 028		E 250 T D	83	06.93-06.96		KB 125
KA 028		E 250	83	07.93-06.95		KF 124
KA 028		E 250	83	07.93-06.95		KB 125
KA 028		E 250 TURBO D; E 300 D	93-100	06.93-06.95		KF 124
KA 028		E 300 T D; E 300 T TURBO D	100-108	06.93-06.96		KB 125
KA 028		E 300 TURBO D	108	06.93-06.95		KF 124
KA 028		E 300 T TURBO D 4-matic	108	06.93-06.96		KB 125
KA 028		E 300 TURBO D 4-matic	108	06.93-06.95		KF 124
<b>E-KLASSE/CLASS (S/W210)</b>						
KA 189		E 200	100	06.95-08.00		KF 124
KA 189		E 200	100	06.95-08.00		
KA 189		E 200 T	100	06.96-08.00		KF 300
KA 189		E 200 Kompressor	120	08.00-03.02		KF 124
KA 189		E 200 T Kompressor	120	08.00-03.03		KF 300
KA 189		E 200 Kompressor	137	06.97-03.02		KF 124
KA 189		E 200 T Kompressor	137	06.97-03.03		KF 300
KA 189		E 230	110	06.95-06.97		KF 124
KA 189		E 230 T	110	06.96-06.97		KF 300
KA 189		E 240	125	06.97-08.00		KF 124
KA 189		E 240 T	125	06.97-03.03		KF 300
KA 189		E 240	125	08.00-03.02		KF 124
KA 189		E 240 T	125	08.00-03.03		KF 300
KA 189		E 280	142	01.96-06.97		KF 124
KA 189		E 280	150	12.96-03.02		KF 124
KA 189		E 280 T	150	12.96-03.03		KF 300
		E 280 4-matic	150	12.96-03.02		KF 124
		E 280 T 4-matic	150	12.96-03.03		KF 300
KA 189		E 320	162-165	06.95-03.02		KF 124
KA 189		E 320 T	165	12.96-03.03		KF 300
		E 320 4-matic	165	06.97-03.02		KF 124
KA 189		E 420	205	01.96-06.97		KF 124
KA 189		E 420 T	205	06.96-06.97		KF 300
KA 189		E 430	205	06.97-03.02		KF 124
KA 189		E 430 T	205	06.97-03.03		KF 300
		E 430 4-matic	205	05.99-03.02		KF 124
		E 430 T 4-matic	205	05.99-03.03		KF 300
KA 189		E 50 AMG	255	02.96-08.97		KF 124
KA 189		E 55 AMG	260	08.97-03.02		KF 124
KA 189		E 55 T AMG	260	08.97-03.03		KF 300
		E 55 AMG 4-matic	260	03.01-03.02		KF 124
KA 189		E 200 CDI; E 200 D; E 220 CDI	65-105	01.96-03.02		KF 124
KA 189		E 220 T CDI	105	07.99-03.03		KF 124
KA 189		E 200 CDI; E 220 CDI	75-92	06.98-03.02		KF 124
KA 189		E 220 T CDI	92	06.98-07.99		KF 300
KA 189		E 220 D; E 250 D	55-83	06.95-03.02		KF 124
KA 189		E 250 T D	83	06.96-07.99		KF 300
KA 189		E 250 T TURBO D	110	06.97-07.99		KF 300



		<b>i</b>	<b>ENGINE</b>	<b>POWER (kW)</b>	<b>YEAR</b>	<b>i</b>	
Fersa KIT FRONT							Fersa KIT REAR
<b>MERCEDES BENZ</b>							
<b>E-KLASSE/CLASS (S/W210)</b>							
<b>KA 189</b>			E 250 TURBO D; E 270 CDI	110-125	06.97-03.02		<b>KF 124</b>
<b>KA 189</b>			E 270 T CDI	125	07.99-03.03		
<b>KA 189</b>			E 290 T TURBO D	95	06.96-07.99		<b>KF 300</b>
<b>KA 189</b>			E 290 TURBO D; E 300 D	95-100	06.95-07.99		<b>KF 124</b>
<b>KA 189</b>			E 300 T TURBO D	130	12.96-07.99		<b>KF 300</b>
<b>KA 189</b>			E 300 TURBO D; E 320 CDI	130-145	12.96-03.02		<b>KF 124</b>
<b>KA 087</b>	CH. 7000560 -->		230 G; 230 GE; 280 GE	66-115	03.79-07.93		<b>KA 126</b>
<b>KA 087</b>	CH. 7000560 -->		240 GD; 250 GD; 300 GD	53-83	03.79-07.93		<b>KA 126</b>
<b>G-KLASSE/CLASS (W461)</b>							
			230 GE	90-92	02.93-		<b>KA 126</b>
			250 GD; 290 GD/G 290 D; G 290 TD	68-88	02.90-		<b>KA 126</b>
<b>G-KLASSE/CLASS (W463)</b>							
			230 GE; 300 GE; 320 GE; G 320	93-158	09.89-		<b>KA 126</b>
			250 GD; 300 GD; 350 G TURBO D; 350 GD TD; G 300 TD	69-130	09.89-		<b>KA 126</b>
<b>HENSCHEL 2-T</b>							
<b>KA 027</b>			207 1.8	51	02.73-12.77		<b>KA 126</b>
<b>M-KLASSE/CLASS (W163)</b>							
<b>KF 280</b>			ML 230; ML 320 V6; ML 350; ML 430; ML 500; ML 55 AMG	110-255	02.98-06.05		<b>KF 280</b>
<b>KF 280</b>			ML 270 CDI; ML 400 CDI	120-184	12.99-06.05		<b>KF 280</b>
<b>S-KLASSE/CLASS (W116)</b>							
<b>KA 027</b>	<b>ABS</b>		280 S; 280 SE,SEL; 350 SE,SEL; 450 SE,SEL; 450 SEL 6.9	115-210	08.72-07.80		<b>KA 026</b>
<b>S-KLASSE/CLASS (C/W126)</b>							
<b>KA 027</b>	<b>ABS</b>		260 SE	118-122	09.85-06.91		<b>KA 026</b>
<b>KA 029</b>	<b>ABS</b>		280 S; 280 SE,SEL; 300 SE,SEL; 380 SE,SEL; 380 SEC	115-160	10.79-06.91		<b>KA 026</b>
<b>KA 027</b>	<b>ABS</b>		280 S; 280 SE,SEL; 300 SE,SEL; 380 SE,SEL; 380 SEC	115-160	10.79-06.91		<b>KA 026</b>
<b>KA 029</b>	<b>ABS</b>		420 SE,SEL; 420 SEC; 500 SE,SEL; 500 SEC; 560 SE,SEL; 560 SEC	150-220	12.79-06.91		<b>KA 026</b>
<b>S-KLASSE/CLASS (C/W140)</b>							
			SEC/CL 420	205	10.94-02.99		<b>KF 300</b>
			400 SE,SEL/S420	210	02.91-10.98	CH. A212245 -->	<b>KF 300</b>
			500 SE,SEL; S 600	240-290	02.91-10.98	CH. A212245 -->	<b>KF 300</b>
			600 SE,SEL	300	04.91-12.92	CH. A212245 -->	<b>KF 300</b>
			S 300 TURBO D; S 350 TURBO D	110-130	01.93-10.98		<b>KF 300</b>
<b>S-KLASSE/CLASS (W220)</b>							
			S 280; S 320; S 430; S 500	150-225	10.98-08.05		<b>KF 300</b>
			S 500 4-matic; S 55 AMG	225-265	04.99-08.05		<b>KF 300</b>
			S 55 AMG	368	06.02-08.05		<b>KF 300</b>
			S 600	270	01.00-08.05		<b>KF 300</b>
			S 320 CDI	145	08.99-09.02		<b>KF 300</b>
			S 400 CDI	184	06.00-08.05		<b>KF 300</b>
<b>SL (C/R107)</b>							
<b>KA 025</b>			280 SL; 280 SLC	130-136	08.74-07.85		<b>KA 026</b>
<b>KA 028</b>			300 SL	132-138	09.85-08.89		<b>KA 026</b>
<b>KA 025</b>			350 SL; 350 SLC; 380 SL; 380 SLC	143-160	05.71-08.85		<b>KA 026</b>
<b>KA 028</b>			420 SL	150-160	01.86-08.89		<b>KA 026</b>
<b>KA 025</b>			450 SL; 450 SLC	160-165	10.72-10.80		<b>KA 026</b>
<b>KA 028</b>			500 SL	164-170	05.80-08.89		<b>KA 026</b>
<b>KA 025</b>			450 SLC 5.0	177	06.78-02.80		<b>KA 026</b>
<b>KA 028</b>			500 SL	177-180	05.80-08.89		<b>KA 026</b>

	<b>i</b>	<b>ENGINE</b>	<b>POWER (kW)</b>	<b>YEAR</b>	<b>i</b>	
Fersa KIT FRONT						Fersa KIT REAR
<b>MERCEDES BENZ</b>						
<b>SL (R129)</b>						
<b>KA 189</b>		280	142	08.93-10.01		<b>KF 124</b>
<b>KA 189</b>		300 SL; 300 SL-24; 320	140-170	03.89-10.01		<b>KF 124</b>
<b>KA 189</b>	--> 12.93	500	235	09.92-10.01	--> 12.93	<b>KF 124</b>
<b>KA 189</b>	01.94 -->	500	235	09.92-10.01	01.94 -->	<b>KF 124</b>
<b>KA 189</b>		500 SL	240	09.89-08.92		<b>KF 124</b>
<b>KA 189</b>	--> 12.93	600	290	07.92-10.01		
<b>KA 189</b>	01.94 -->	600	290	07.92-10.01		
		600	290	07.92-10.01		<b>KF 124</b>
<b>SLK (R170)</b>						
<b>KA 189</b>		200 Kompressor	120	03.00-04.04		
<b>MB</b>						
<b>KA 031</b>		100-130		85		
<b>KA 031</b>		140-150		85		
<b>KA 031</b>		170-180		85		
<b>SPRINTER 2-T (901,902)</b>						
<b>KA 273</b>		214; 214 NGT	92-105	02.95-05.06		
<b>KA 273</b>		208 CDI; 208 D; 210 D; 211 CDI; 212 D; 213 CDI; 216 CDI	58-115	01.95-05.06		
<b>SPRINTER 3-T (903)</b>						
<b>KA 273</b>	AXLE --> S231915	308 E; 314; 314 NGT	40-105	02.95-05.06		
<b>KA 273</b>	AXLE --> Y245976	308 E; 314; 314 NGT	40-105	02.95-05.06		
<b>KA 273</b>	AXLE --> S231915	308 CDI; 311 CDI; 313 CDI	60-95	04.00-05.06		
<b>KA 273</b>	AXLE --> Y245976	308 CDI; 311 CDI; 313 CDI	60-95	04.00-05.06		
<b>KA 273</b>	AXLE --> S231915	308 D	58-60	02.95-04.00		
<b>KA 273</b>	AXLE --> Y245976	308 D	58-60	02.95-04.00		
<b>KA 273</b>	AXLE --> S231915	316 CDI	115	04.00-05.06		
<b>KA 273</b>	AXLE --> Y245976	316 CDI	115	04.00-05.06		
<b>KA 273</b>	AXLE --> S231915	2.9 TDi; 310 D; 312 D	75-90	02.95-04.00		
<b>KA 273</b>	AXLE --> Y245976	2.9 TDi; 310 D; 312 D	75-90	02.95-04.00		
<b>SPRINTER 4-T (904)</b>						
<b>KA 273</b>		414; 414 4x4	105	02.96-05.06		
<b>KA 273</b>		2.3 D 4x4; 408 CDI; 408 D; 410 D; 410 D 4x4; 411 CDI; 411 CDI 4x4; 412 D; 412 D 4x4; 413 CDI; 413 CDI 4x4; 416 CDI; 416 CDI 4x4	58-115	02.96-05.06		
<b>T1 (601)</b>						
<b>KA 027</b>		208 2.3 Bus; 210 2.3 Bus; 210 2.3 Bus; 210 2.3 Platform	63-77	04.77-02.96		<b>KA 126</b>
<b>KA 027</b>		207 D 2.4 Bus; 207 D 2.4 Bus; 207 D 2.4 Platform; 208 D 2.3 Bus; 208 D 2.3 Bus; 208 D 2.3 Platform; 209 D 2.9 Bus; 209 D 3.0 Platform; 210 D 2.8 Bus; 210 D 2.8 Bus; 210 D 2.8 Platform; 210 D 2.9 Platform	48-72	04.77-02.96		<b>KA 126</b>
<b>T1 (602)</b>						
<b>KA 027</b>		308 D 2.3 Bus; 308 D 2.3 Bus; 308 D 2.3 Platform	58-60	11.88-02.96		<b>KA 126</b>
<b>KA 027</b>	<b>ABS</b>	307 D 2.4 Bus; 307 D 2.4 Platform	48-53	04.77-01.90		
<b>KA 273</b>	AXLE [730.405 / 730.407 / 730.447 / 730.448]	307 D 2.4 Bus; 307 D 2.4 Platform	48-53	04.77-01.90		<b>KA 126</b>
<b>KA 027</b>	<b>ABS</b>	310 D 2.9 Bus; 310 D 2.9 Bus	70	06.89-02.96		<b>KA 126</b>
<b>KA 273</b>		310 D 2.9 Platform	70	06.89-02.96		<b>KA 126</b>
<b>KA 027</b>	<b>ABS</b>	210 D 2.9 Bus; 210 D 2.9 Bus	72	06.89-02.96		<b>KA 126</b>
<b>KA 273</b>		310 D 2.9 Platform	72	06.89-02.96		<b>KA 126</b>
<b>KA 027</b>	<b>ABS</b>	309 D 3.0 Bus	65	10.82-01.90		<b>KA 126</b>
		309 D 3.0 Bus	65	10.82-01.90		<b>KA 126</b>
<b>KA 273</b>		309 D 3.0 Platform	65	10.82-01.90		<b>KA 126</b>

	<b>i</b>	ENGINE	POWER (kW)	YEAR	<b>i</b>	
Fersa KIT FRONT						Fersa KIT REAR
<b>MERCEDES BENZ</b>						
<b>VITO (638)</b>						
<b>KF 127</b>		113 2.0; 114 2.3	95-105	02.96-07.03		<b>KF 127</b>
<b>KF 127</b>		108 CDI 2.2; 108 D 2.3; 110 CDI 2.2; 110 D 2.3; 110 TD 2.3;	58-90	02.96-07.03		<b>KF 127</b>
<b>V-KLASSE/CLASS (6308.2)</b>						
<b>KF 127</b>		V 200; V 230; V 280	95-128	10.96-07.03		<b>KF 127</b>
<b>KF 127</b>		V 200 CDI; V 220 CDI; V 230 TD	72-90	09.96-07.03		<b>KF 127</b>
<b>MG</b>						
<b>ZR</b>						
<b>KF 099</b>		MG ZR	76-103	06.01-06.04		<b>KF 099</b>
<b>ZS</b>						
<b>KF 101</b>		MG ZS	86-117	07.01-01.06		<b>KF 101</b>
<b>MITSUBISHI</b>						
<b>CELESTE (A7_)</b>						
<b>KA 086</b>		1.6 ST (A73)	54	01.77-06.81		
<b>KA 086</b>		2.0 GSR (A78)	66-77	10.75-06.81		<b>KC 188</b>
<b>COLT I (A15_A)</b>						
		1.2 GL (A151A); 1.4 GLX,GT (A152A)	40-51	12.78-01.84		<b>KA 086</b>
<b>KA 022</b>		1.4 TURBO (A152A)	77	09.81-01.84		<b>KA 086</b>
<b>COLT II (C1_A)</b>						
<b>KA 022</b>		1.2 EL, GL (C15A); 1.5 GLX (C12A); 1.6 TURBO ECi (C13A)	40-92	02.84-04.88		<b>KA 187</b>
<b>KA 022</b>		1.8 GL D (C14A)	43-44	02.84-04.88		<b>KA 187</b>
<b>COLT III (C5_A)</b>						
<b>KA 022</b>		1.3 GL	44	04.88-12.90		
<b>KA 022</b>		1.3 (C51A); 1.3 12V (C51A); 1.5 (C52A); 1.5 GLXi (C52A)	51-66	04.88-05.92		
<b>KA 022</b>		1.6 GTi 16V (C53A); 1.8 GTi 16V (C58A)	91-100	04.88-05.92		
<b>KA 022</b>		1.8 D GLX (C54A)	44	04.88-05.92		
<b>COLT IV (CA_A)</b>						
<b>KF 119</b>	--> 12.94	1.3 GLi 12V (CA1A); 1.6; 1.6 GLXi 16V (CA4A); 1.8 GTi 16V (CA5A)	55-103	04.92-04.96		
		1.3 GLi 12V (CA1A); 1.6; 1.6 GLXi 16V (CA4A); 1.8 GTi 16V (CA5A)	55-103	04.92-04.96	--> 12.94 / DRUM BRAKE	<b>KV 120</b>
<b>COLT LANCER (A7_)</b>						
<b>KA 086</b>		1.2; 1.4	40-50	01.78-09.79		
<b>KA 086</b>		1.4 Estate Car; 1.6	50-60	01.78-09.79		<b>KC 188</b>
<b>COLT V (CJ_A)</b>						
<b>KF 119</b>	--> 11.98	1300 GL, GLX; 1500 (CJ2A); 1600 GLX	55-69	11.95-07.05		<b>KV 120</b>
<b>CORDIA (A21_A)</b>						
<b>KA 022</b>		1.6 GSL (A212A); 1.6 TURBO (A212A); 1.8 GSL (A215A);	55-100	10.82-12.86		<b>KA 086</b>
<b>GALANT I (A12_)</b>						
<b>KA 086</b>		1.6; 1.6 GL	55	01.77-08.80		<b>KC 188</b>
		2.0; 2.0 GLX	63-72	01.77-08.80		<b>KC 188</b>
<b>GALANT II (A16_)</b>						
<b>KA 086</b>		1.6 GLX (A161A) Limousine; 1.6 GLX (A161V) Estate Car	55	09.80-05.84		<b>KC 188</b>
		2.0 GLS (A163) Limousine; 2.0 GLX (A163V) Estate Car; 2.0 TURBO ECi (A164) Limousine	75-125	09.80-05.84		<b>KC 188</b>
		2.3 Turbo-D (A167) Limousine; 2.3 Turbo-D (A167V) Estate Car	62	09.80-05.84		<b>KC 188</b>
<b>GALANT III (E1_A)</b>						
<b>KF 317</b>		1.6 GLX (E11A); 2.0 GLS (E15A); 2.0 TURBO ECi (E15A); 2.4 GLS (E16A)	55-110	06.84-12.87		<b>KA 086</b>

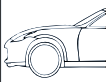
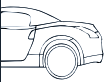
	<b>i</b>	<b>ENGINE</b>	<b>POWER (kW)</b>	<b>YEAR</b>	<b>i</b>	
Fersa KIT FRONT						Fersa KIT REAR
<b>MITSUBISHI</b>						
<b>GALANT III (E1_A)</b>						
<b>KF 317</b>		1.8 Turbo-D (E14A)	60	06.84-12.87		<b>KA 086</b>
<b>GALANT IV (E3_A)</b>						
<b>KF 121</b>		1.8 (E32A); 1.8 (E32A) Limousine	63-66	11.87-10.92	ABS	<b>KV 228</b>
<b>KF 121</b>		1.8 (E32A); 1.8 (E32A) Limousine	63-66	11.87-10.92		<b>KA 086</b>
<b>KF 121</b>		2.0 (E33A) Limousine; 2.0 (E33A) Hatchback; 2.0 (E38A) Limousine; 2.0 (E39A) Hatchback; 2.0 GTi 16V (E33A) Limousine; 2.0 GTi 16V (E33A) Hatchback	80-107	11.87-10.92		<b>KV 228</b>
<b>KF 121</b>		2.0 GTi 16V 4x4 Limousine; 2.0 GTi 16V 4x4 Hatchback	106-110	06.88-12.92		
<b>KF 121</b>		1.8 Turbo-D (E34A) Limousine; 1.8 Turbo-D (E34A) Hatchback	55	12.87-10.92		<b>KA 086</b>
<b>GALLOPER (JK-01)</b>						
<b>KA 190</b>		3.0 V6	104	02.99-		
<b>KA 190</b>		2.5 D	73	02.99-		
<b>KA 023</b>		2.5 D	51	11.86-08.96	--> 10.90	<b>KA 186</b>
<b>KA 190</b>		2.5 D 4WD	51	12.87-05.93	--> 10.90	<b>KA 186</b>
<b>KA 190</b>		2.5 TD 4WD	64	11.92-08.96		
<b>L 300 (L03_P/G,L0_2P)</b>						
<b>KA 023</b>		1.6 Bus; 1.6 Bus	48-51	05.80-02.87		
<b>KA 190</b>		1.8 4x4 Bus; 2.0 4x4 Bus	60-65	08.84-02.87		<b>KA 186</b>
<b>KA 023</b>		2.3 D Bus	50	04.83-10.86		
<b>KA 023</b>		2.5 D Platform	51	11.86-04.94		
<b>L 300 (P0_W,P1_W,P2_W)</b>						
<b>KA 023</b>	--> 12.96	1.6 Bus	51	11.86-		
<b>KA 023</b>		1.6 Bus	51	11.86-05.94		
<b>KA 023</b>	--> 12.96	2.0 Bus; 2.0 Bus	64-66	11.86-		
<b>KA 190</b>	--> 12.96	2.0 4WD Bus	65-66	11.86-		
		2.0 4WD Bus	65-66	11.86-	--> 10.90	<b>KA 186</b>
<b>KA 190</b>		2.3 4WD Bus	80	11.86-12.90		<b>KA 186</b>
<b>KA 023</b>	--> 12.96	2.4 Bus	82	11.90-		
<b>KA 190</b>	--> 12.96	2.4 4WD Bus	82	11.90-		
<b>KA 023</b>	--> 12.96	2.5 D Bus; 2.5 D Bus	51	11.86-		
<b>KA 190</b>	--> 12.96	2.5 D 4WD Bus	64	11.88-		
		2.5 D 4WD Bus	64	11.88-	--> 10.90	<b>KA 186</b>
<b>LANCER I (A17_)</b>						
<b>KA 086</b>		1.2	40	01.80-12.81		
<b>KA 086</b>		1.4 GLX; 1.6	50-62	09.79-02.83		<b>KC 188</b>
		2.0 TURBO Eci	125	03.81-02.83		<b>KC 188</b>
		1.2 GLX; 1.4 GLX; 1.4 TURBO	40-77	03.83-01.84		<b>KA 086</b>
<b>LANCER III (C1_A,C6_A,C1_V,C3_V)</b>						
<b>KA 022</b>		1.2 Limousine; 1.2 GL Limousine	40-44	01.84-04.88		<b>KA 187</b>
<b>KA 022</b>		1.5 GLX Limousine	51	06.85-04.88		<b>KA 187</b>
<b>KA 022</b>		1.5 Estate Car	51	09.85-08.89		<b>KA 086</b>
<b>KA 022</b>		1.5 GLX Limousine	55	11.83-04.88		<b>KA 187</b>
<b>KA 022</b>		1.5 Estate Car	55	09.85-12.87		<b>KA 086</b>
<b>KA 022</b>		1.5 Estate Car; 1.5 12V Estate Car; 1.8 4x4 Estate Car	61-69	01.87-06.92		<b>KA 086</b>
<b>KA 022</b>		1.8 D Limousine	43	01.84-09.86		<b>KA 187</b>
<b>KA 022</b>		1.8 D Estate Car	43	09.85-09.86		<b>KA 086</b>
<b>KA 022</b>		1.8 D Estate Car	44	08.86-06.92		<b>KA 086</b>
<b>KA 022</b>		1.8 D Limousine	44	09.86-04.88		<b>KA 187</b>
<b>LANCER IV (C6_A,C7_A)</b>						
<b>KA 022</b>		1.3; 1.3 12V; 1.5; 1.5 12V	44-66	04.88-05.94		

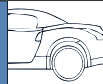
	<b>i</b>	ENGINE	POWER (kW)	YEAR	<b>i</b>	
Fersa KIT FRONT						Fersa KIT REAR
<b>MITSUBISHI</b>						
<b>LANCER IV (C6_A,C7_A)</b>						
<b>KF 119</b>		1.8 GTi 16V	103	06.92-12.93		
<b>KF 119</b>		1.8 GTi 16V	103	06.92-12.93		<b>KV 120</b>
<b>KA 022</b>		1.8 GTi 16V	100	11.89-05.92		
<b>KA 022</b>		1.8 D; 1.8 GLX D	44	04.88-05.92		
<b>LANCER V (CB/D_A,CB_W,CD_W)</b>						
<b>KF 119</b>	--> 12.94	1.3 Limousine; 1.6 Limousine; 1.6 16V Limousine	55-83	06.92-	--> 12.94 / DRUM BRAKE	<b>KV 120</b>
<b>KF 119</b>	--> 12.94	1.6 16V 4WD Limousine	83	06.92-	DRUM BRAKE	<b>KV 120</b>
<b>KF 119</b>	--> 12.94	2.0 D Limousine	50	06.92-	--> 12.94 / DRUM BRAKE	<b>KV 120</b>
<b>LANCER VI (CK/P_A)</b>						
<b>KF 119</b>		1.3 12V GL,GLX; 1.5 16V; 1.6 16V	55-69	12.95-08.03	DRUM BRAKE	<b>KV 120</b>
<b>PAJERO I (L04_G,L14_G)</b>						
<b>KA 190</b>		2.5; 3.0 V6	76-104	01.83-11.90		<b>KA 186</b>
<b>KA 190</b>		2.3 TD; 2.5 TD	62-70	12.82-12.91		<b>KA 186</b>
<b>PAJERO II (V2_W,V4_W)</b>						
<b>KA 190</b>		2.4; 3.0 V6; 3.0 V6 24V; 3.5 V6 24V; IO 1.8 GDI	82-153	12.90-04.00		<b>KA 186</b>
<b>KA 190</b>		2.5 TD; 2.8 TD	73-92	12.90-04.00		<b>KA 186</b>
<b>PAJERO PININ (H60)</b>						
<b>KA 190</b>		1.8 GDI	88	10.99-		<b>KA 186</b>
<b>PAJERO SPORT (K90)</b>						
<b>KA 190</b>		3.0 V6	130	11.98-		<b>KA 186</b>
<b>KA 190</b>		2.5 TD	73-85	11.98-		<b>KA 186</b>
<b>SAPORO I (A12_)</b>						
<b>KA 086</b>		1.6 SL,GL	55	04.78-07.80		<b>KC 188</b>
		2.0	72-79	04.78-07.80		<b>KC 188</b>
<b>SAPORO II (A16_A)</b>						
<b>KA 086</b>		1.6 GLX	55	08.80-09.84		<b>KC 188</b>
		2.0 GSL; 2.0 GSR; 2.0 TURBO Eci	75-125	08.80-09.84		<b>KC 188</b>
<b>SAPORO III (E16A)</b>						
<b>KA 022</b>		2.4	91	06.87-08.90		<b>KA 086</b>
<b>SPACE WAGON (D0_V/W)</b>						
<b>KA 022</b>		1.8 GLX	66	01.84-12.88		<b>KA 086</b>
<b>KF 317</b>		1.8 4x4	66	10.87-08.88		
<b>KA 022</b>		2.0 GLX	62	06.86-05.88		<b>KA 086</b>
<b>KF 317</b>		2.0 4x4; 2.0 GLX 4x4; 2.0 GLXi; 2.0 GLXi 4x4	62-75	03.85-04.91		
<b>KA 022</b>		1.8 TD	55	06.86-04.91		<b>KA 086</b>
<b>SPACE WAGON (N3_W,N4_W)</b>						
<b>KF 121</b>		1.8	90	10.91-10.98	ABS / DISC BRAKE	<b>KV 123</b>
<b>KF 121</b>		1.8	90	10.91-10.98	ABS / DRUM BRAKE	<b>KV 122</b>
<b>KF 121</b>		1.8 4x4	90	10.91-10.98		
<b>KF 121</b>		2.0 GLXi	98	10.92-10.98	ABS / DISC BRAKE	<b>KV 123</b>
<b>KF 121</b>		2.0 GLXi	98	10.92-10.98	ABS / DRUM BRAKE	<b>KV 122</b>
<b>KF 121</b>		2.0 GLXi 4x4	98	10.92-10.98		
<b>KF 121</b>		1.8 TD; 2.0 TD GLX	55-60	10.91-10.98	ABS / DISC BRAKE	<b>KV 123</b>
<b>KF 121</b>		1.8 TD; 2.0 TD GLX	55-60	10.91-10.98	ABS / DRUM BRAKE	<b>KV 122</b>
<b>TREDIA (A21_)</b>						
<b>KA 022</b>		1.4 GLX; 1.6 GLS; 1.6 TURBO; 1.8 GLS	51-85	09.82-10.87		<b>KA 086</b>
<b>NISSAN</b>						
<b>100 NX (B13)</b>						
<b>KF 130</b>		1.6; 1.6 SR; 2.0 GTi	66-105	03.90-10.94		

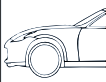
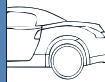
	<b>i</b>	ENGINE	POWER (kW)	YEAR	<b>i</b>	
Fersa KIT FRONT						Fersa KIT REAR
<b>NISSAN</b>						
<b>280 ZX,ZXT (HGS130)</b>						
<b>KA 036</b>		2.7	103-147	10.78-02.84		
<b>300 ZX (Z32)</b>						
<b>KF 318</b>		3.0 TWIN TURBO	197-208	05.90-09.95		
<b>ALMERA I (N15)</b>						
<b>KF 130</b>		1.4; 1.4 GX,LX; 1.4 S,GX,LX; 1.6; 1.6 SLX; 1.6 SR,SLX; 2.0 GTi	55-105	09.95-07.00		
<b>KF 130</b>		2.0 D	55	11.95-07.00		
<b>BLUEBIRD (910,W910)</b>						
		1.8	65-66	01.80-05.84		<b>KC 132</b>
		1.9i	80	01.82-05.84		<b>KC 132</b>
		1.9 D; 2.0 D	44	01.80-05.84		<b>KC 132</b>
<b>CHERRY (N10)</b>						
		1.0 Hatchback	32	08.78-07.81		<b>KA 077</b>
		1.2 Hatchback; 1.2 Coupe	38	08.78-07.81	01.79 -->	<b>KA 077</b>
		1.3 Hatchback; 1.3 Coupe	44	08.81-09.82		<b>KA 077</b>
		1.4 Hatchback; 1.4 Coupe; 1.5 Hatchback	51-59	08.80-12.82		<b>KA 077</b>
<b>CHERRY (N12)</b>						
		1.0; 1.3	37-44	05.82-10.86		<b>KA 077</b>
		1.5; 1.5 TURBO	55-77	01.83-10.86		<b>KA 077</b>
		1.7 D	40	10.82-12.86		<b>KA 077</b>
<b>CHERRY (VN10)</b>						
		1.2; 1.3; 1.4	38-59	10.78-12.83		<b>KA 077</b>
<b>DATSUN 120</b>						
		Y 1.2	38	09.74-07.80		<b>KC 132</b>
<b>L35</b>						
		L35				<b>KA 037</b>
<b>L45</b>						
		L45				<b>KA 037</b>
<b>LAUREL (HLC230)</b>						
<b>KA 036</b>		2.0; 2.4	71-83	03.77-05.83		<b>KC 132</b>
<b>LAUREL (JC31)</b>						
		2.0; 2.4	71-88	01.81-12.85		<b>KC 132</b>
		2.4	94	01.85-12.87		<b>KC 132</b>
		2.8 D	62	01.81-10.85		<b>KC 132</b>
		2.8 D	62-66	01.85-12.89		<b>KC 132</b>
<b>MAXIMA (J30)</b>						
<b>KF 128</b>		3.0i	125	10.88-06.94		
<b>MAXIMA QX (A32)</b>						
<b>KF 128</b>		2.0 QX; 3.0 QX	103-142	01.95-08.00		
<b>MICRA (K10)</b>						
		1.0	37-43	12.82-05.91	--> 10.88	<b>KA 034</b>
		1.0	37-43	12.82-05.91	11.88 -->	<b>KV 267</b>
		1.2	40-44	07.86-07.92		<b>KV 267</b>
<b>MICRA (K11)</b>						
<b>KF 321</b>		1.0i 16V; 1.3i 16V	40-55	08.92-09.00		
		1.0i 16V; 1.3i 16V	40-55	08.92-09.00	ABS / -->08.98	<b>KV 267</b>
<b>MICRA (K12)</b>						
<b>KF 351</b>		1.0 16V; 1.2 16V; 1.4 16V	48-65	01.03-		
<b>KF 351</b>		1.5 dCi	48-60	01.03-		
<b>PATROL (K160,W160)</b>						
<b>KA 035</b>		2.7	88-89	07.80-08.88		<b>KA 268</b>

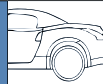
	<b>i</b>	ENGINE	POWER (kW)	YEAR	<b>i</b>	
Fersa KIT FRONT						Fersa KIT REAR
<b>NISSAN</b>						
<b>PATROL (K160,W160)</b>						
KA 035		2.7	88-89	07.80-08.88		KA 131
KA 035		3.2 D; 3.2 TD	70-81	11.79-08.88		KA 268
KA 035		3.2 D; 3.2 TD	70-81	11.79-08.88		KA 131
<b>PATROL (W160)</b>						
KA 035		2.7	88	07.80-08.88		KA 268
KA 035		2.7	88	07.80-08.88		KA 131
KA 035		3.2 D; 3.2 TD	70-81	11.79-08.88		KA 268
KA 035		3.2 D; 3.2 TD	70-81	11.79-08.88		KA 131
<b>PICK-UP (D21)</b>						
		2.4i 4WD	74	03.86-04.92		KA 266
		2.5 D 4WD	53-55	09.85-08.91		KA 266
		2.5 D	55	09.87-02.98		KA 266
		2.5 D 4WD	59	08.87-02.98		KA 266
		2.7 D 4WD	58	09.87-08.91		KA 266
		2.7 TD 4WD	73	08.87-02.98		KA 266
<b>PRAIRIE (M10,NM10)</b>						
		1.5 S; 1.8 SGL	55-66	07.83-12.87		KA 077
<b>PRAIRIE (M11)</b>						
		2.0,2.3	55-66	10.88-03.94		KF 128
		2.0,2.3, 4X4	55-66	10.88-03.94		KF 128
<b>PRIMERA (P10,W10)</b>						
KF 128	--> 05.95	1.6 Limousine; 1.6 Hatchback	66	06.90-01.96		
KF 128	--> 05.95	1.6 Limousine	71	06.90-01.96		
KF 128		1.6 Hatchback	71	06.90-06.93		
KF 128	--> 05.95	1.6 Hatchback	75	06.93-01.96		
KF 128	--> 05.95	2.0 16V Limousine; 2.0 16V Hatchback	85	06.90-01.96		
KF 128	--> 05.95	2.0 GT Limousine	110	06.90-01.96		
KF 128	--> 05.95	2.0 D Limousine; 2.0 D Hatchback	55	01.91-01.96		
<b>SILVIA (S110)</b>						
KA 036	01.80 -->	1.8 TURBO	68	01.79-05.83	01.80 -->	KC 132
<b>SILVIA (S12)</b>						
		2.0 GP	107	04.84-09.88		KC 132
<b>SUNNY (140Y,150Y)</b>						
		1.4 (HLB 310); 1.4 (HLB310); 1.5 (HLB 310); 1.5 (HLB310)	48-51	01.70-02.82		KC 132
<b>SUNNY I (B11)</b>						
		1.3	44	03.82-09.87		KA 077
		1.5	55	03.82-10.86		KA 077
		1.7 D	40	03.82-10.86		KA 077
<b>SUNNY II (B12)</b>						
KF 129		1.5; 1.6; 1.6i; 1.6i 12V	52-66	06.86-06.91		KB 217
KF 129		1.6i 12V 4x4	66	10.88-08.90		
KF 129		1.6i 4x4	54	06.86-05.89		
KF 129		1.6i	54	08.86-05.89		KB 217
KF 129		1.6 GTi 16V	81	05.87-05.89		
KF 129		1.8 GTi 16V	92	01.89-06.91		
KF 129		1.7 D	40	01.86-06.91		KB 217
<b>SUNNY II (N13)</b>						
KF 129		1.3; 1.4 LX; 1.5; 1.6; 1.6i; 1.6i 12V	44-66	06.86-10.91		KB 217
KF 129		1.6i 4x4	54	06.86-10.90		
KF 129		1.6 GTi 16V; 1.8 GTi 16V	81-92	02.87-06.91		





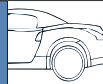

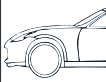
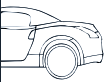
	<b>i</b>	ENGINE	POWER (kW)	YEAR	<b>i</b>	
Fersa KIT FRONT						Fersa KIT REAR
<b>NISSAN</b>						
<b>SUNNY II (N13)</b>						
<b>KF 129</b>		1.7 D	40	06.86-01.91		<b>KB 217</b>
<b>SUNNY III (N14,Y10)</b>						
<b>KF 130</b>		1.4 16V Limousine; 1.4 16V Hatchback	55	10.90-05.95		
<b>KF 130</b>		1.4i 16V Hatchback	64	10.90-05.95		
<b>KF 130</b>		1.5 Hatchback; 1.6 16V Limousine; 1.6 16V Hatchback	51-66	10.90-05.95		
<b>KF 130</b>		1.6 16V 4x4 Estate Car	66	11.90-05.95		
<b>KF 130</b>		1.6 16V Estate Car	66	06.91-03.00		
<b>KF 130</b>		1.6i 16V 4WD Limousine; 1.6i 16V 4x4 Hatchback	66-75	10.90-05.95		<b>KF 130</b>
<b>KF 130</b>		1.6i 16V Limousine; 1.6i 16V Hatchback	75	10.92-05.95		
<b>KF 130</b>		1.6i 16V 4x4 Estate Car	75	10.92-03.00		
<b>KF 130</b>		2.0 GTi 16V Hatchback; 2.0i 16V Hatchback	105	10.90-05.95		
<b>KF 130</b>		2.0 GTi-R 4x4 Hatchback	162	10.90-05.95		<b>KF 130</b>
<b>KF 130</b>		2.0 D Limousine; 2.0 D Hatchback	55	10.90-05.95		
<b>KF 130</b>		2.0 D Estate Car	55	06.91-03.00		
<b>TERRANO I (WD21)</b>						
		2.4i 4WD	76	10.87-02.93		<b>KA 266</b>
		3.0i 4WD	109	01.90-12.95	--> 10.92	<b>KA 266</b>
		2.7 TD 4WD	73	02.89-02.96	--> 10.92	<b>KA 266</b>
<b>URVAN (E24)</b>						
		2.0 Bus	64	05.87-05.97	--> 10.92	<b>KA 266</b>
		2.4i Bus	74	05.89-09.93		<b>KA 266</b>
		2.3 D Bus	51	01.88-05.97	--> 10.92	<b>KA 266</b>
		2.5 D Bus	59	12.88-05.97	--> 10.92	<b>KA 266</b>
		2.5 D Bus	59	05.89-10.96		<b>KA 266</b>
<b>VANETTE (KC120)</b>						
		1.5	51	01.83-12.87		<b>KC 132</b>
<b>VANETTE (C22)</b>						
		2.4i	74-77	10.86-12.95		<b>KC 132</b>
		2.0 D	47-49	10.86-12.95		<b>KC 132</b>
<b>OPEL</b>						
<b>AGILA</b>						
<b>KF 342</b>		1.0; 1.0i 12V; 1.2 16V Twinport; 1.2i 16V	43-59	09.00-		<b>KF 341</b>
<b>KF 319</b>		1.3 CDTI	51	08.03-		<b>KF 341</b>
<b>ARENA</b>						
		1.9 D Bus	44	03.98-08.01	<b>ABS</b>	<b>KA 269</b>
		1.9 D Bus	44	03.98-08.01	<b>ABS</b>	<b>KA 269</b>
		2.5 D Bus; 2.5 D Bus	55	03.98-08.01	<b>ABS</b>	<b>KA 269</b>
<b>ASCONA A</b>						
<b>KA 040</b>		1.2 S Limousine; 1.6 N Limousine; 1.6 N Estate Car; 1.6 S Limousine; 1.6 S Estate Car;	44-66	10.70-08.75		
<b>ASCONA B</b>						
<b>KA 007</b>		1.2; 1.2 S; 1.3 N; 1.3 S; 1.6 N; 1.6 S; 1.9 N; 1.9 S; 2.0 E; 2.0 N; 2.0 S	40-81	09.75-08.81		
<b>KA 038</b>		1.2; 1.2 S; 1.3 N; 1.3 S; 1.6 N; 1.6 S; 1.9 N; 1.9 S; 2.0 E; 2.0 N; 2.0 S	40-81	09.75-08.81		
<b>KA 007</b>		2.0 D	43	08.78-08.81		
<b>KA 038</b>		2.0 D	43	08.78-08.81		

	<b>i</b>	<b>ENGINE</b>	<b>POWER (kW)</b>	<b>YEAR</b>	<b>i</b>	
Fersa KIT FRONT						Fersa KIT REAR
<b>OPEL</b>						
<b>ASCONA C</b>						
<b>KF 133</b>		1.3 N; 1.3 S; 1.6	44-55	09.81-08.88		<b>KA 007</b>
<b>KF 134</b>		1.3 N; 1.3 S; 1.6	44-55	09.81-08.88		<b>KA 007</b>
<b>KF 133</b>		1.3 N; 1.3 S; 1.6	44-55	09.81-08.88		<b>KA 038</b>
<b>KF 133</b>		1.6i	55	09.86-08.88		<b>KA 007</b>
<b>KF 134</b>		1.6i	55	09.86-08.88		<b>KA 038</b>
<b>KF 133</b>		1.6; 1.6 S	60-66	09.81-08.88		<b>KA 007</b>
<b>KF 134</b>		1.6; 1.6 S	60-66	09.81-08.88		<b>KA 007</b>
<b>KF 134</b>	<b>ABS</b>	1.8; 1.8 E; 1.8i; 2.0i; 2.0i GT	62-95	09.82-08.88		<b>KA 007</b>
<b>KF 134</b>	<b>ABS</b>	1.8; 1.8 E; 1.8i; 2.0i; 2.0i GT	62-95	09.82-08.88		<b>KA 038</b>
<b>KF 134</b>	<b>ABS</b>	1.6 D	40	03.82-08.88		<b>KA 007</b>
<b>ASTRA F</b>						
		1.8	66	89-92		<b>KA 038</b>
		1.9,2.5 D	66	91-98		<b>KA 038</b>
		1.7 D, TD	66	91-98		<b>KA 038</b>
<b>KF 137</b>		1.4 Comfort	66	09.03-01.05		
		1.4 Comfort	66	09.03-01.05	<b>ABS</b>	<b>KV 202</b>
		1.4 Comfort	66	09.03-01.05	<b>ABS</b>	<b>KV 235</b>
<b>KF 133</b>	CH. --> P*999999	1.4i Limousine; 1.4i Hatchback; 1.4i Estate Car; 1.4i Saloon Car	44	09.91-01.99	<b>ABS</b>	<b>KV 202</b>
<b>KF 137</b>	CH. R*000001 -->	1.4i Limousine; 1.4i Hatchback; 1.4i Estate Car; 1.4i Saloon Car	44	09.91-01.99	<b>ABS</b>	<b>KV 235</b>
<b>KF 133</b>	CH. --> P*999999	1.4i Limousine; 1.4i Hatchback; 1.4i Estate Car; 1.4i Saloon Car	44	09.91-01.99	<b>ABS</b>	<b>KV 235</b>
<b>KF 137</b>	CH. R*000001 -->	1.4i Limousine; 1.4i Hatchback; 1.4i Estate Car; 1.4i Saloon Car	44	09.91-01.99	<b>ABS</b>	<b>KV 202</b>
<b>KF 137</b>		1.4i Limousine; 1.4i Hatchback; 1.4i Estate Car	44	01.98-01.05	<b>ABS</b>	<b>KV 202</b>
<b>KF 137</b>		1.4i Limousine; 1.4i Hatchback; 1.4i Estate Car	44	01.98-01.05	<b>ABS</b>	<b>KV 235</b>
<b>KF 133</b>	CH. --> P*999999	1.4 Limousine; 1.4 Hatchback; 1.4 Estate Car	55	09.91-09.93	<b>ABS</b>	<b>KV 235</b>
<b>KF 137</b>	CH. R*000001 -->	1.4 Limousine; 1.4 Hatchback; 1.4 Estate Car	55	09.91-09.93	<b>ABS</b>	<b>KV 202</b>
<b>KF 133</b>	CH. --> P*999999	1.4 Limousine; 1.4 Hatchback; 1.4 Estate Car	55	09.91-09.93	<b>ABS</b>	<b>KV 202</b>
<b>KF 137</b>	CH. R*000001 -->	1.4 Limousine; 1.4 Hatchback; 1.4 Estate Car	55	09.91-09.93	<b>ABS</b>	<b>KV 235</b>
<b>KF 133</b>	CH. --> P*999999 / [A.T]	1.4 Limousine; 1.4 Hatchback; 1.4 Estate Car; 1.4i Limousine	60	03.92-09.98	<b>ABS</b>	<b>KV 202</b>
<b>KF 133</b>	CH. P5077914 --> / CH. --> NE299999	1.4 Limousine; 1.4 Hatchback; 1.4 Estate Car; 1.4i Limousine	60	03.92-09.98	<b>ABS</b>	<b>KV 202</b>
<b>KF 134</b>	CH. --> P*999999 / [M.T]	1.4 Limousine; 1.4 Hatchback; 1.4 Estate Car; 1.4i Limousine	60	03.92-09.98	<b>ABS</b>	<b>KV 202</b>
<b>KF 134</b>	CH. --> P*999999	1.4 Limousine; 1.4 Hatchback; 1.4 Estate Car; 1.4i Limousine	60	03.92-09.98	<b>ABS</b>	<b>KV 202</b>
<b>KF 134</b>	CH. --> P*999999	1.4 Limousine; 1.4 Hatchback; 1.4 Estate Car; 1.4i Limousine	60	03.92-09.98	<b>ABS</b>	<b>KV 202</b>
<b>KF 137</b>	CH. R*000001 -->	1.4 Limousine; 1.4 Hatchback; 1.4 Estate Car; 1.4i Limousine	60	03.92-09.98	<b>ABS</b>	<b>KV 202</b>
<b>KF 133</b>	CH. --> P*999999 / [A.T]	1.4 Limousine; 1.4 Hatchback; 1.4 Estate Car; 1.4i Limousine	60	03.92-09.98	<b>ABS</b>	<b>KV 235</b>
<b>KF 133</b>	CH. P5077914 --> / CH. --> NE299999	1.4 Limousine; 1.4 Hatchback; 1.4 Estate Car; 1.4i Limousine	60	03.92-09.98	<b>ABS</b>	<b>KV 235</b>
<b>KF 134</b>	CH. --> P*999999 / [M.T]	1.4 Limousine; 1.4 Hatchback; 1.4 Estate Car; 1.4i Limousine	60	03.92-09.98	<b>ABS</b>	<b>KV 235</b>
<b>KF 134</b>	CH. --> P*999999	1.4 Limousine; 1.4 Hatchback; 1.4 Estate Car; 1.4i Limousine	60	03.92-09.98	<b>ABS</b>	<b>KV 235</b>
<b>KF 134</b>	CH. --> P*999999	1.4 Limousine; 1.4 Hatchback; 1.4 Estate Car; 1.4i Limousine	60	03.92-09.98	<b>ABS</b>	<b>KV 235</b>
<b>KF 137</b>	CH. R*000001 -->	1.4 Limousine; 1.4 Hatchback; 1.4 Estate Car; 1.4i Limousine	60	03.92-09.98	<b>ABS</b>	<b>KV 235</b>
<b>KF 133</b>	CH. --> P*999999 / [A.T]	1.4i S Hatchback; 1.4i S Estate Car	60	03.92-01.98	<b>ABS</b>	<b>KV 202</b>
<b>KF 133</b>	CH. P5077914 --> / CH. --> NE299999	1.4i S Hatchback; 1.4i S Estate Car	60	03.92-01.98	<b>ABS</b>	<b>KV 202</b>
<b>KF 134</b>	CH. --> P*999999 / [M.T]	1.4i S Hatchback; 1.4i S Estate Car	60	03.92-01.98	<b>ABS</b>	<b>KV 202</b>
<b>KF 134</b>	CH. --> P*999999	1.4i S Hatchback; 1.4i S Estate Car	60	03.92-01.98	<b>ABS</b>	<b>KV 202</b>
<b>KF 134</b>	CH. --> P*999999	1.4i S Hatchback; 1.4i S Estate Car	60	03.92-01.98	<b>ABS</b>	<b>KV 202</b>
<b>KF 137</b>	CH. R*000001 -->	1.4i S Hatchback; 1.4i S Estate Car	60	03.92-01.98	<b>ABS</b>	<b>KV 202</b>
<b>KF 133</b>	CH. --> P*999999 / [A.T]	1.4i S Hatchback; 1.4i S Estate Car	60	03.92-01.98	<b>ABS</b>	<b>KV 235</b>
<b>KF 133</b>	CH. P5077914 --> / CH. --> NE299999	1.4i S Hatchback; 1.4i S Estate Car	60	03.92-01.98	<b>ABS</b>	<b>KV 235</b>
<b>KF 134</b>	CH. --> P*999999 / [M.T]	1.4i S Hatchback; 1.4i S Estate Car	60	03.92-01.98	<b>ABS</b>	<b>KV 235</b>

 Fersa KIT FRONT	<b>i</b>	ENGINE	POWER (kW)	YEAR	<b>i</b>	Fersa KIT REAR 
<b>OPEL</b>						
<b>ASTRA F</b>						
<b>KF 134</b>	CH. --> P*999999	1.4i S Hatchback; 1.4i S Estate Car	60	03.92-01.98	<b>ABS</b>	<b>KV 235</b>
<b>KF 134</b>	CH. --> P*999999	1.4i S Hatchback; 1.4i S Estate Car	60	03.92-01.98	<b>ABS</b>	<b>KV 235</b>
<b>KF 137</b>	CH. R*000001 -->	1.4i S Hatchback; 1.4i S Estate Car	60	03.92-01.98	<b>ABS</b>	<b>KV 235</b>
<b>KF 133</b>	CH. P5077914 --> / CH. --> NE299999	1.4i Convertible	60	05.93-03.01	ABS	<b>KV 202</b>
<b>KF 134</b>	CH. --> RB000000	1.4i Convertible	60	05.93-03.01	ABS	<b>KV 202</b>
<b>KF 137</b>	CH. R*000001 -->	1.4i Convertible	60	05.93-03.01	ABS	<b>KV 202</b>
<b>KF 133</b>	CH. P5077914 --> / CH. --> NE299999	1.4i Convertible	60	05.93-03.01	<b>ABS</b>	<b>KV 235</b>
<b>KF 134</b>	CH. --> RB000000	1.4i Convertible	60	05.93-03.01	<b>ABS</b>	<b>KV 235</b>
<b>KF 137</b>	CH. R*000001 -->	1.4i Convertible	60	05.93-03.01	<b>ABS</b>	<b>KV 235</b>
<b>KF 137</b>		1.4i 16V Limousine; 1.4i 16V Hatchback; 1.4i 16V Estate Car; 1.4i 16V Convertible	66	01.96-03.01	ABS	<b>KV 202</b>
<b>KF 137</b>		1.4i 16V Limousine; 1.4i 16V Hatchback; 1.4i 16V Estate Car; 1.4i 16V Convertible	66	01.96-03.01	<b>ABS</b>	<b>KV 235</b>
<b>KF 134</b>	CH. --> P*999999 / [M.T]	1.6i Saloon Car; 1.6i Eco Limousine; 1.6i Eco Estate Car	52	02.93-07.96	ABS	<b>KV 202</b>
<b>KF 134</b>	CH. --> P*999999	1.6i Saloon Car; 1.6i Eco Limousine; 1.6i Eco Estate Car	52	02.93-07.96	ABS	<b>KV 202</b>
<b>KF 134</b>	CH. --> P*999999	1.6i Saloon Car; 1.6i Eco Limousine; 1.6i Eco Estate Car	52	02.93-07.96	ABS	<b>KV 202</b>
<b>KF 137</b>	CH. R*000001 -->	1.6i Saloon Car; 1.6i Eco Limousine; 1.6i Eco Estate Car	52	02.93-07.96	ABS	<b>KV 202</b>
<b>KF 134</b>	CH. --> P*999999 / [M.T]	1.6i Saloon Car; 1.6i Eco Limousine; 1.6i Eco Estate Car	52	02.93-07.96	<b>ABS</b>	<b>KV 235</b>
<b>KF 134</b>	CH. --> P*999999	1.6i Saloon Car; 1.6i Eco Limousine; 1.6i Eco Estate Car	52	02.93-07.96	<b>ABS</b>	<b>KV 235</b>
<b>KF 134</b>	CH. --> P*999999	1.6i Saloon Car; 1.6i Eco Limousine; 1.6i Eco Estate Car	52	02.93-07.96	<b>ABS</b>	<b>KV 235</b>
<b>KF 137</b>	CH. R*000001 -->	1.6i Saloon Car; 1.6i Eco Limousine; 1.6i Eco Estate Car	52	02.93-07.96	<b>ABS</b>	<b>KV 235</b>
<b>KF 134</b>	CH. --> RB000000	1.6i Eco Convertible	52	03.93-08.96	ABS	<b>KV 202</b>
<b>KF 137</b>	CH. R*000001 -->	1.6i Eco Convertible	52	03.93-08.96	ABS	<b>KV 202</b>
<b>KF 138</b>	CH. W2011158 --> / CH. W5013209 -->	1.6i Eco Convertible	52	03.93-08.96	ABS	<b>KV 202</b>
<b>KF 134</b>	CH. --> RB000000	1.6i Eco Convertible	52	03.93-08.96	<b>ABS</b>	<b>KV 235</b>
<b>KF 137</b>	CH. R*000001 -->	1.6i Eco Convertible	52	03.93-08.96	<b>ABS</b>	<b>KV 235</b>
<b>KF 138</b>	CH. W2011158 --> / CH. W5013209 -->	1.6i Eco Convertible	52	03.93-08.96	<b>ABS</b>	<b>KV 235</b>
<b>KF 133</b>	CH. --> P*999999 / [A.T]	1.6i Hatchback	52	05.93-07.96	ABS	<b>KV 202</b>
<b>KF 133</b>	CH. P5077914 --> / CH. --> NE299999	1.6i Hatchback	52	05.93-07.96	ABS	<b>KV 202</b>
<b>KF 134</b>	CH. --> P*999999 / [M.T]	1.6i Hatchback	52	05.93-07.96	ABS	<b>KV 202</b>
<b>KF 134</b>	CH. --> P*999999	1.6i Hatchback	52	05.93-07.96	ABS	<b>KV 202</b>
<b>KF 134</b>	CH. --> P*999999	1.6i Hatchback	52	05.93-07.96	ABS	<b>KV 202</b>
<b>KF 137</b>	CH. R*000001 -->	1.6i Hatchback	52	05.93-07.96	ABS	<b>KV 202</b>
<b>KF 133</b>	CH. --> P*999999 / [A.T]	1.6i Hatchback	52	05.93-07.96	<b>ABS</b>	<b>KV 235</b>
<b>KF 133</b>	CH. P5077914 --> / CH. --> NE299999	1.6i Hatchback	52	05.93-07.96	<b>ABS</b>	<b>KV 235</b>
<b>KF 134</b>	CH. --> P*999999 / [M.T]	1.6i Hatchback	52	05.93-07.96	<b>ABS</b>	<b>KV 235</b>
<b>KF 134</b>	CH. --> P*999999	1.6i Hatchback	52	05.93-07.96	<b>ABS</b>	<b>KV 235</b>
<b>KF 134</b>	CH. --> P*999999	1.6i Hatchback	52	05.93-07.96	<b>ABS</b>	<b>KV 235</b>
<b>KF 137</b>	CH. R*000001 -->	1.6i Hatchback	52	05.93-07.96	<b>ABS</b>	<b>KV 235</b>
<b>KF 133</b>	CH. --> P*999999 / [A.T]	1.6i Hatchback; 1.6i Estate Car	55	09.91-01.98	ABS	<b>KV 202</b>
<b>KF 133</b>	CH. P5077914 --> / CH. --> NE299999	1.6i Hatchback; 1.6i Estate Car	55	09.91-01.98	ABS	<b>KV 202</b>
<b>KF 134</b>	CH. --> P*999999 / [M.T]	1.6i Hatchback; 1.6i Estate Car	55	09.91-01.98	ABS	<b>KV 202</b>
<b>KF 134</b>	CH. --> P*999999	1.6i Hatchback; 1.6i Estate Car	55	09.91-01.98	ABS	<b>KV 202</b>
<b>KF 134</b>	CH. --> P*999999	1.6i Hatchback; 1.6i Estate Car	55	09.91-01.98	ABS	<b>KV 202</b>
<b>KF 137</b>	CH. R*000001 -->	1.6i Hatchback; 1.6i Estate Car	55	09.91-01.98	ABS	<b>KV 202</b>
<b>KF 133</b>	CH. --> P*999999 / [A.T]	1.6i Hatchback; 1.6i Estate Car	55	09.91-01.98	<b>ABS</b>	<b>KV 235</b>

Application for passenger cars

		ENGINE	POWER (kW)	YEAR		
Fersa KIT FRONT						Fersa KIT REAR
<b>OPEL</b>						
<b>ASTRA F</b>						
<b>KF 133</b>	CH. P5077914 --> / CH. --> NE299999	1.6i Hatchback; 1.6i Estate Car	55	09.91-01.98	<b>ABS</b>	<b>KV 235</b>
<b>KF 134</b>	CH. --> P*999999 / [M.T]	1.6i Hatchback; 1.6i Estate Car	55	09.91-01.98	<b>ABS</b>	<b>KV 235</b>
<b>KF 134</b>	CH. --> P*999999	1.6i Hatchback; 1.6i Estate Car	55	09.91-01.98	<b>ABS</b>	<b>KV 235</b>
<b>KF 134</b>	CH. --> P*999999	1.6i Hatchback; 1.6i Estate Car	55	09.91-01.98	<b>ABS</b>	<b>KV 235</b>
<b>KF 137</b>	CH. R*000001 -->	1.6i Hatchback; 1.6i Estate Car	55	09.91-01.98	<b>ABS</b>	<b>KV 235</b>
<b>KF 133</b>	CH. --> P*999999 / [A.T]	1.6i Saloon Car	55	10.91-04.93	<b>ABS</b>	<b>KV 202</b>
<b>KF 133</b>	CH. P5077914 --> / CH. --> NE299999	1.6i Saloon Car	55	10.91-04.93	<b>ABS</b>	<b>KV 202</b>
<b>KF 134</b>	CH. --> P*999999 / [M.T]	1.6i Saloon Car	55	10.91-04.93	<b>ABS</b>	<b>KV 202</b>
<b>KF 134</b>	CH. --> P*999999	1.6i Saloon Car	55	10.91-04.93	<b>ABS</b>	<b>KV 202</b>
<b>KF 134</b>	CH. --> P*999999	1.6i Saloon Car	55	10.91-04.93	<b>ABS</b>	<b>KV 202</b>
<b>KF 137</b>	CH. R*000001 -->	1.6i Saloon Car	55	10.91-04.93	<b>ABS</b>	<b>KV 202</b>
<b>KF 133</b>	CH. --> P*999999 / [A.T]	1.6i Saloon Car	55	10.91-04.93	<b>ABS</b>	<b>KV 235</b>
<b>KF 133</b>	CH. P5077914 --> / CH. --> NE299999	1.6i Saloon Car	55	10.91-04.93	<b>ABS</b>	<b>KV 235</b>
<b>KF 134</b>	CH. --> P*999999 / [M.T]	1.6i Saloon Car	55	10.91-04.93	<b>ABS</b>	<b>KV 235</b>
<b>KF 134</b>	CH. --> P*999999	1.6i Saloon Car	55	10.91-04.93	<b>ABS</b>	<b>KV 235</b>
<b>KF 134</b>	CH. --> P*999999	1.6i Saloon Car	55	10.91-04.93	<b>ABS</b>	<b>KV 235</b>
<b>KF 137</b>	CH. R*000001 -->	1.6i Saloon Car	55	10.91-04.93	<b>ABS</b>	<b>KV 235</b>
<b>KF 133</b>	CH. --> P*999999 / [A.T]	1.6i Limousine	55	03.92-08.94	<b>ABS</b>	<b>KV 202</b>
<b>KF 133</b>	CH. P5077914 --> / CH. --> NE299999	1.6i Limousine	55	03.92-08.94	<b>ABS</b>	<b>KV 202</b>
<b>KF 134</b>	CH. --> P*999999 / [M.T]	1.6i Limousine	55	03.92-08.94	<b>ABS</b>	<b>KV 202</b>
<b>KF 134</b>	CH. --> P*999999	1.6i Limousine	55	03.92-08.94	<b>ABS</b>	<b>KV 202</b>
<b>KF 134</b>	CH. --> P*999999	1.6i Limousine	55	03.92-08.94	<b>ABS</b>	<b>KV 202</b>
<b>KF 137</b>	CH. R*000001 -->	1.6i Limousine	55	03.92-08.94	<b>ABS</b>	<b>KV 202</b>
<b>KF 133</b>	CH. --> P*999999 / [A.T]	1.6i Limousine	55	03.92-08.94	<b>ABS</b>	<b>KV 235</b>
<b>KF 133</b>	CH. P5077914 --> / CH. --> NE299999	1.6i Limousine	55	03.92-08.94	<b>ABS</b>	<b>KV 235</b>
<b>KF 134</b>	CH. --> P*999999 / [M.T]	1.6i Limousine	55	03.92-08.94	<b>ABS</b>	<b>KV 235</b>
<b>KF 134</b>	CH. --> P*999999	1.6i Limousine	55	03.92-08.94	<b>ABS</b>	<b>KV 235</b>
<b>KF 134</b>	CH. --> P*999999	1.6i Limousine	55	03.92-08.94	<b>ABS</b>	<b>KV 235</b>
<b>KF 137</b>	CH. R*000001 -->	1.6i Limousine	55	03.92-08.94	<b>ABS</b>	<b>KV 235</b>
<b>KF 134</b>		1.6 Limousine	55	09.95-09.98	<b>ABS</b>	<b>KV 202</b>
<b>KF 137</b>		1.6 Limousine	55	09.95-09.98	<b>ABS</b>	<b>KV 202</b>
<b>KF 138</b>		1.6 Limousine	55	09.95-09.98	<b>ABS</b>	<b>KV 202</b>
<b>KF 134</b>		1.6 Limousine	55	09.95-09.98	<b>ABS</b>	<b>KV 235</b>
<b>KF 137</b>		1.6 Limousine	55	09.95-09.98	<b>ABS</b>	<b>KV 235</b>
<b>KF 138</b>		1.6 Limousine	55	09.95-09.98	<b>ABS</b>	<b>KV 235</b>
<b>KF 134</b>		1.6 Hatchback	55	09.95-01.98	<b>ABS</b>	<b>KV 202</b>
<b>KF 137</b>		1.6 Hatchback	55	09.95-01.98	<b>ABS</b>	<b>KV 202</b>
<b>KF 138</b>		1.6 Hatchback	55	09.95-01.98	<b>ABS</b>	<b>KV 202</b>
<b>KF 134</b>		1.6 Hatchback	55	09.95-01.98	<b>ABS</b>	<b>KV 235</b>
<b>KF 137</b>		1.6 Hatchback	55	09.95-01.98	<b>ABS</b>	<b>KV 235</b>
<b>KF 138</b>		1.6 Hatchback	55	09.95-01.98	<b>ABS</b>	<b>KV 235</b>
<b>KF 134</b>		1.6 Estate Car	55	09.95-01.98	<b>ABS</b>	<b>KV 202</b>
<b>KF 137</b>		1.6 Estate Car	55	09.95-01.98	<b>ABS</b>	<b>KV 202</b>
<b>KF 138</b>		1.6 Estate Car	55	09.95-01.98	<b>ABS</b>	<b>KV 202</b>
<b>KF 134</b>		1.6 Estate Car	55	09.95-01.98	<b>ABS</b>	<b>KV 235</b>
<b>KF 137</b>		1.6 Estate Car	55	09.95-01.98	<b>ABS</b>	<b>KV 235</b>
<b>KF 138</b>		1.6 Estate Car	55	09.95-01.98	<b>ABS</b>	<b>KV 235</b>

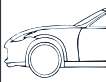
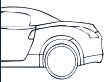
 Fersa KIT FRONT	<b>i</b>	ENGINE	POWER (kW)	YEAR	<b>i</b>	Fersa KIT REAR 
<b>OPEL</b>						
<b>ASTRA F</b>						
<b>KF 137</b>	CH. R*000001 -->	1.6i Convertible	55	01.96-03.01	ABS	<b>KV 202</b>
<b>KF 134</b>		1.6i Convertible	55	01.96-03.01	ABS	<b>KV 202</b>
<b>KF 138</b>	CH. W2011158 --> / CH. W5013209 -->	1.6i Convertible	55	01.96-03.01	ABS	<b>KV 202</b>
<b>KF 137</b>	CH. R*000001 -->	1.6i Convertible	55	01.96-03.01	<del>ABS</del>	<b>KV 235</b>
<b>KF 134</b>		1.6i Convertible	55	01.96-03.01	<del>ABS</del>	<b>KV 235</b>
<b>KF 138</b>	CH. W2011158 --> / CH. W5013209 -->	1.6i Convertible	55	01.96-03.01	<del>ABS</del>	<b>KV 235</b>
<b>KF 134</b>	CH. --> P*999999 / [M.T]	1.6i Limousine	55	08.96-09.98		
<b>KF 134</b>	CH. --> P*999999	1.6i Limousine	55	08.96-09.98		
<b>KF 134</b>	CH. --> P*999999	1.6i Limousine	55	08.96-09.98		
<b>KF 137</b>	CH. R*000001 -->	1.6i Limousine	55	08.96-09.98		
		1.6i Limousine	55	08.96-09.98	ABS	<b>KV 202</b>
		1.6i Limousine	55	08.96-09.98	<del>ABS</del>	<b>KV 235</b>
<b>KF 137</b>		1.6i Limousine; 1.6i Hatchback; 1.6i Estate Car	55	01.98-01.05		
	CH. P5077914 --> / CH. --> NE299999	1.6i Limousine; 1.6i Hatchback; 1.6i Estate Car	55	01.98-01.05	ABS	<b>KV 202</b>
		1.6i Limousine; 1.6i Hatchback; 1.6i Estate Car	55	01.98-01.05	<del>ABS</del>	<b>KV 235</b>
<b>KF 133</b>	CH. --> P*999999 / [A.T]	1.6 Si Hatchback; 1.6 Si Estate Car; 1.6i Limousine	74	03.92-12.94	ABS	<b>KV 202</b>
<b>KF 133</b>	CH. P5077914 --> / CH. --> NE299999	1.6 Si Hatchback; 1.6 Si Estate Car; 1.6i Limousine	74	03.92-12.94	ABS	<b>KV 202</b>
<b>KF 134</b>	CH. --> P*999999 / [M.T]	1.6 Si Hatchback; 1.6 Si Estate Car; 1.6i Limousine	74	03.92-12.94	ABS	<b>KV 202</b>
<b>KF 134</b>	CH. --> P*999999	1.6 Si Hatchback; 1.6 Si Estate Car; 1.6i Limousine	74	03.92-12.94	ABS	<b>KV 202</b>
<b>KF 134</b>	CH. --> P*999999	1.6 Si Hatchback; 1.6 Si Estate Car; 1.6i Limousine	74	03.92-12.94	ABS	<b>KV 202</b>
<b>KF 137</b>	CH. R*000001 -->	1.6 Si Hatchback; 1.6 Si Estate Car; 1.6i Limousine	74	03.92-12.94	ABS	<b>KV 202</b>
<b>KF 133</b>	CH. --> P*999999 / [A.T]	1.6 Si Hatchback; 1.6 Si Estate Car; 1.6i Limousine	74	03.92-12.94	<del>ABS</del>	<b>KV 235</b>
<b>KF 133</b>	CH. P5077914 --> / CH. --> NE299999	1.6 Si Hatchback; 1.6 Si Estate Car; 1.6i Limousine	74	03.92-12.94	<del>ABS</del>	<b>KV 235</b>
<b>KF 134</b>	CH. --> P*999999 / [M.T]	1.6 Si Hatchback; 1.6 Si Estate Car; 1.6i Limousine	74	03.92-12.94	<del>ABS</del>	<b>KV 235</b>
<b>KF 134</b>	CH. --> P*999999	1.6 Si Hatchback; 1.6 Si Estate Car; 1.6i Limousine	74	03.92-12.94	<del>ABS</del>	<b>KV 235</b>
<b>KF 134</b>	CH. --> P*999999	1.6 Si Hatchback; 1.6 Si Estate Car; 1.6i Limousine	74	03.92-12.94	<del>ABS</del>	<b>KV 235</b>
<b>KF 137</b>	CH. R*000001 -->	1.6 Si Hatchback; 1.6 Si Estate Car; 1.6i Limousine	74	03.92-12.94	<del>ABS</del>	<b>KV 235</b>
<b>KF 137</b>	ABS / CH. --> W5013208 / CH. --> W2011157	1.6i 16V Limousine	74	08.94-09.98	ABS	<b>KV 202</b>
<b>KF 138</b>	CH. W2011158 --> / CH. W5013209 --> / [M.T]	1.6i 16V Limousine	74	08.94-09.98	ABS	<b>KV 202</b>
<b>KF 137</b>	[A.T]	1.6i 16V Limousine	74	08.94-09.98	<del>ABS</del>	<b>KV 235</b>
<b>KF 137</b>	ABS / CH. --> W5013208 / CH. --> W2011157	1.6i 16V Limousine	74	08.94-09.98	<del>ABS</del>	<b>KV 235</b>
<b>KF 138</b>	CH. W2011158 --> / CH. W5013209 --> / [M.T]	1.6i 16V Limousine	74	08.94-09.98	<del>ABS</del>	<b>KV 235</b>
<b>KF 137</b>	[A.T]	1.6i 16V Hatchback	74	08.94-01.98	ABS	<b>KV 202</b>
<b>KF 137</b>	[A.T]	1.6i 16V Hatchback	74	08.94-01.98	<del>ABS</del>	<b>KV 235</b>
<b>KF 137</b>	[A.T]	1.6i 16V Estate Car	74	08.94-01.98	ABS	<b>KV 202</b>
<b>KF 137</b>	ABS / CH. --> W5013208 / CH. --> W2011157	1.6i 16V Estate Car	74	08.94-01.98	ABS	<b>KV 202</b>
<b>KF 138</b>	CH. W2011158 --> / CH. W5013209 --> / [M.T]	1.6i 16V Estate Car	74	08.94-01.98	ABS	<b>KV 202</b>
<b>KF 137</b>	[A.T]	1.6i 16V Estate Car	74	08.94-01.98	<del>ABS</del>	<b>KV 235</b>
<b>KF 137</b>	ABS / CH. --> W5013208 / CH. --> W2011157	1.6i 16V Estate Car	74	08.94-01.98	<del>ABS</del>	<b>KV 235</b>
<b>KF 138</b>	CH. W2011158 --> / CH. W5013209 --> / [M.T]	1.6i 16V Estate Car	74	08.94-01.98	<del>ABS</del>	<b>KV 235</b>
<b>KF 137</b>		1.6i 16V Limousine	74	01.98-08.02	ABS	<b>KV 202</b>
<b>KF 137</b>		1.6i 16V Limousine	74	01.98-08.02	<del>ABS</del>	<b>KV 235</b>

		ENGINE	POWER (kW)	YEAR		
Fersa KIT FRONT						Fersa KIT REAR
<b>OPEL</b>						
<b>ASTRA F</b>						
<b>KF 137</b>		1.6i 16V Hatchback	74	01.98-08.02	ABS	<b>KV 202</b>
<b>KF 137</b>		1.6i 16V Hatchback	74	01.98-08.02	<del>ABS</del>	<b>KV 235</b>
<b>KF 137</b>		1.6i 16V Estate Car	74	01.98-01.05	ABS	<b>KV 202</b>
<b>KF 137</b>		1.6i 16V Estate Car	74	01.98-01.05	<del>ABS</del>	<b>KV 235</b>
<b>KF 134</b>	CH. --> S*999999	1.8i Limousine; 1.8i Hatchback; 1.8i Estate Car	66	09.91-09.98	ABS	<b>KV 202</b>
<b>KF 138</b>	CH. T2500001 --> / CH. T*000001 -->	1.8i Limousine; 1.8i Hatchback; 1.8i Estate Car	66	09.91-09.98	ABS	<b>KV 202</b>
<b>KF 134</b>	CH. --> S*999999	1.8i Limousine; 1.8i Hatchback; 1.8i Estate Car	66	09.91-09.98	<del>ABS</del>	<b>KV 235</b>
<b>KF 138</b>	CH. T2500001 --> / CH. T*000001 -->	1.8i Limousine; 1.8i Hatchback; 1.8i Estate Car	66	09.91-09.98	<del>ABS</del>	<b>KV 235</b>
<b>KF 134</b>	CH. --> S*999999	1.8i 16V Hatchback; 1.8i 16V Estate Car	85	07.94-01.98	ABS	<b>KV 202</b>
<b>KF 138</b>	CH. T2500001 --> / CH. T*000001 -->	1.8i 16V Hatchback; 1.8i 16V Estate Car	85	07.94-01.98	ABS	<b>KV 202</b>
<b>KF 134</b>	CH. --> S*999999	1.8i 16V Hatchback; 1.8i 16V Estate Car	85	07.94-01.98	<del>ABS</del>	<b>KV 235</b>
<b>KF 138</b>	CH. T2500001 --> / CH. T*000001 -->	1.8i 16V Hatchback; 1.8i 16V Estate Car	85	07.94-01.98	<del>ABS</del>	<b>KV 235</b>
<b>KF 134</b>	CH. --> S*999999	1.8i 16V Limousine	85	11.94-09.98	ABS	<b>KV 202</b>
<b>KF 138</b>	CH. T2500001 --> / CH. T*000001 -->	1.8i 16V Limousine	85	11.94-09.98	ABS	<b>KV 202</b>
<b>KF 138</b>	CH. V*000001 -->	1.8i 16V Limousine	85	11.94-09.98	ABS	<b>KV 202</b>
<b>KF 134</b>	CH. --> S*999999	1.8i 16V Limousine	85	11.94-09.98	<del>ABS</del>	<b>KV 235</b>
<b>KF 138</b>	CH. T2500001 --> / CH. T*000001 -->	1.8i 16V Limousine	85	11.94-09.98	<del>ABS</del>	<b>KV 235</b>
<b>KF 138</b>	CH. V*000001 -->	1.8i 16V Limousine	85	11.94-09.98	<del>ABS</del>	<b>KV 235</b>
<b>KF 134</b>	CH. --> S*999999	1.8i 16V Convertible	85	11.94-03.01	ABS	<b>KV 202</b>
<b>KF 138</b>	CH. T2500001 --> / CH. T*000001 -->	1.8i 16V Convertible	85	11.94-03.01	ABS	<b>KV 202</b>
<b>KF 134</b>	CH. --> S*999999	1.8i 16V Convertible	85	11.94-03.01	<del>ABS</del>	<b>KV 235</b>
<b>KF 138</b>	CH. T2500001 --> / CH. T*000001 -->	1.8i 16V Convertible	85	11.94-03.01	<del>ABS</del>	<b>KV 235</b>
<b>KF 134</b>	CH. --> S*999999	1.8i 16V Limousine; 1.8i 16V Hatchback; 1.8i 16V Estate Car; 2.0 GSi 16V Hatchback; 2.0i [0]; 2.0i Limousine; 2.0i Hatchback; 2.0i Estate Car; 2.0i 16V Limousine; 2.0i 16V Hatchback; 2.0i 16V Estate Car	85-110	09.91-09.98	ABS	<b>KV 202</b>
<b>KF 138</b>	CH. T2500001 --> / CH. T*000001 -->	1.8i 16V Limousine; 1.8i 16V Hatchback; 1.8i 16V Estate Car; 2.0 GSi 16V Hatchback; 2.0i [0]; 2.0i Limousine; 2.0i Hatchback; 2.0i Estate Car; 2.0i 16V Limousine; 2.0i 16V Hatchback; 2.0i 16V Estate Car	85-110	09.91-09.98	ABS	<b>KV 202</b>
<b>KF 134</b>	CH. --> S*999999	1.8i 16V Limousine; 1.8i 16V Hatchback; 1.8i 16V Estate Car; 2.0 GSi 16V Hatchback; 2.0i [0]; 2.0i Limousine; 2.0i Hatchback; 2.0i Estate Car; 2.0i 16V Limousine; 2.0i 16V Hatchback; 2.0i 16V Estate Car	85-110	09.91-09.98	<del>ABS</del>	<b>KV 235</b>
<b>KF 138</b>	CH. T2500001 --> / CH. T*000001 -->	1.8i 16V Limousine; 1.8i 16V Hatchback; 1.8i 16V Estate Car; 2.0 GSi 16V Hatchback; 2.0i [0]; 2.0i Limousine; 2.0i Hatchback; 2.0i Estate Car; 2.0i 16V Limousine; 2.0i 16V Hatchback; 2.0i 16V Estate Car	85-110	09.91-09.98	<del>ABS</del>	<b>KV 235</b>
<b>KF 134</b>	CH. --> S*999999	1.7 D Limousine; 1.7 D Hatchback; 1.7 D Estate Car; 1.7 D Saloon Car; 1.7 TD Limousine; 1.7 TD Hatchback; 1.7 TD Estate Car; 1.7 TD Saloon Car; 1.7 TDS Limousine; 1.7 TDS Hatchback; 1.7 TDS Estate Car	42-60	12.91-01.99	ABS	<b>KV 202</b>
<b>KF 138</b>	CH. T2500001 --> / CH. T*000001 -->	1.7 D Limousine; 1.7 D Hatchback; 1.7 D Estate Car; 1.7 D Saloon Car; 1.7 TD Limousine; 1.7 TD Hatchback; 1.7 TD Estate Car; 1.7 TD Saloon Car; 1.7 TDS Limousine; 1.7 TDS Hatchback; 1.7 TDS Estate Car	42-60	12.91-01.99	ABS	<b>KV 202</b>
<b>KF 134</b>	CH. --> S*999999	1.7 D Limousine; 1.7 D Hatchback; 1.7 D Estate Car; 1.7 D Saloon Car; 1.7 TD Limousine; 1.7 TD Hatchback; 1.7 TD Estate Car; 1.7 TD Saloon Car; 1.7 TDS Limousine; 1.7 TDS Hatchback; 1.7 TDS Estate Car	42-60	12.91-01.99	<del>ABS</del>	<b>KV 235</b>
<b>KF 138</b>	CH. T2500001 --> / CH. T*000001 -->	1.7 D Limousine; 1.7 D Hatchback; 1.7 D Estate Car; 1.7 D Saloon Car; 1.7 TD Limousine; 1.7 TD Hatchback; 1.7 TD Estate Car; 1.7 TD Saloon Car; 1.7 TDS Limousine; 1.7 TDS Hatchback; 1.7 TDS Estate Car	42-60	12.91-01.99	<del>ABS</del>	<b>KV 235</b>

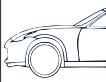
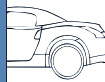
	<b>i</b>	<b>ENGINE</b>	<b>POWER (kW)</b>	<b>YEAR</b>	<b>i</b>	
Fersa KIT FRONT						Fersa KIT REAR
<b>OPEL</b>						
<b>ASTRA F</b>						
<b>KV 199</b>	ABS	1.2 16V; 1.4 16V; 1.6; 1.6 16V; 1.6 CNG; 1.8 16V; 2.0 16V; 2.0 16V OPC; 2.0 16V TURBO; 2.0 OPC; 2.2 16V	48-147	02.98-10.05	ABS	<b>KV 252</b>
<b>KV 198</b>	ABS	1.2 16V; 1.4 16V; 1.6; 1.6 16V; 1.6 CNG; 1.8 16V; 2.0 16V; 2.0 16V OPC; 2.0 16V TURBO; 2.0 OPC; 2.2 16V	48-147	02.98-10.05	ABS	<b>KV 202</b>
<b>KV 247</b>	ABS	1.2 16V; 1.4 16V; 1.6; 1.6 16V; 1.6 CNG; 1.8 16V; 2.0 16V; 2.0 16V OPC; 2.0 16V TURBO; 2.0 OPC; 2.2 16V	48-147	02.98-10.05	ABS	<b>KV 279</b>
<b>KV 196</b>	ABS	1.2 16V; 1.4 16V; 1.6; 1.6 16V; 1.6 CNG; 1.8 16V; 2.0 16V; 2.0 16V OPC; 2.0 16V TURBO; 2.0 OPC; 2.2 16V	48-147	02.98-10.05	ABS	<b>KV 235</b>
<b>KV 198</b>		1.2 16V; 1.4 16V; 1.6; 1.6 16V; 1.6 CNG; 1.8 16V; 2.0 16V; 2.0 16V OPC; 2.0 16V TURBO; 2.0 OPC; 2.2 16V	48-147	02.98-10.05	ABS	<b>KV 252</b>
<b>KV 199</b>		1.2 16V; 1.4 16V; 1.6; 1.6 16V; 1.6 CNG; 1.8 16V; 2.0 16V; 2.0 16V OPC; 2.0 16V TURBO; 2.0 OPC; 2.2 16V	48-147	02.98-10.05	ABS	<b>KV 202</b>
<b>KV 196</b>	ABS	1.2 16V; 1.4 16V; 1.6; 1.6 16V; 1.6 CNG; 1.8 16V; 2.0 16V; 2.0 16V OPC; 2.0 16V TURBO; 2.0 OPC; 2.2 16V	48-147	02.98-10.05	ABS	<b>KV 279</b>
<b>KV 247</b>	ABS	1.2 16V; 1.4 16V; 1.6; 1.6 16V; 1.6 CNG; 1.8 16V; 2.0 16V; 2.0 16V OPC; 2.0 16V TURBO; 2.0 OPC; 2.2 16V	48-147	02.98-10.05	ABS	<b>KV 235</b>
<b>KV 199</b>		1.7 CDTI; 1.7 DTI 16V Eco4; 1.7 TD; 2.0 DI Limousine; 2.0 DI Hatchback; 2.0 DI Estate Car; 2.0 DI Bus; 2.0 DTI 16V; 2.2 DTI	50-92	02.98-10.05	ABS	<b>KV 252</b>
<b>KV 198</b>		1.7 CDTI; 1.7 DTI 16V Eco4; 1.7 TD; 2.0 DI Limousine; 2.0 DI Hatchback; 2.0 DI Estate Car; 2.0 DI Bus; 2.0 DTI 16V; 2.2 DTI	50-92	02.98-10.05	ABS	<b>KV 202</b>
<b>KV 247</b>	ABS	1.7 CDTI; 1.7 DTI 16V Eco4; 1.7 TD; 2.0 DI Limousine; 2.0 DI Hatchback; 2.0 DI Estate Car; 2.0 DI Bus; 2.0 DTI 16V; 2.2 DTI	50-92	02.98-10.05	ABS	<b>KV 279</b>
<b>KV 196</b>	ABS	1.7 CDTI; 1.7 DTI 16V Eco4; 1.7 TD; 2.0 DI Limousine; 2.0 DI Hatchback; 2.0 DI Estate Car; 2.0 DI Bus; 2.0 DTI 16V; 2.2 DTI	50-92	02.98-10.05	ABS	<b>KV 235</b>
<b>KV 198</b>		1.7 CDTI; 1.7 DTI 16V Eco4; 1.7 TD; 2.0 DI Limousine; 2.0 DI Hatchback; 2.0 DI Estate Car; 2.0 DI Bus; 2.0 DTI 16V; 2.2 DTI	50-92	02.98-10.05	ABS	<b>KV 252</b>
<b>KV 199</b>		1.7 CDTI; 1.7 DTI 16V Eco4; 1.7 TD; 2.0 DI Limousine; 2.0 DI Hatchback; 2.0 DI Estate Car; 2.0 DI Bus; 2.0 DTI 16V; 2.2 DTI	50-92	02.98-10.05	ABS	<b>KV 202</b>
<b>KV 196</b>	ABS	1.7 CDTI; 1.7 DTI 16V Eco4; 1.7 TD; 2.0 DI Limousine; 2.0 DI Hatchback; 2.0 DI Estate Car; 2.0 DI Bus; 2.0 DTI 16V; 2.2 DTI	50-92	02.98-10.05	ABS	<b>KV 279</b>
<b>KV 247</b>	ABS	1.7 CDTI; 1.7 DTI 16V Eco4; 1.7 TD; 2.0 DI Limousine; 2.0 DI Hatchback; 2.0 DI Estate Car; 2.0 DI Bus; 2.0 DTI 16V; 2.2 DTI	50-92	02.98-10.05	ABS	<b>KV 235</b>
<b>KV 333</b>		1.4; 1.6; 1.6 Turbo; 1.8	59-132	03.04-	ABS	<b>KV 330</b>
<b>KV 332</b>		1.4; 1.6; 1.6 Turbo; 1.8	59-132	03.04-	ABS	<b>KV 331</b>
<b>KV 332</b>		1.4; 1.6; 1.6 Turbo; 1.8	59-132	03.04-	ABS	<b>KV 330</b>
<b>KV 333</b>		1.4; 1.6; 1.6 Turbo; 1.8	59-132	03.04-	ABS	<b>KV 331</b>
<b>ASTRA H</b>						
<b>KV 333</b>		2.0 Turbo	177	03.05-	ABS	<b>KV 330</b>
<b>KV 333</b>		2.0 Turbo	177	03.05-	ABS	<b>KV 331</b>
<b>KV 333</b>		1.3 CDTI; 1.7 CDTI	59-74	03.04-	ABS	<b>KV 330</b>
<b>KV 332</b>		1.3 CDTI; 1.7 CDTI	59-74	03.04-	ABS	<b>KV 331</b>
<b>KV 332</b>		1.3 CDTI; 1.7 CDTI	59-74	03.04-	ABS	<b>KV 330</b>
<b>KV 333</b>		1.3 CDTI; 1.7 CDTI	59-74	03.04-	ABS	<b>KV 331</b>
<b>KV 333</b>		1.7 CDTI	81-92	02.07-	ABS	<b>KV 330</b>
<b>KV 333</b>		1.7 CDTI	81-92	02.07-	ABS	<b>KV 331</b>
<b>KV 333</b>		1.9 CDTI	74-88	04.04-	ABS	<b>KV 330</b>
<b>KV 332</b>	CH. --> 62079978	1.9 CDTI	74-88	04.04-	ABS	<b>KV 330</b>
<b>KV 332</b>	CH. --> 65076709	1.9 CDTI	74-88	04.04-	ABS	<b>KV 330</b>
<b>KV 332</b>	CH. --> 68027072	1.9 CDTI	74-88	04.04-	ABS	<b>KV 330</b>
<b>KV 333</b>		1.9 CDTI	74-88	04.04-	ABS	<b>KV 331</b>
<b>KV 332</b>	CH. --> 62079978	1.9 CDTI	74-88	04.04-	ABS	<b>KV 331</b>

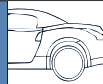

	<b>i</b>	<b>ENGINE</b>	<b>POWER (kW)</b>	<b>YEAR</b>	<b>i</b>	
Fersa KIT FRONT						Fersa KIT REAR
<b>OPEL</b>						
<b>ASTRA H</b>						
<b>KV 332</b>	CH. --> 65076709	1.9 CDTI	74-88	04.04-	<b>ABS</b>	<b>KV 331</b>
<b>KV 332</b>	CH. --> 68027072	1.9 CDTI	74-88	04.04-	<b>ABS</b>	<b>KV 331</b>
<b>KV 333</b>		1.9 CDTI	110	09.04-	<b>ABS</b>	<b>KV 330</b>
<b>KV 333</b>		1.9 CDTI	110	09.04-	<b>ABS</b>	<b>KV 331</b>
<b>KV 333</b>		2.0 Turbo	125-147	03.04-	<b>ABS</b>	<b>KV 330</b>
<b>KV 332</b>	CH. --> 62079978	2.0 Turbo	125-147	03.04-	<b>ABS</b>	<b>KV 330</b>
<b>KV 332</b>	CH. --> 65076709	2.0 Turbo	125-147	03.04-	<b>ABS</b>	<b>KV 330</b>
<b>KV 332</b>	CH. --> 68027072	2.0 Turbo	125-147	03.04-	<b>ABS</b>	<b>KV 330</b>
<b>KV 333</b>		2.0 Turbo	125-147	03.04-	<b>ABS</b>	<b>KV 331</b>
<b>KV 332</b>	CH. --> 62079978	2.0 Turbo	125-147	03.04-	<b>ABS</b>	<b>KV 331</b>
<b>KV 332</b>	CH. --> 65076709	2.0 Turbo	125-147	03.04-	<b>ABS</b>	<b>KV 331</b>
<b>KV 332</b>	CH. --> 68027072	2.0 Turbo	125-147	03.04-	<b>ABS</b>	<b>KV 331</b>
<b>ASTRA H CABRIOLET</b>						
<b>KV 333</b>		1.6; 1.6 Turbo; 1.8	77-132	09.05-	<b>ABS</b>	<b>KV 330</b>
<b>KV 332</b>		1.6; 1.6 Turbo; 1.8	77-132	09.05-	<b>ABS</b>	<b>KV 331</b>
<b>KV 332</b>		1.6; 1.6 Turbo; 1.8	77-132	09.05-	<b>ABS</b>	<b>KV 330</b>
<b>KV 333</b>		1.6; 1.6 Turbo; 1.8	77-132	09.05-	<b>ABS</b>	<b>KV 331</b>
<b>KV 333</b>		2.0 Turbo	125-147	09.05-	<b>ABS</b>	<b>KV 330</b>
<b>KV 332</b>	CH. --> 62079978	2.0 Turbo	125-147	09.05-	<b>ABS</b>	<b>KV 330</b>
<b>KV 332</b>	CH. --> 65076709	2.0 Turbo	125-147	09.05-	<b>ABS</b>	<b>KV 330</b>
<b>KV 332</b>	CH. --> 68027072	2.0 Turbo	125-147	09.05-	<b>ABS</b>	<b>KV 330</b>
<b>KV 333</b>		2.0 Turbo	125-147	09.05-	<b>ABS</b>	<b>KV 331</b>
<b>KV 332</b>	CH. --> 62079978	2.0 Turbo	125-147	09.05-	<b>ABS</b>	<b>KV 331</b>
<b>KV 332</b>	CH. --> 65076709	2.0 Turbo	125-147	09.05-	<b>ABS</b>	<b>KV 331</b>
<b>KV 332</b>	CH. --> 68027072	2.0 Turbo	125-147	09.05-	<b>ABS</b>	<b>KV 331</b>
<b>KV 333</b>		1.9 CDTi	110	09.05-	<b>ABS</b>	<b>KV 330</b>
<b>KV 333</b>		1.9 CDTi	110	09.05-	<b>ABS</b>	<b>KV 331</b>
<b>KV 333</b>		1.4; 1.6; 1.6 Turbo; 1.8	66-132	08.04-	<b>ABS</b>	<b>KV 330</b>
<b>KV 332</b>		1.4; 1.6; 1.6 Turbo; 1.8	66-132	08.04-	<b>ABS</b>	<b>KV 331</b>
<b>ASTRA H CARAVAN</b>						
<b>KV 333</b>		2.0 Turbo	125-147	08.04-	<b>ABS</b>	<b>KV 330</b>
<b>KV 332</b>	CH. --> 62079978	2.0 Turbo	125-147	08.04-	<b>ABS</b>	<b>KV 330</b>
<b>KV 332</b>	CH. --> 65076709	2.0 Turbo	125-147	08.04-	<b>ABS</b>	<b>KV 330</b>
<b>KV 332</b>	CH. --> 68027072	2.0 Turbo	125-147	08.04-	<b>ABS</b>	<b>KV 330</b>
<b>KV 333</b>		2.0 Turbo	125-147	08.04-	<b>ABS</b>	<b>KV 331</b>
<b>KV 332</b>	CH. --> 62079978	2.0 Turbo	125-147	08.04-	<b>ABS</b>	<b>KV 331</b>
<b>KV 332</b>	CH. --> 65076709	2.0 Turbo	125-147	08.04-	<b>ABS</b>	<b>KV 331</b>
<b>KV 332</b>	CH. --> 68027072	2.0 Turbo	125-147	08.04-	<b>ABS</b>	<b>KV 331</b>
<b>KV 333</b>		1.3 CDTI; 1.7 CDTI	59-74	08.04-		<b>KV 330</b>
<b>KV 332</b>		1.3 CDTI; 1.7 CDTI	59-74	08.04-		<b>KV 331</b>
<b>KV 332</b>		1.3 CDTI; 1.7 CDTI	59-74	08.04-		<b>KV 330</b>
<b>KV 333</b>		1.3 CDTI; 1.7 CDTI	59-74	08.04-		<b>KV 331</b>
<b>KV 333</b>		1.7 CDTI	81-92	02.07-		<b>KV 330</b>
<b>KV 333</b>		1.7 CDTI	81-92	02.07-		<b>KV 331</b>
<b>KV 333</b>		1.9 CDTI	74-88	08.04-		<b>KV 330</b>
<b>KV 332</b>	CH. --> 62079978	1.9 CDTI	74-88	08.04-		<b>KV 330</b>
<b>KV 332</b>	CH. --> 65076709	1.9 CDTI	74-88	08.04-		<b>KV 330</b>
<b>KV 332</b>	CH. --> 68027072	1.9 CDTI	74-88	08.04-		<b>KV 330</b>
<b>KV 333</b>		1.9 CDTI	74-88	08.04-		<b>KV 331</b>
<b>KV 332</b>	CH. --> 62079978	1.9 CDTI	74-88	08.04-		<b>KV 331</b>

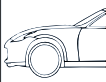
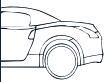
	<b>i</b>	<b>ENGINE</b>	<b>POWER (kW)</b>	<b>YEAR</b>	<b>i</b>	
Fersa KIT FRONT						Fersa KIT REAR
<b>OPEL</b>						
<b>ASTRA H CARAVAN</b>						
<b>KV 332</b>	CH. --> 65076709	1.9 CDTI	74-88	08.04-		<b>KV 331</b>
<b>KV 332</b>	CH. --> 68027072	1.9 CDTI	74-88	08.04-		<b>KV 331</b>
<b>KV 333</b>		1.9 CDTI	110	09.04-		<b>KV 330</b>
<b>KV 333</b>		1.9 CDTI	110	09.04-		<b>KV 331</b>
<b>ASTRA H GTC</b>						
<b>KV 333</b>		1.4; 1.6; 1.6 Turbo; 1.8	66-132	03.05-		<b>KV 330</b>
<b>KV 332</b>		1.4; 1.6; 1.6 Turbo; 1.8	66-132	03.05-		<b>KV 331</b>
<b>KV 332</b>		1.4; 1.6; 1.6 Turbo; 1.8	66-132	03.05-		<b>KV 330</b>
<b>KV 333</b>		1.4; 1.6; 1.6 Turbo; 1.8	66-132	03.05-		<b>KV 331</b>
<b>KV 333</b>		2.0 Turbo	125-147	03.05-		<b>KV 330</b>
<b>KV 332</b>	CH. --> 62079978	2.0 Turbo	125-147	03.05-		<b>KV 330</b>
<b>KV 332</b>	CH. --> 65076709	2.0 Turbo	125-147	03.05-		<b>KV 330</b>
<b>KV 332</b>	CH. --> 68027072	2.0 Turbo	125-147	03.05-		<b>KV 330</b>
<b>KV 333</b>		2.0 Turbo	125-147	03.05-		<b>KV 331</b>
<b>KV 332</b>	CH. --> 62079978	2.0 Turbo	125-147	03.05-		<b>KV 331</b>
<b>KV 332</b>	CH. --> 65076709	2.0 Turbo	125-147	03.05-		<b>KV 331</b>
<b>KV 332</b>	CH. --> 68027072	2.0 Turbo	125-147	03.05-		<b>KV 331</b>
<b>KV 333</b>		2.0 Turbo	177	08.05-		<b>KV 330</b>
<b>KV 333</b>		2.0 Turbo	177	08.05-		<b>KV 331</b>
<b>KV 333</b>		1.3 CDTi; 1.7 CDTi	66-74	03.05-		<b>KV 330</b>
<b>KV 332</b>		1.3 CDTi; 1.7 CDTi	66-74	03.05-		<b>KV 331</b>
<b>KV 332</b>		1.3 CDTi; 1.7 CDTi	66-74	03.05-		<b>KV 330</b>
<b>KV 333</b>		1.3 CDTi; 1.7 CDTi	66-74	03.05-		<b>KV 331</b>
<b>KV 333</b>		1.7 CDTi	81-92	02.07-		<b>KV 330</b>
<b>KV 333</b>		1.7 CDTi	81-92	02.07-		<b>KV 331</b>
<b>KV 333</b>		1.9 CDTi	74-88	03.05-		<b>KV 330</b>
<b>KV 332</b>	CH. --> 62079978	1.9 CDTi	74-88	03.05-		<b>KV 330</b>
<b>KV 332</b>	CH. --> 65076709	1.9 CDTi	74-88	03.05-		<b>KV 330</b>
<b>KV 332</b>	CH. --> 68027072	1.9 CDTi	74-88	03.05-		<b>KV 330</b>
<b>KV 333</b>		1.9 CDTi	74-88	03.05-		<b>KV 331</b>
<b>KV 332</b>	CH. --> 62079978	1.9 CDTi	74-88	03.05-		<b>KV 331</b>
<b>KV 332</b>	CH. --> 65076709	1.9 CDTi	74-88	03.05-		<b>KV 331</b>
<b>KV 332</b>	CH. --> 68027072	1.9 CDTi	74-88	03.05-		<b>KV 331</b>
<b>KV 333</b>		1.9 CDTi	110	03.05-		<b>KV 330</b>
<b>KV 333</b>		1.9 CDTi	110	03.05-		<b>KV 331</b>
<b>CALIBRA A</b>						
<b>KF 134</b>	--> 12.95	2.0i; 2.0i 16V	85-100	06.90-07.97		<b>KF 136</b>
<b>KF 138</b>	01.96 -->	2.0i; 2.0i 16V	85-100	06.90-07.97		<b>KF 136</b>
		2.0i; 2.0i 16V	85-100	06.90-07.97		<b>KF 136</b>
<b>KF 134</b>	--> 12.95	2.0i 16V 4x4; 2.0i 4x4	85-100	06.90-07.97		<b>KF 136</b>
<b>KF 138</b>	01.96 -->	2.0i 16V 4x4; 2.0i 4x4	85-100	06.90-07.97		<b>KF 136</b>
<b>KF 134</b>		2.0i 16V	110	06.90-02.94		<b>KF 136</b>
<b>KF 134</b>		2.0i 16V 4x4	110	06.90-02.94		<b>KF 136</b>
<b>KF 134</b>	--> 12.92	2.0i TURBO 4x4	150	03.92-07.97		<b>KF 136</b>
<b>KF 138</b>	01.93 -->	2.0i TURBO 4x4	150	03.92-07.97		<b>KF 136</b>
<b>KF 138</b>		2.5i V6	125	04.93-07.97		<b>KF 136</b>
<b>COMBO</b>						
<b>KF 137</b>		1.2; 1.4; 1.4 16V; 1.4i; 1.6; 1.6 16V	33-69	07.94-		<b>KA 039</b>
<b>KF 137</b>		1.3 CDTi 16V; 1.7 CDTi 16V; 1.7 D; 1.7 DI 16V; 1.7 DTi 16V	44-74	07.94-		<b>KA 039</b>

	<b>i</b>	ENGINE	POWER (kW)	YEAR	<b>i</b>	
Fersa KIT FRONT						Fersa KIT REAR
<b>OPEL</b>						
<b>COMMODORE C</b>						
<b>KA 039</b>	CH. 91362918 -->	2.5 S	85	08.78-12.82		
<b>KA 039</b>		2.5 E; 2.5 S	85-96	12.80-12.82		
<b>CORSA A</b>						
<b>KF 133</b>		1.0; 1.2; 1.2 N; 1.2 S; 1.2i; 1.3; 1.3 S; 1.3i; 1.4 S; 1.4i; 1.4i S; 1.6 GSi	33-74	09.82-03.93		<b>KA 007</b>
<b>KF 133</b>		1.5 D; 1.5 TD	37-49	06.87-03.93		<b>KA 007</b>
<b>CORSA B</b>						
<b>KF 137</b>		1.0i 12V; 1.2i; 1.2i 16V; 1.4 S; 1.4i; 1.4i 16V; 1.6 GSi 16V; 1.6i 16V	33-80	03.93-09.00		<b>KA 007</b>
<b>KF 137</b>		1.5 D; 1.5 TD; 1.7 D	37-49	03.93-09.00		<b>KA 007</b>
<b>CORSA C</b>						
<b>KF 292</b>		1.0; 1.0 12V; 1.2 16V; 1.2 Twinport	43-59	09.00-	DISC BRAKE	<b>KV 337</b>
<b>KF 292</b>		1.0; 1.0 12V; 1.2 16V; 1.2 Twinport	43-59	09.00-	DRUM BRAKE	<b>KB 338</b>
<b>KF 292</b>		1.4 Twinport	66	06.03-	DISC BRAKE	<b>KV 337</b>
<b>KF 292</b>		1.4 16V; 1.8 16V	66-92	09.00-	DISC BRAKE	<b>KV 337</b>
<b>KF 292</b>		1.4 16V; 1.8 16V	66-92	09.00-	DRUM BRAKE	<b>KB 338</b>
<b>KF 292</b>		1.3 CDTi; 1.3 CDTi 16V; 1.7 DI 16V; 1.7 DTi 16V	48-55	09.00-	DISC BRAKE	<b>KV 337</b>
<b>KF 292</b>		1.3 CDTi; 1.3 CDTi 16V; 1.7 DI 16V; 1.7 DTi 16V	48-55	09.00-	DRUM BRAKE	<b>KB 338</b>
		1.7 CDTi	74	06.03-	DISC BRAKE	<b>KV 337</b>
<b>KF 134</b>		1.7 CDTi	74	06.03-	DRUM BRAKE	<b>KB 338</b>
<b>KF 134</b>		1.7 CDTi	74	06.03-	DISC BRAKE	<b>KV 337</b>
<b>GT</b>						
<b>KA 040</b>		1.1; 1.9	44-66	09.68-08.73		
<b>KADETT B</b>						
<b>KA 040</b>		1.1; 1.1 S; 1.1 SR; 1.2; 1.2 S; 1.7; 1.9	33-66	09.65-08.73		
<b>KADETT C</b>						
<b>KA 040</b>	--> 12.76 / CH. --> 52696299 / CH. 55151638 -->	1.0; 1.2; 1.2 S	29-44	08.73-07.79		
<b>KA 040</b>		1.0; 1.2; 1.2 S	29-44	08.73-07.79		<b>KA 038</b>
<b>KA 007</b>	01.77--> / CH. 52696300 --> / CH. 55151639 -->	1.0; 1.2; 1.2 S	29-44	08.73-07.79		
<b>KA 007</b>		1.0; 1.2; 1.2 S	29-44	08.73-07.79		<b>KA 038</b>
<b>KA 007</b>		1.6 S; 1.9 GT/E; 2.0 E Rallye; 2.0 GT/E	55-85	09.75-07.79		
<b>KADETT D</b>						
<b>KF 133</b>		1.2; 1.2 S; 1.3 N; 1.3 S	39-55	08.79-08.84		<b>KA 007</b>
<b>KF 133</b>		1.2; 1.2 S; 1.3 N; 1.3 S	39-55	08.79-08.84		
<b>KF 134</b>		1.6 S; 1.8 GT/E	66-85	09.81-08.84		<b>KA 007</b>
<b>KF 134</b>		1.6 D	40	03.82-08.84		<b>KA 007</b>
<b>KADETT E</b>						
<b>KF 133</b>		1.2; 1.3 N	40-44	09.84-08.91		<b>KA 007</b>
<b>KF 137</b>		1.2; 1.3 N	40-44	09.84-08.91		<b>KA 007</b>
<b>KF 134</b>		1.3 N Combo	44	01.86-12.89		<b>KA 039</b>
<b>KF 133</b>		1.3 S; 1.3i	44-55	09.84-02.93		<b>KA 007</b>
<b>KF 137</b>		1.3 S; 1.3i	44-55	09.84-02.93		<b>KA 007</b>
<b>KF 134</b>		1.3 S Combo	55	01.86-12.89		<b>KA 039</b>
<b>KF 133</b>		1.4i	44	01.90-08.91		<b>KA 007</b>
<b>KF 137</b>		1.4i	44	01.90-08.91		<b>KA 007</b>
<b>KF 134</b>		1.4i Combo	44	08.91-07.94		<b>KA 039</b>
<b>KF 134</b>		1.4 S Combo	55	07.89-08.91		<b>KA 039</b>
<b>KF 133</b>		1.4 S	55	01.90-02.93		<b>KA 007</b>
<b>KF 137</b>		1.4 S	55	01.90-02.93		<b>KA 007</b>

	<b>i</b>	<b>ENGINE</b>	<b>POWER (kW)</b>	<b>YEAR</b>	<b>i</b>	
Fersa KIT FRONT						Fersa KIT REAR
<b>OPEL</b>						
<b>KADETT E</b>						
<b>KF 133</b>		1.4 S; 1.6i	55-60	09.86-09.93		<b>KA 007</b>
<b>KF 137</b>		1.4 S; 1.6i	55-60	09.86-09.93		<b>KA 007</b>
<b>KF 134</b>		1.6i Combo	55	08.91-07.94		<b>KA 039</b>
<b>KF 133</b>		1.6; 1.6i	55-60	09.86-02.93		<b>KA 007</b>
<b>KF 137</b>		1.6; 1.6i	55-60	09.86-02.93		<b>KA 007</b>
<b>KF 134</b>		1.6 Combo	60	09.86-12.91		<b>KA 039</b>
<b>KF 133</b>		1.6 S; 1.6i	60	09.86-02.93		<b>KA 007</b>
<b>KF 137</b>		1.6 S; 1.6i	60	09.86-02.93		<b>KA 007</b>
<b>KF 134</b>		1.6 S; 1.8 E; 1.8 GSi; 1.8 GTE; 1.8 S; 1.8i; 2.0 GSi; 2.0 GSi 16V; 2.0i	62-115	08.84-02.93		<b>KA 007</b>
<b>KF 134</b>		1.5 TD; 1.6 D	40-53	08.84-08.91		<b>KA 007</b>
<b>KF 134</b>		1.6 D Combo	40	01.86-12.89		<b>KA 039</b>
<b>KF 134</b>		1.7 D	42	08.88-09.92		<b>KA 007</b>
<b>KF 134</b>		1.7 D Combo	42-44	01.89-07.94		<b>KA 039</b>
<b>MANTA A</b>						
<b>KA 040</b>		1.2; 1.6; 1.6 S; 1.9 GT/E; 1.9 S	44-77	09.70-08.75		
<b>MANTA B</b>						
<b>KA 007</b>		1.2 N; 1.2 S; 1.3 N; 1.3 S; 1.6 N; 1.6 S; 1.8 S; 1.9 E; 1.9 N; 1.9 S; 2.0; 2.0 E; 2.0 S	40-81	09.75-08.88		
<b>KA 038</b>		1.2 N; 1.2 S; 1.3 N; 1.3 S; 1.6 N; 1.6 S; 1.8 S; 1.9 E; 1.9 N; 1.9 S; 2.0; 2.0 E; 2.0 S	40-81	09.75-08.88		
<b>MERIVA</b>						
<b>KF 292</b>		1.4 16V Twinport; 1.6; 1.6 16V	64-77	05.03-	ABS	<b>KV 202</b>
<b>KF 292</b>		1.4 16V Twinport; 1.6; 1.6 16V	64-77	05.03-	<del>ABS</del>	<b>KV 235</b>
<b>KF 134</b>		1.6 Turbo	132	09.05-	ABS	<b>KV 252</b>
<b>KF 292</b>		1.8 16V	92	05.03-	ABS	<b>KV 202</b>
<b>KF 292</b>		1.8 16V	92	05.03-	<del>ABS</del>	<b>KV 235</b>
<b>KF 292</b>		1.3 CDTi	51	04.05-	ABS	<b>KV 202</b>
<b>KF 292</b>		1.3 CDTi	51	04.05-	<del>ABS</del>	<b>KV 235</b>
<b>KF 134</b>		1.3 CDTi	55	09.03-	ABS	<b>KV 252</b>
<b>KF 292</b>		1.7 DTi 16V	55	09.03-		<b>KV 202</b>
<b>KF 292</b>		1.7 DTi 16V	55	09.03-	<del>ABS</del>	<b>KV 235</b>
<b>KF 134</b>		1.7 CDTi	74-92	09.03-	ABS	<b>KV 252</b>
<b>MONTEREY A</b>						
<b>KF 342</b>		3.2	130	06.92-07.98		
<b>KF 342</b>		3.1 TD	84	09.91-07.98		
<b>MONZA A</b>						
<b>KA 039</b>	CH. 91362918 -->	2.0 E; 2.2 E; 2.5 E; 2.8; 3.0; 3.0 GSE	85-132	02.78-08.86		
<b>MOVANO</b>						
<b>KB 293</b>		1.9 DTi; 2.2 DTi; 2.5 CDTi; 2.5 D; 2.5 DTi	59-107	07.98-		<b>KB 344</b>
<b>KB 293</b>		2.5 D	59	01.99-09.00		<b>KB 344</b>
<b>KB 278</b>		2.5 D	59	01.99-09.00		<b>KB 344</b>
<b>KB 293</b>		2.5 D; 2.8 dTi; 3.0 DTi	59-100	07.98-		<b>KB 344</b>
<b>OLYMPIA A</b>						
<b>KA 040</b>		1.0	44	08.67-08.71		
<b>OMEGA A</b>						
<b>KV 135</b>		1.8 N Estate Car	60	09.86-08.87		<b>KF 136</b>
<b>KV 135</b>		1.8 Estate Car	65	09.87-03.94		<b>KF 136</b>
<b>KV 135</b>		1.8 S Estate Car	66	09.86-03.94		<b>KF 136</b>
<b>KV 135</b>		1.8 Estate Car	85	09.86-03.94		<b>KF 136</b>
<b>KV 135</b>		2.0i Estate Car	73	09.90-03.94		<b>KF 136</b>

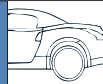

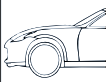
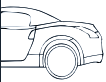
	<b>i</b>	<b>ENGINE</b>	<b>POWER (kW)</b>	<b>YEAR</b>	<b>i</b>	
Fersa KIT FRONT						Fersa KIT REAR
<b>OPEL</b>						
<b>OMEGA A</b>						
<b>KV 135</b>		2.0 Estate Car	74	09.90-03.94		<b>KF 136</b>
<b>KV 135</b>		2.0i Estate Car	85	09.86-03.94		<b>KF 136</b>
<b>KV 135</b>		2.0 Limousine	90	09.86-03.94		
<b>KV 135</b>		2.0 Estate Car; 2.4i Limousine; 2.4i Estate Car; 2.6i Limousine; 2.6i Estate Car; 3.0 Estate Car; 3.0 (3000) Limousine; 3.0 24V Estate Car; 3.0 24V (3000) Limousine;	90-169	09.86-03.94		<b>KF 136</b>
<b>KV 135</b>		3.6 24V Lotus Limousine	277	08.90-09.92		
<b>KV 135</b>		2.3 D Limousine	54	10.86-03.94		
<b>KV 135</b>		2.3 D Estate Car; 2.3 TD Limousine; 2.3 TD Estate Car; 2.3 TD INTERCOOLER Limousine; 2.3 TD INTERCOOLER Estate Car	54-74	09.86-03.94		<b>KF 136</b>
<b>OMEGA B</b>						
<b>KV 135</b>		2.0 Limousine; 2.0i Limousine	85	03.94-12.00		<b>KF 138</b>
<b>KV 135</b>		2.0 Limousine; 2.0i Limousine	85	03.94-12.00		<b>KF 136</b>
<b>KV 135</b>		2.0i Estate Car	85	03.94-09.99		<b>KF 136</b>
<b>KV 135</b>		2.0i 16V Limousine	100	03.94-09.99		<b>KF 138</b>
<b>KV 135</b>		2.0i 16V Limousine	100	03.94-09.99		<b>KF 136</b>
<b>KV 135</b>		2.0i 16V Estate Car	100	03.94-09.99		<b>KF 136</b>
<b>KV 135</b>		2.2i Limousine	106	09.99-07.03		<b>KF 138</b>
<b>KV 135</b>		2.2i Limousine	106	09.99-07.03		<b>KF 136</b>
<b>KV 135</b>		2.2i Estate Car	106	09.99-07.03		<b>KF 136</b>
<b>KV 135</b>		2.5i Limousine	125	03.94-09.00		<b>KF 138</b>
<b>KV 135</b>		2.5i Limousine	125	03.94-09.00		<b>KF 136</b>
<b>KV 135</b>		2.5i Estate Car	125	03.94-09.00		<b>KF 136</b>
<b>KV 135</b>		2.6 V6 Limousine	132	09.00-07.03		<b>KF 138</b>
<b>KV 135</b>		2.6 V6 Limousine	132	09.00-07.03		<b>KF 136</b>
<b>KV 135</b>		2.6 V6 Estate Car	132	09.00-07.03		<b>KF 136</b>
<b>KV 135</b>		3.0i MV6 Limousine	155	04.94-02.01		<b>KF 138</b>
<b>KV 135</b>		3.0i MV6 Limousine	155	04.94-02.01		<b>KF 136</b>
<b>KV 135</b>		3.0i MV6 Estate Car	155	04.94-02.01		<b>KF 136</b>
<b>KV 135</b>		3.2 V6 Limousine	160	02.01-07.03		<b>KF 138</b>
<b>KV 135</b>		3.2 V6 Limousine	160	02.01-07.03		<b>KF 136</b>
<b>KV 135</b>		3.2 V6 Estate Car	160	02.01-07.03		<b>KF 136</b>
<b>KV 135</b>		2.0 DTI 16V Limousine	74	09.97-09.00		<b>KF 138</b>
<b>KV 135</b>		2.0 DTI 16V Limousine	74	09.97-09.00		<b>KF 136</b>
<b>KV 135</b>		2.0 DTI 16V Estate Car	74	09.97-09.00		<b>KF 136</b>
<b>KV 135</b>		2.2 DTI 16V Limousine	88	09.00-07.03		<b>KF 138</b>
<b>KV 135</b>		2.2 DTI 16V Limousine	88	09.00-07.03		<b>KF 136</b>
<b>KV 135</b>		2.2 DTI 16V Estate Car	88	09.00-07.03		<b>KF 136</b>
<b>KV 135</b>		2.5 TD Limousine	96	04.94-07.03		<b>KF 138</b>
<b>KV 135</b>		2.5 TD Limousine	96	04.94-07.03		<b>KF 136</b>
<b>KV 135</b>		2.5 TD Estate Car	96	04.94-02.01		<b>KF 136</b>
<b>KV 135</b>		2.5 DTI Limousine	110	09.01-07.03		<b>KF 138</b>
<b>KV 135</b>		2.5 DTI Limousine	110	09.01-07.03		<b>KF 136</b>
<b>KV 135</b>		2.5 DTI Estate Car	110	09.01-07.03		<b>KF 136</b>
<b>REKORD B</b>						
<b>KA 040</b>		1.5 [13]; 1.5 [15]; 1.7 [17]; 1.7 [19]; 1.7 [21]; 1.9	44-66	08.65-02.67		
<b>REKORD C</b>						
<b>KA 040</b>		1.5; 1.7; 1.7 S; 1.9	43-66	08.66-12.71		
<b>KA 040</b>		2.2	70	08.66-09.69		
<b>REKORD D</b>						
<b>KA 038</b>		1.7,1.9,2.0	44	72-78		

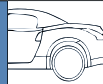
	<b>i</b>	<b>ENGINE</b>	<b>POWER (kW)</b>	<b>YEAR</b>	<b>i</b>	
Fersa KIT FRONT						Fersa KIT REAR
<b>OPEL</b>						
<b>REKORD D</b>						
KA 038		2.1 D	44	72-78		
KA 007		1.7 Limousine	44	03.75-08.77		
KA 007		1.7 Estate Car	44	03.75-08.77		
KA 007		1.7 Limousine	49	01.72-02.75		
KA 007		1.7 Estate Car	49	01.72-02.75		
KA 007		1.7 S Limousine	61	01.72-02.75		
KA 007		1.7 S Estate Car	61	01.72-02.75		
KA 007		1.7 S Coupe; 1.9 Limousine	55-61	01.72-08.77		
KA 007		1.9 Estate Car	55	03.75-08.77		
KA 007		1.9 Limousine; 1.9 Coupe	55-66	03.75-08.77		
KA 007		1.9 Estate Car	66	03.75-08.77		
KA 007		1.9 Coupe; 1.9 S Limousine	66-71	01.72-08.77		
KA 007		1.9 S Estate Car	71	01.72-02.75		
KA 007		1.9 S Coupe; 2.0 Limousine; 2.0 Coupe	71-74	01.72-08.77		
KA 007		2.0 S Estate Car	74	09.75-08.77		
KA 007		2.0 D Limousine	40	08.74-08.77		
KA 007		2.0 D Estate Car	40	08.74-08.77		
KA 007		2.1 D Limousine	44	09.72-08.77		
KA 007		2.1 D Estate Car	44	09.72-08.77		
<b>REKORD E</b>						
KA 007	[M.T]	1.7 Limousine	44	09.77-10.82		
KA 039	[A.T]	1.7 Limousine	44	09.77-10.82		
KA 007	[M.T]	1.7 Estate Car	44	09.77-10.82		
KA 039	[A.T]	1.7 Estate Car	44	09.77-10.82		
KA 007		1.8 Limousine	55	11.82-08.86		
KA 007		1.8 Estate Car	55	11.82-08.86		
KA 007		1.8 S Limousine	66	11.82-08.86		
KA 007		1.8 S Estate Car	66	11.82-08.86		
KA 007		1.8 E Limousine	74	05.85-08.86		
KA 007		1.8 E Estate Car	74	05.85-08.86		
KA 007	[M.T]	1.9 Limousine	55	09.77-10.82		
KA 039	[A.T]	1.9 Limousine	55	09.77-10.82		
KA 007	[M.T]	1.9 Estate Car	55	09.77-10.82		
KA 039	[A.T]	1.9 Estate Car	55	09.77-10.82		
KA 007	[M.T]	2.0 Limousine	66	09.77-10.82		
KA 039	[A.T]	2.0 Limousine	66	09.77-10.82		
KA 007	[M.T]	2.0 Estate Car	66	09.77-10.82		
KA 039	[A.T]	2.0 Estate Car	66	09.77-10.82		
KA 007	[M.T]	2.0 S Limousine	74	08.77-08.86		
KA 039	[A.T]	2.0 S Limousine	74	08.77-08.86		
KA 038	CH. 11028763 -->	2.0,2.1,2.3 D	74	78-86		
KA 007	[M.T]	2.0 E Limousine; 2.0 E Estate Car; 2.0 S Estate Car	74-81	08.77-08.86		
KA 039	[A.T]	2.0 E Limousine; 2.0 E Estate Car; 2.0 S Estate Car	74-81	08.77-08.86		
KA 007		2.2 E Limousine; 2.2 E Estate Car	85	11.84-08.86		
KA 039		2.0 D Limousine; 2.0 D Estate Car; 2.1 D Limousine; 2.1 D Estate Car; 2.2 D Limousine;	43-63	09.77-08.86		
<b>SENATOR A</b>						
KA 039		2.0 E; 2.2 E	85	03.83-08.87		
KA 039	CH. 91362918 -->	2.5	85	05.78-12.80		
KA 039		2.5 E	100-103	01.83-08.87		

	<b>i</b>	ENGINE	POWER (kW)	YEAR	<b>i</b>	
Fersa KIT FRONT						Fersa KIT REAR
<b>OPEL</b>						
<b>SENATOR A</b>						
<b>KA 039</b>	CH. 91362918 -->	2.8; 3.0	103-110	02.78-07.82		
<b>KA 039</b>		3.0	115	09.85-08.87		
<b>KA 039</b>	CH. 91362918 -->	3.0 E	132	02.78-12.86		
<b>KA 039</b>		2.2 TD	63	11.84-08.87		
<b>SENATOR B</b>						
<b>KV 135</b>		2.5i; 2.6i; 3.0; 3.0 24V; 3.0i	103-150	09.87-09.93		<b>KF 136</b>
<b>SIGNUM</b>						
<b>KV 343</b>	--> 12.04	1.8; 2.0 Turbo; 2.2; 3.2 V6	90-155	05.03-		
<b>KV 335</b>	01.05 -->	1.8; 2.0 Turbo; 2.2; 3.2 V6	90-155	05.03-	ABS	<b>KV 336</b>
<b>KV 343</b>	--> 12.04	1.9 CDTI; 2.0 DTI; 2.2 DTI; 3.0 V6 CDTI	74-130	05.03-		
<b>KV 335</b>	01.05 -->	1.9 CDTI; 2.0 DTI; 2.2 DTI; 3.0 V6 CDTI	74-130	05.03-	ABS	<b>KV 336</b>
<b>TIGRA</b>						
<b>KF 137</b>		1.4 16V; 1.6 16V	63-78	07.94-12.00	ABS	<b>KA 007</b>
<b>KF 137</b>		1.4i, 1.6i	63-78	94-		<b>KA 038</b>
<b>KF 137</b>		1.4i, 1.6i	63-78	94-		<b>KA 038</b>
<b>TIGRA TWINTOP</b>						
<b>KF 292</b>		1.4; 1.8	66-92	06.04-	DISC BRAKE	<b>KV 337</b>
<b>KF 292</b>		1.4; 1.8	66-92	06.04-	DRUM BRAKE	<b>KB 338</b>
<b>KF 292</b>		1.3 CDTI	51	06.04-	DISC BRAKE	<b>KV 337</b>
<b>KF 292</b>		1.3 CDTI	51	06.04-	DRUM BRAKE	<b>KB 338</b>
<b>VECTRA A</b>						
<b>KF 133</b>		1.4	55	89-93		<b>KA 038</b>
<b>KF 133</b>		1.6	52	87-93		<b>KA 038</b>
<b>KF 134</b>	ABS	1.6	52	87-93		<b>KA 038</b>
<b>KF 134</b>		1.7 D, TD	52	93-94		<b>KA 038</b>
<b>KF 134</b>	ABS	1.8	52	87-95		<b>KA 038</b>
<b>KF 134</b>	ABS	2.0 8V	52	87-94		<b>KA 038</b>
<b>KF 133</b>		1.4 Limousine; 1.4 Hatchback	55	04.88-06.92	ABS	<b>KA 007</b>
<b>KF 133</b>	CH. --> P*999999 / [M.T]	1.6i Limousine	52	09.93-11.95	ABS	<b>KV 202</b>
<b>KF 137</b>	CH. R*000001--> / CH. R7500001 -->	1.6i Limousine	52	09.93-11.95	ABS	<b>KV 202</b>
<b>KF 133</b>	CH. --> P*999999 / [M.T]	1.6i Limousine	52	09.93-11.95	ABS	<b>KV 235</b>
<b>KF 137</b>	CH. R*000001--> / CH. R7500001 -->	1.6i Limousine	52	09.93-11.95	ABS	<b>KV 235</b>
<b>KF 133</b>	CH. --> P*999999 / [M.T]	1.6i Hatchback	52	09.93-11.95	ABS	<b>KV 202</b>
<b>KF 137</b>	CH. R*000001--> / CH. R7500001 -->	1.6i Hatchback	52	09.93-11.95	ABS	<b>KV 202</b>
<b>KF 133</b>	CH. --> P*999999 / [M.T]	1.6i Hatchback	52	09.93-11.95	ABS	<b>KV 235</b>
<b>KF 137</b>	CH. R*000001--> / CH. R7500001 -->	1.6i Hatchback	52	09.93-11.95	ABS	<b>KV 235</b>
<b>KF 133</b>	CH. --> P*999999	1.6i Limousine; 1.6i Hatchback	55	09.88-11.95		
<b>KF 134</b>	CH. --> P*999999	1.6i Limousine; 1.6i Hatchback	55	09.88-11.95		
<b>KF 137</b>	CH. R*000001--> / CH. R7500001 -->	1.6i Limousine; 1.6i Hatchback	55	09.88-11.95		
		1.6i Limousine; 1.6i Hatchback	55	09.88-11.95	--> 12.93	<b>KA 007</b>
		1.6i Limousine; 1.6i Hatchback	55	09.88-11.95	ABS / 01.94 -->	<b>KV 202</b>
		1.6i Limousine; 1.6i Hatchback	55	09.88-11.95	ABS / 01.94 -->	<b>KV 235</b>
<b>KF 133</b>	CH. --> P*999999 / [M.T]	1.6i Limousine	55	09.88-10.90	ABS	<b>KA 007</b>
<b>KF 137</b>	CH. R*000001--> / CH. R7500001 -->	1.6i Limousine	55	09.88-10.90	ABS	<b>KA 007</b>
<b>KF 134</b>	CH. --> P*999999	1.6i Limousine	55	09.93-11.95	ABS	<b>KV 202</b>
<b>KF 134</b>	CH. --> P*999999	1.6i Limousine	55	09.93-11.95	ABS	<b>KV 235</b>

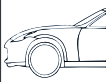
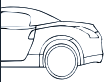

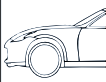
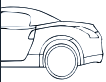

	<b>i</b>	<b>ENGINE</b>	<b>POWER (kW)</b>	<b>YEAR</b>	<b>i</b>	
Fersa KIT FRONT						Fersa KIT REAR
<b>OPEL</b>						
<b>VECTRA A</b>						
<b>KF 134</b>	CH. --> P*999999	1.6i Hatchback	55	09.93-11.95	ABS	<b>KV 202</b>
<b>KF 137</b>	CH. R*000001--> / CH. R7500001 -->	1.6i Hatchback	55	09.93-11.95	ABS	<b>KV 202</b>
<b>KF 134</b>	CH. --> P*999999	1.6i Hatchback	55	09.93-11.95	<del>ABS</del>	<b>KV 235</b>
<b>KF 137</b>	CH. R*000001--> / CH. R7500001 -->	1.6i Hatchback	55	09.93-11.95	<del>ABS</del>	<b>KV 235</b>
<b>KF 133</b>	CH. --> P*999999 / [M.T]	1.6 Limousine; 1.6 S Hatchback	60	09.88-05.93	<del>ABS</del>	<b>KA 007</b>
<b>KF 134</b>	CH. --> P*999999 / [A.T]	1.6 Limousine; 1.6 S Hatchback	60	09.88-05.93	<del>ABS</del>	<b>KA 007</b>
<b>KF 134</b>		1.8 S 4x4 Limousine	65	01.89-07.89		<b>KF 136</b>
<b>KF 134</b>		1.8 S Limousine; 1.8 S Hatchback; 1.8i Hatchback	65-66	09.88-10.90	<del>ABS</del>	<b>KA 007</b>
<b>KF 134</b>		1.8i Limousine; 1.8i Hatchback	66	03.90-11.95	--> 12.93	<b>KA 007</b>
<b>KF 134</b>		1.8i Limousine; 1.8i Hatchback	66	03.90-11.95	ABS / 01.94 -->	<b>KV 202</b>
<b>KF 134</b>		1.8i Limousine; 1.8i Hatchback	66	03.90-11.95	<del>ABS</del> / 01.94 -->	<b>KV 235</b>
<b>KF 134</b>		2.0 Limousine; 2.0 Hatchback; 2.0i Limousine; 2.0i Hatchback	74-85	04.88-10.90	ABS	<b>KA 007</b>
<b>KF 134</b>		2.0i Limousine; 2.0i Hatchback	85	09.88-11.95	--> 12.93	<b>KA 007</b>
<b>KF 134</b>		2.0i Limousine; 2.0i Hatchback	85	09.88-11.95	ABS / 01.94 -->	<b>KV 202</b>
<b>KF 134</b>		2.0i Limousine; 2.0i Hatchback	85	09.88-11.95	<del>ABS</del> / 01.94 -->	<b>KV 235</b>
<b>KF 134</b>		2.0i 16V 4x4 Limousine; 2.0i 4x4 Limousine; 2000 16V 4x4 Limousine	85-110	01.89-11.95		<b>KF 136</b>
<b>KF 134</b>		2.0i Limousine	95	09.88-09.92	ABS	<b>KA 007</b>
<b>KF 134</b>		2.0i GT Hatchback	95	09.88-11.95	--> 12.93	<b>KA 007</b>
<b>KF 134</b>		2.0i GT Hatchback	95	09.88-11.95	ABS / 01.94 -->	<b>KV 202</b>
<b>KF 134</b>		2.0i GT Hatchback	95	09.88-11.95	<del>ABS</del> / 01.94 -->	<b>KV 235</b>
<b>KF 134</b>		2.0i 16V Limousine	100	06.94-11.95	ABS	<b>KA 007</b>
<b>KF 134</b>		2.0i 16V Hatchback	100	06.94-11.95	ABS	<b>KA 007</b>
<b>KF 134</b>		2.0i 16V Hatchback; 2000/GT 16V Limousine	110	01.89-06.94		<b>KF 136</b>
<b>KF 134</b>		2.0i 16V Hatchback	110	02.90-11.95	CH. --> N*999999	<b>KF 136</b>
<b>KF 134</b>	CH. --> N*999999	2000/GT 16V Limousine	110	02.90-11.95	--> 12.92	<b>KF 136</b>
<b>KF 134</b>	--> 12.92	2000/GT 16V 4x4 Limousine	110	02.90-11.95		
		2000/GT 16V 4x4 Limousine	110	02.90-11.95	CH. --> N*999999	<b>KF 136</b>
<b>KF 134</b>	CH. --> N1999999	2.0i TURBO 4x4 Limousine	150	06.94-11.95		<b>KF 136</b>
<b>KF 138</b>	CH. P1000001 -->	2.0i TURBO 4x4 Limousine	150	06.94-11.95		<b>KF 136</b>
<b>KF 138</b>		2.5 V6 Limousine; 2.5 V6 Hatchback	125	02.93-11.95		<b>KV 252</b>
<b>KF 134</b>		1.7 TD Limousine; 1.7 TD Hatchback	60	03.90-11.95	--> 12.93	<b>KA 007</b>
<b>KF 134</b>		1.7 TD Limousine; 1.7 TD Hatchback	60	03.90-11.95	ABS / 01.94 -->	<b>KV 202</b>
<b>KF 134</b>		1.7 TD Limousine; 1.7 TD Hatchback	60	03.90-11.95	<del>ABS</del> / 01.94 -->	<b>KV 235</b>
<b>KF 134</b>		1.7 D Limousine; 1.7 D Hatchback	42	09.88-09.92		<b>KA 007</b>
<b>KF 134</b>		1.7 D Limousine; 1.7 D Hatchback	44	07.92-11.95	--> 12.93	<b>KA 007</b>
<b>KF 134</b>		1.7 D Limousine; 1.7 D Hatchback	44	07.92-11.95	ABS / 01.94 -->	<b>KV 202</b>
<b>KF 134</b>		1.7 D Limousine; 1.7 D Hatchback	44	07.92-11.95	<del>ABS</del> / 01.94 -->	<b>KV 235</b>
<b>VECTRA B</b>						
<b>KF 138</b>		1.6i; 1.6i 16V; 1.8i 16V	55-85	10.95-07.03	--> 12.98 / CH. --> W1999999	<b>KV 202</b>
<b>KF 138</b>		1.6i; 1.6i 16V; 1.8i 16V	55-85	10.95-07.03	01.99 --> / CH. X1000001 -->	<b>KV 252</b>
<b>KF 138</b>		1.8i 16V	92	09.00-07.03		<b>KV 252</b>
<b>KF 138</b>		2.0i	82	10.95-04.02	--> 12.98 / CH. --> W1999999	<b>KV 202</b>
<b>KF 138</b>		2.0i	82	10.95-04.02	01.99 --> / CH. X1000001 -->	<b>KV 252</b>
<b>KF 138</b>		2.0i 16V; 2.2i 16V; 2.5i 500; 2.5i V6; 2.6i V6	100-143	10.95-07.03		<b>KV 252</b>
<b>KF 138</b>		1.7 TD	60	10.95-12.98		<b>KV 202</b>
<b>KF 138</b>		2.0 DI 16V; 2.0 DTI 16V	60-74	11.96-07.03	--> 12.98 / CH. --> W1999999	<b>KV 202</b>
<b>KF 138</b>		2.0 DI 16V; 2.0 DTI 16V	60-74	11.96-07.03	01.99 --> / CH. X1000001 -->	<b>KV 252</b>
<b>KF 138</b>		2.2 DTI 16V	92	09.00-07.03		<b>KV 252</b>

	<b>i</b>	<b>ENGINE</b>	<b>POWER (kW)</b>	<b>YEAR</b>	<b>i</b>	
Fersa KIT FRONT						Fersa KIT REAR
<b>OPEL</b>						
<b>VECTRA C / GTS</b>						
<b>KV 343</b>	CH. --> 41999999/ CH. --> 48999999	1.6; 1.6 16V; 1.8; 1.8 16V; 2.0 16V Turbo; 2.0 Turbo; 2.2 16V; 2.2 direct; 2.8 V6 Turbo; 3.2 V6	74-206	04.02-		<b>KV 336</b>
<b>KV 335</b>	CH. 51000001 --> / CH. 58000001 -->	1.6; 1.6 16V; 1.8; 1.8 16V; 2.0 16V Turbo; 2.0 Turbo; 2.2 16V; 2.2 direct; 2.8 V6 Turbo; 3.2 V6	74-206	04.02-		<b>KV 336</b>
<b>KV 343</b>	CH. --> 41999999/ CH. --> 48999999	1.9 CDTI; 2.0 DTI; 2.0 DTI 16V; 2.2 DTI; 2.2 DTI 16V; 3.0 CDTI; 3.0 V6 CDTI	74-135	04.02-		<b>KV 336</b>
<b>KV 335</b>	CH. 51000001 --> / CH. 58000001 -->	1.9 CDTI; 2.0 DTI; 2.0 DTI 16V; 2.2 DTI; 2.2 DTI 16V; 3.0 CDTI; 3.0 V6 CDTI	74-135	04.02-		<b>KV 336</b>
<b>VIVARO</b>						
<b>KF 334</b>		2.0 ECOTEC	86	08.06-		<b>KB 339</b>
<b>KF 340</b>	ABS / CH. --> 3V613233	2.0 16V	88	08.01-		<b>KB 339</b>
<b>KF 315</b>	ABS / CH. --> 3V613233	2.0 16V	88	08.01-		<b>KB 339</b>
<b>KF 334</b>	CH. 3V613234 -->	2.0 16V	88	08.01-		<b>KB 339</b>
		2.0 16V	88	08.01-		<b>KB 339</b>
<b>KF 340</b>	ABS / CH. --> 3V613233	1.9 DI; 1.9 DTI	60-74	08.01-		<b>KB 339</b>
<b>KF 315</b>	ABS / CH. --> 3V613233	1.9 DI; 1.9 DTI	60-74	08.01-		<b>KB 339</b>
<b>KF 334</b>	CH. 3V613234 -->	1.9 DI; 1.9 DTI	60-74	08.01-		<b>KB 339</b>
		1.9 DI; 1.9 DTI	60-74	08.01-		<b>KB 339</b>
<b>KF 334</b>		2.0 CDTI	66-84	08.06-		<b>KB 339</b>
		2.0 CDTI	66-84	08.06-		<b>KB 339</b>
<b>KF 340</b>	ABS / CH. --> 3V613233	2.5 DTI	99	05.03-		<b>KB 339</b>
<b>KF 315</b>	ABS / CH. --> 3V613233	2.5 DTI	99	05.03-		<b>KB 339</b>
<b>KF 334</b>	CH. 3V613234 -->	2.5 DTI	99	05.03-		<b>KB 339</b>
		2.5 DTI	99	05.03-		<b>KB 339</b>
<b>KF 334</b>		2.5 CDTI; 2.5 DTI	84-107	05.03-		<b>KB 339</b>
<b>VIVARO PRITSCH/FAHRGESTELL (E7)</b>						
<b>KF 334</b>		2.0 ECOTEC	86	08.06-		<b>KB 339</b>
<b>KF 334</b>		2.0 CDTI; 2.5 CDTI	66-107	01.06-		<b>KB 339</b>
<b>ZAFIRA</b>						
<b>KV 332</b>	CH. --> 62034065	1.6	69	01.06-		<b>KV 331</b>
<b>KV 332</b>	CH. --> 6G019309	1.6	69	01.06-		<b>KV 331</b>
<b>KV 332</b>		1.6; 1.8	77-103	07.05-		<b>KV 331</b>
<b>KV 332</b>	CH. --> 62034065	2.0	147	07.05-		<b>KV 331</b>
<b>KV 332</b>	CH. --> 6G019309	2.0	147	07.05-		<b>KV 331</b>
		2.0	177	01.06-		<b>KV 331</b>
<b>KV 332</b>	CH. --> 62034065	2.2	110	07.05-		<b>KV 331</b>
<b>KV 332</b>	CH. --> 6G019309	2.2	110	07.05-		<b>KV 331</b>
		2.2	110	07.05-		<b>KV 331</b>
		1.7 CDTI	81-92	01.08-		<b>KV 331</b>
<b>KV 332</b>	CH. --> 62034065	1.9 CDTI	74-88	07.05-		<b>KV 331</b>
<b>KV 332</b>	CH. --> 6G019309	1.9 CDTI	74-88	07.05-		<b>KV 331</b>
		1.9 CDTI	110	07.05-		<b>KV 331</b>
<b>ZAFIRA (F75_)</b>						
<b>KV 199</b>	ABS	1.6; 1.6 16V; 1.6 CGN; 1.8; 1.8 16V; 2.0 OPC; 2.2i 16V	70-147	04.99-06.05	ABS	<b>KV 252</b>
<b>KV 247</b>	ABS	1.6; 1.6 16V; 1.6 CGN; 1.8; 1.8 16V; 2.0 OPC; 2.2i 16V	70-147	04.99-06.05	ABS	<b>KV 279</b>
<b>KV 199</b>	ABS	2.0 DI 16V; 2.0 DTI 16V; 2.2 DTI 16V	60-92	10.99-06.05	ABS	<b>KV 252</b>
<b>KV 247</b>	ABS	2.0 DI 16V; 2.0 DTI 16V; 2.2 DTI 16V	60-92	10.99-06.05	ABS	<b>KV 279</b>

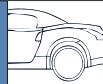
	<b>i</b>	<b>ENGINE</b>	<b>POWER (kW)</b>	<b>YEAR</b>	<b>i</b>	
Fersa KIT FRONT						Fersa KIT REAR
<b>PEUGEOT</b>						
<b>104</b>						
		0.9 Hatchback	32	09.83-06.88	CH. 5496582-> / CH. 7029645 ->	<b>KA 073</b>
		0.9 Hatchback; 0.9 Coupe	33	09.73-10.83	--> 07.80 / CH. 5496582 --> / CH. 7029645 -->	<b>KA 073</b>
		1.1 Hatchback; 1.1 Coupe	37	08.79-06.88	CH. 5496582-> / CH. 7029645 -->	<b>KA 073</b>
		1.1 Hatchback; 1.1 Coupe	42	07.76-06.83	--> 07.80 / CH. 5496582 --> / CH. 7029645 -->	<b>KA 073</b>
		1.1 Hatchback; 1.1 Coupe	48-49	09.73-06.80	CH. 5656287 --> / CH. 7159482 -->	<b>KA 073</b>
		1.2 Hatchback; 1.4 Hatchback; 1.4 Coupe	42-53	08.79-06.84	--> 07.80 / CH. 5496582 --> / CH. 7029645 -->	<b>KA 073</b>
<b>106 I (1A/C)</b>						
<b>KF 142</b>		1.0; 1.1	33-44	09.91-04.96		
<b>KF 111</b>		1.0; 1.1	33-44	09.91-04.96		<b>KF 112</b>
<b>KF 111</b>		1.0; 1.1	33-44	09.91-04.96		<b>KB 008</b>
<b>KF 142</b>		1.3; 1.4; 1.6	55-76	09.91-04.96		<b>KB 008</b>
<b>KF 142</b>		1.4 D; 1.5 D	37-43	09.92-04.96		<b>KB 008</b>
<b>106 II (1)</b>						
<b>KF 111</b>	--> 12.00	1.0i; 1.1i	33-44	05.96-		
<b>KF 142</b>	--> 01.99	1.0i; 1.1i	33-44	05.96-	--> 01.99	<b>KF 112</b>
<b>KF 142</b>	--> 01.99	1.0i; 1.1i	33-44	05.96-	--> 01.99	<b>KB 008</b>
<b>KF 145</b>	02.99 -->	1.0i; 1.1i	33-44	05.96-	02.99 -->	<b>KF 112</b>
<b>KF 145</b>	02.99 -->	1.0i; 1.1i	33-44	05.96-	02.99 -->	<b>KB 008</b>
<b>KF 142</b>	--> 01.99	1.4i; 1.6i	55-65	05.96-	--> 01.99	<b>KB 008</b>
<b>KF 145</b>	02.99 -->	1.4i; 1.6i	55-65	05.96-	02.99 -->	<b>KB 008</b>
<b>KF 142</b>	--> 01.99	1.6 S16; 1.6i	74-87	05.96-	<del>ABS</del>	<b>KV 275</b>
<b>KF 145</b>	02.99 -->	1.6 S16; 1.6i	74-87	05.96-	<del>ABS</del>	<b>KV 275</b>
<b>KF 142</b>	--> 01.99	1.5 D	40	05.96-	--> 01.99	<b>KB 008</b>
<b>KF 145</b>	02.99 -->	1.5 D	40	05.96-	02.99 -->	<b>KB 008</b>
<b>KF 145</b>		1.5 D	42	10.00-		<b>KB 008</b>
<b>KF 145</b>		1.0; 1.1	33-44	02.99-		<b>KB 078</b>
<b>KF 145</b>		1.4	33-44	02.99-		<b>KB 078</b>
<b>KF 142</b>		1.6	33-44	02.99-		<b>KB 078</b>
<b>KF 145</b>		1.5 D	33-44	02.99-		<b>KB 078</b>
<b>KF 142</b>		SA13 Electric	33-44	02.99-		<b>KB 078</b>
<b>204</b>						
<b>KF 139</b>		1.1 Limousine	43	09.75-07.77		<b>KA 088</b>
		1.1 Limousine; 1.1 Coupe; 1.1 Convertible	39-40	10.65-05.70		<b>KA 088</b>
		1.1 Convertible	40	05.69-10.70		<b>KA 088</b>
<b>KF 139</b>	09.72 -->	1.1 GRAND LUXE Estate Car	40	05.69-10.77		<b>KA 088</b>
<b>KF 139</b>	09.72 -->	1.1 Limousine	40	07.69-07.77		<b>KA 088</b>
<b>KF 139</b>		1.2 D Estate Car; 1.4 D Estate Car	29-33	05.68-10.77		<b>KA 088</b>
<b>205</b>						
<b>KF 143</b>	ABS	1.7 Diesel Bus	44	03.94-	ABS	<b>KV 219</b>
<b>KF 142</b>	<del>ABS</del>	1.7 Diesel Bus	44	03.94-	<del>ABS</del>	<b>KB 008</b>
<b>205 I (741A/C)</b>						
<b>KF 142</b>		0.9; 1.1; 1.3; 1.4	33-59	02.83-10.87		<b>KB 008</b>
<b>KF 143</b>		1.6; 1.6 GTi	53-76	12.84-10.87	ABS	<b>KV 219</b>
<b>KF 142</b>		1.6; 1.6 GTi	53-76	12.84-10.87	<del>ABS</del>	<b>KB 008</b>
<b>KF 143</b>		1.9 GTi	75-94	10.86-10.87	DISC BRAKE	<b>KV 219</b>
<b>KF 143</b>		1.8 D	44	08.83-10.87	ABS	<b>KV 219</b>

	<b>i</b>	<b>ENGINE</b>	<b>POWER (kW)</b>	<b>YEAR</b>	<b>i</b>	
Fersa KIT FRONT						Fersa KIT REAR
<b>PEUGEOT</b>						
<b>205 I (741A/C)</b>						
KF 142		1.8 D	44	08.83-10.87	ABS	KB 008
KF 142		1.1 CJ Convertible; 1.4 CJ Convertible; 1.4 CT Convertible	44-58	04.86-12.94		KB 008
KF 143		1.6 CJ Convertible; 1.6 CTi Convertible; 1.9 CTi Convertible	65-76	04.86-12.94	ABS	KV 219
KF 142		1.6 CJ Convertible; 1.6 CTi Convertible; 1.9 CTi Convertible	65-76	04.86-12.94	ABS	KB 008
<b>205 II (20A/C)</b>						
KF 142		1.0; 1.1; 1.2; 1.4	33-74	01.87-09.98		KB 008
KF 143		1.6; 1.6 GTI	53-85	10.87-09.98	ABS	KV 219
KF 142		1.6; 1.6 GTI	53-85	10.87-09.98	ABS	KB 008
KF 143		1.9 GTI	75-94	10.87-09.98		
		1.9 GTI	75-94	10.87-09.98	DISC BRAKE	KV 219
KF 143		1.8 D; 1.8 TD; 1.9 D	44-57	07.87-09.98	ABS	KV 219
KF 142		1.8 D; 1.8 TD; 1.9 D	44-57	07.87-09.98	ABS	KB 008
<b>206</b>						
KF 145		1.1, 1.4, 1.6 (TU)	44	09.98-		KB 078
KF 145		1.1, 1.4, 1.6 (TU)	44	98-		KB 078
KF 145		1.9 D	44	09.98-		KB 078
KF 145		1.9 D	44	09.98-		KB 078
KF 143		2.0 TD (DW10)	44	98-		KB 078
KF 145		1.1i Hatchback	44	09.98-	CH. --> 7958	KB 008
KF 145		1.1i Hatchback	44	09.98-	CH. 7959 -->	KB 008
KF 145		1.1 Estate Car	44	07.02-		KB 008
KF 145		1.4i Hatchback	55	09.98-	CH. --> 7958	KB 008
KF 145		1.4i Hatchback	55	09.98-	CH. 7959 -->	KB 008
KF 145		1.4 Estate Car	55	07.02-		KB 008
KF 145		1.4 Estate Car	65	10.03-		KB 008
KF 145		1.6i Hatchback	65	09.98-12.00	CH. --> 7958	KB 008
KF 145		1.6i Hatchback	65	09.98-12.00	CH. 7959 -->	KB 008
KF 143		1.6 16V Hatchback	80	12.00-		
KF 143		1.6 16V Estate Car	80	07.02-		
KF 143		1.6 16V Convertible; S16 Hatchback	80-99	04.99-		
KF 143		2.0 S16 Convertible	100	09.00-		
KF 143		2.0 S16 Hatchback	100	10.00-		
KF 143		2.0 16V Estate Car	100	07.02-		
KF 145		1.4 HDi Hatchback; 1.4 HDi Estate Car	50	09.01-		KB 008
KF 143		1.6 HDi FAP 110 Estate Car	80	05.04-		
KF 145		1.9 D Hatchback	51	09.98-11.01	CH. --> 7958	KB 008
KF 145		1.9 D Hatchback	51	09.98-11.01	CH. 7959 -->	KB 008
KF 143		2.0 HDi 90 Hatchback	66	12.99-		KB 008
KF 143		2.0 HDi Estate Car	66	07.02-		KB 008
<b>206 (2E/K)</b>						
KF 145		1.1 Estate Car; 1.4 Estate Car	44-55	07.02-		KB 008
KF 145		1.4 Estate Car	65	10.03-		KB 008
KF 143		1.6 16V Estate Car; 2.0 16V Estate Car	80-100	07.02-		
KF 145		1.4 HDi Estate Car	50	07.02-		KB 008
KF 143		1.6 HDi FAP 110 Estate Car	80	05.04-		
KF 143		2.0 HDi Estate Car	66	07.02-		KB 008
		2.0 HDi Estate Car	66	07.02-		KB 008
<b>207</b>						
KF 354		1.4; 1.4 16V; 1.6 16V; 1.6 16V RC; 1.6 16V Turbo; 1.6 16V VTi	53-128	02.06-		

	<b>i</b>	<b>ENGINE</b>	<b>POWER (kW)</b>	<b>YEAR</b>	<b>i</b>	
Fersa KIT FRONT						Fersa KIT REAR
<b>PEUGEOT</b>						
<b>207</b>						
<b>KF 354</b>		1.4 HDi; 1.6 HDi	50-80	02.06-		
<b>207 CC</b>						
<b>KF 354</b>		1.6 16V; 1.6 16V Turbo	88-110	02.07-		
<b>KF 354</b>		1.6 HDi	80	02.07-		
<b>207 SW</b>						
<b>KF 354</b>		1.4; 1.4 16V; 1.6 16V	54-88	06.07-		
<b>KF 354</b>		1.6 HDi	66-80	06.07-		
<b>304</b>						
<b>KF 139</b>		1.1 (D11) Estate Car	43	10.76-10.80		<b>KA 088</b>
<b>KF 139</b>	09.72 -->	1.3 (B01) Convertible; 1.3 (C01) Coupe; 1.3 (D01) Estate Car; 1.3 GT (A01) Limousine	48	10.69-10.80		<b>KA 088</b>
<b>KF 139</b>		1.3 (B02) Convertible; 1.3 (C02) Coupe; 1.3 (M02) Limousine; 1.3 GL (M01) Limousine	48-55	03.72-10.79		<b>KA 088</b>
<b>KF 139</b>		1.4 (M20) Limousine; 1.4 D Estate Car	33	10.76-10.79		<b>KA 088</b>
<b>305 I</b>						
<b>KF 139</b>		1.3 Limousine	44	11.77-09.82		<b>KA 088</b>
<b>KF 139</b>		1.3 Estate Car	44	08.80-09.82		<b>KA 089</b>
<b>KF 139</b>		1.3 Limousine; 1.5 Limousine	48-54	11.77-09.82		<b>KA 088</b>
<b>KF 139</b>		1.5 Estate Car	54	08.80-09.82		<b>KA 089</b>
<b>KF 139</b>		1.5 Limousine	65	05.80-09.82		<b>KA 088</b>
<b>KF 139</b>		1.5 D Limousine	36	11.77-09.82		<b>KA 088</b>
<b>KF 139</b>		1.5 D Estate Car	36	08.80-09.82		<b>KA 089</b>
<b>305 II</b>						
<b>KF 139</b>	--> 12.82	1.3 Limousine	44	10.82-08.85	--> 12.82	<b>KA 088</b>
<b>KF 143</b>	09.84 --> / CH. 9404639 -->	1.3 Limousine	44	10.82-08.85		
		1.3 Limousine	44	10.82-08.85	--> 01.83	<b>KV 144</b>
<b>KF 139</b>	--> 12.82	1.3 Estate Car	44	10.82-08.86	--> 12.82	<b>KA 089</b>
<b>KF 143</b>	09.84 --> / CH. 9404639 -->	1.3 Estate Car	44	10.82-08.86		
<b>KF 143</b>		1.5 Limousine	50	09.85-07.90		
		1.5 Limousine	50	09.85-07.90	<b>ABS</b>	<b>KV 144</b>
<b>KF 143</b>		1.5 Estate Car	50	09.85-10.86		
<b>KF 139</b>	--> 12.82	1.5 Limousine	54	10.82-08.85	--> 12.82	<b>KV 144</b>
<b>KF 143</b>	09.84 --> / CH. 9404639 -->	1.5 Limousine	54	10.82-08.85		
		1.5 Limousine	54	10.82-08.85	--> 01.83	<b>KA 088</b>
<b>KF 139</b>	--> 12.82	1.5 Estate Car	54	10.82-08.86	--> 12.82	<b>KA 089</b>
<b>KF 143</b>	09.84 --> / CH. 9404639 -->	1.5 Estate Car	54	10.82-08.86		
<b>KF 143</b>		1.6 Limousine	54	11.86-12.88	<b>ABS</b>	<b>KV 144</b>
<b>KF 143</b>		1.6 Estate Car	54	11.86-12.88		
<b>KF 139</b>	--> 12.82	1.6 Limousine	55	10.82-07.88	--> 12.82	<b>KA 088</b>
<b>KF 143</b>	09.84 --> / CH. 9404639 -->	1.6 Limousine	55	10.82-07.88		
		1.6 Limousine	55	10.82-07.88	--> 01.83	<b>KV 144</b>
<b>KF 143</b>		1.6 Estate Car	55	02.86-12.88		
<b>KF 143</b>		1.6 Limousine	66	07.84-08.87	<b>ABS</b>	<b>KV 144</b>
		1.6 Limousine	66	07.84-08.87	<b>ABS</b>	<b>KV 144</b>
<b>KF 143</b>		1.6 Estate Car	66	07.84-12.87		
<b>KF 139</b>	--> 12.82	1.6 Limousine	69	10.82-06.88	--> 12.82	<b>KA 088</b>
<b>KF 143</b>	09.84 --> / CH. 9404639 -->	1.6 Limousine	69	10.82-06.88		
		1.6 Limousine	69	10.82-06.88	--> 01.83	<b>KV 144</b>
		1.6 Limousine	71	10.82-06.84		<b>KV 144</b>
<b>KF 143</b>		1.6 Estate Car	71	09.83-06.84		

	<b>i</b>	ENGINE	POWER (kW)	YEAR	<b>i</b>	
Fersa KIT FRONT						Fersa KIT REAR
<b>PEUGEOT</b>						
<b>305 II</b>						
<b>KF 143</b>		1.9 Limousine	72	11.86-12.88	<b>ABS</b>	<b>KV 144</b>
		1.9 Limousine	72	11.86-12.88	<b>ABS</b>	<b>KV 144</b>
<b>KF 143</b>		1.9 Estate Car	72	11.86-12.88		
<b>KF 139</b>	--> 12.82	1.9 Limousine	75	10.82-08.85	--> 12.82	<b>KA 088</b>
<b>KF 143</b>	09.84 --> / CH. 9404639 -->	1.9 Limousine	75	10.82-08.85		
		1.9 Limousine	75	10.82-08.85	--> 01.83	<b>KV 144</b>
<b>KF 143</b>		1.9 Estate Car	75	09.84-10.87		
<b>KF 139</b>	--> 12.82	1.9 D Limousine	47	10.82-07.88	--> 12.82	<b>KA 088</b>
<b>KF 143</b>	09.84 --> / CH. 9404639 -->	1.9 D Limousine	47	10.82-07.88		
		1.9 D Limousine	47	10.82-07.88	--> 01.83	<b>KV 144</b>
<b>KF 139</b>	--> 12.82	1.9 D Estate Car	47	10.82-12.88	--> 12.82	<b>KA 089</b>
<b>KF 143</b>	09.84 --> / CH. 9404639 -->	1.9 D Estate Car	47	10.82-12.88		
<b>KF 139</b>	--> 12.82	1.9 D Limousine	48	10.82-07.88	--> 12.82	<b>KA 088</b>
<b>KF 143</b>	09.84 --> / CH. 9404639 -->	1.9 D Limousine	48	10.82-07.88		
		1.9 D Limousine	48	10.82-07.88	--> 01.83	<b>KV 144</b>
<b>KF 139</b>	--> 12.82	1.9 D Estate Car	48	10.82-12.88	--> 12.82	<b>KA 089</b>
<b>KF 143</b>	09.84 --> / CH. 9404639 -->	1.9 D Estate Car	48	10.82-12.88		
<b>306</b>						
<b>KF 143</b>		1.1 Limousine; 1.1 XN Hatchback; 1.4 SL Limousine	44-55	05.93-05.01		
<b>KF 142</b>	<b>ABS</b> / --> 12.96	1.1 Limousine; 1.1 XN Hatchback; 1.4 SL Limousine	44-55	05.93-05.01		
<b>KF 143</b>	<b>ABS</b> / 01.97 -->	1.1 Limousine; 1.1 XN Hatchback; 1.4 SL Limousine	44-55	05.93-05.01		
<b>KF 142</b>	<b>ABS</b> / 01.97 -->	1.1 Limousine; 1.1 XN Hatchback; 1.4 SL Limousine	44-55	05.93-05.01		
<b>KF 145</b>	<b>ABS</b>	1.1 Limousine; 1.1 XN Hatchback; 1.4 SL Limousine	44-55	05.93-05.01		
		1.1 Limousine; 1.1 XN Hatchback; 1.4 SL Limousine	44-55	05.93-05.01	<b>ABS</b> / --> 06.95 / DRUM BRAKE	<b>KB 008</b>
		1.1 Limousine; 1.1 XN Hatchback; 1.4 SL Limousine	44-55	05.93-05.01	<b>ABS</b> / 07.95 -->	<b>KB 008</b>
<b>KF 143</b>	<b>ABS</b>	1.4 XN Hatchback	55	05.93-05.01		
<b>KF 142</b>	<b>ABS</b>	1.4 XN Hatchback	55	05.93-05.01		
		1.4 XN Hatchback	55	05.93-05.01	<b>DISC BRAKE</b>	<b>KV 219</b>
		1.4 XN Hatchback	55	05.93-05.01		<b>KB 008</b>
<b>KF 143</b>		1.4 Estate Car; 1.6 Estate Car	55-65	03.97-04.02	--> 09.98 / <b>DISC BRAKE</b>	<b>KV 219</b>
<b>KF 143</b>		1.4 Estate Car; 1.6 Estate Car	55-65	03.97-04.02	10.98 --> / <b>DISC BRAKE</b>	<b>KV 305</b>
<b>KF 143</b>	<b>ABS</b>	1.6 XR Hatchback	65	05.93-10.00		
<b>KF 142</b>	<b>ABS</b>	1.6 XR Hatchback	65	05.93-10.00		
		1.6 XR Hatchback	65	05.93-10.00	<b>DISC BRAKE</b>	<b>KV 219</b>
		1.6 XR Hatchback	65	05.93-10.00		<b>KB 008</b>
<b>KF 143</b>		1.6 SR Limousine	65	06.94-10.00	<b>ABS</b> / --> 06.95 / DRUM BRAKE	<b>KB 008</b>
<b>KF 143</b>		1.6 SR Limousine	65	06.94-10.00	<b>ABS</b> / 07.95 -->	<b>KB 008</b>
<b>KF 143</b>		1.6 SR Limousine	65	06.94-10.00		<b>KB 008</b>
<b>KF 143</b>		1.6 Convertible	65	04.96-10.00		<b>KV 219</b>
<b>KF 143</b>		1.6 Convertible	65	04.96-10.00		<b>KB 008</b>
<b>KF 143</b>	<b>ABS</b>	1.6	66	07.00-05.01		<b>KB 008</b>
<b>KF 142</b>	<b>ABS</b>	1.6	66	07.00-05.01		<b>KB 008</b>
<b>KF 145</b>	<b>ABS</b>	1.6	66	07.00-05.01		<b>KB 008</b>
<b>KF 142</b>		1.6	66	07.00-05.01		<b>KB 008</b>
		1.6	66	07.00-05.01		<b>KB 008</b>
<b>KF 143</b>	<b>ABS</b>	1.6 Limousine	72	10.00-05.01		<b>KB 008</b>
<b>KF 142</b>	<b>ABS</b>	1.6 Limousine	72	10.00-05.01		<b>KB 008</b>
<b>KF 145</b>	<b>ABS</b>	1.6 Limousine	72	10.00-05.01		<b>KB 008</b>

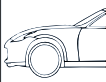
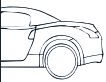
	<b>i</b>	<b>ENGINE</b>	<b>POWER (kW)</b>	<b>YEAR</b>	<b>i</b>	
Fersa KIT FRONT						Fersa KIT REAR
<b>PEUGEOT</b>						
<b>306</b>						
KF 142		1.6 Limousine	72	10.00-05.01		<b>KB 008</b>
		1.6 Limousine	72	10.00-05.01		<b>KB 008</b>
KF 143	ABS	1.6 Hatchback	72	10.00-05.01		<b>KB 008</b>
KF 142	ABS	1.6 Hatchback	72	10.00-05.01		<b>KB 008</b>
KF 145	ABS	1.6 Hatchback	72	10.00-05.01		<b>KB 008</b>
KF 142		1.6 Hatchback	72	10.00-05.01		<b>KB 008</b>
KF 143		1.6 Estate Car	72	10.00-04.02	DRUM BRAKE	<b>KV 305</b>
KF 143		1.6 Convertible	72	10.00-04.02	ABS / DISC BRAKE	<b>KV 219</b>
KF 143		1.6 Convertible	72	10.00-04.02		<b>KB 008</b>
		1.6 Convertible	72	10.00-04.02		<b>KB 008</b>
KF 143	ABS	1.8	74	05.97-04.99		<b>KB 008</b>
KF 142	ABS	1.8	74	05.97-04.99	ABS	<b>KB 008</b>
KF 145	ABS	1.8	74	05.97-04.99		<b>KB 008</b>
KF 143		1.8	74	05.97-04.99		<b>KB 008</b>
KF 143		1.8	74	05.97-04.99	DISC BRAKE	<b>KV 219</b>
KF 143		1.8 Limousine	81	03.97-05.01		<b>KB 008</b>
KF 143		1.8 Hatchback	81	03.97-05.01		<b>KB 008</b>
KF 143		1.8 Estate Car	81	03.97-04.02		<b>KB 008</b>
KF 143		1.8 Estate Car	81	03.97-04.02	--> 09.98 / DISC BRAKE	<b>KV 219</b>
KF 143		1.8 Estate Car	81	03.97-04.02	10.98 --> / DISC BRAKE	<b>KV 305</b>
KF 143		1.8 Convertible	81	07.00-04.02		<b>KB 008</b>
KF 143	ABS	1.8 XT Hatchback	74	05.93-05.01		<b>KV 219</b>
KF 142	ABS	1.8 XT Hatchback	74	05.93-05.01	ABS	<b>KB 008</b>
KF 143		1.8 Convertible	74	03.94-04.02		<b>KB 008</b>
KF 145		1.8 Convertible	74	03.94-04.02		<b>KB 008</b>
KF 143		1.8 ST Limousine	74	06.94-05.01		<b>KB 008</b>
KF 143		1.8 Estate Car	74	03.97-04.02	--> 09.98 / DISC BRAKE	<b>KV 219</b>
		1.8 Estate Car	74	03.97-04.02	10.98 --> / DISC BRAKE	<b>KV 305</b>
KF 143	ABS	2.0 XSi Hatchback	89	05.93-05.01		<b>KV 219</b>
KF 142	ABS	2.0 XSi Hatchback	89	05.93-05.01	ABS	<b>KB 008</b>
KF 143		2.0 Convertible	89	03.94-04.02		<b>KB 008</b>
KF 145	ABS	2.0 Convertible	89	03.94-04.02		<b>KB 008</b>
KF 143		2.0 ST Limousine	89	07.94-05.01		<b>KB 008</b>
KF 142	ABS / --> 12.96	2.0 ST Limousine	89	07.94-05.01		<b>KB 008</b>
KF 143	ABS / 01.97 -->	2.0 ST Limousine	89	07.94-05.01		<b>KB 008</b>
KF 142	ABS / 01.97 -->	2.0 ST Limousine	89	07.94-05.01		<b>KB 008</b>
KF 145	ABS	2.0 ST Limousine	89	07.94-05.01		<b>KB 008</b>
KF 142		2.0 ST Limousine	89	07.94-05.01		<b>KB 008</b>
KF 143		2.0 Limousine	97	03.97-05.01		<b>KB 008</b>
KF 143	ABS	2.0 Hatchback	97	03.97-05.01	DISC BRAKE	<b>KV 219</b>
KF 142	ABS	2.0 Hatchback	97	03.97-05.01	ABS	<b>KB 008</b>
KF 143	ABS	2.0 Hatchback	97	03.97-05.01		<b>KV 305</b>
KF 143		2.0 Estate Car	97	03.97-04.02	--> 09.98 / DISC BRAKE	<b>KV 219</b>
KF 143		2.0 Estate Car	97	03.97-04.02	10.98 --> / DISC BRAKE	<b>KV 305</b>
KF 143		2.0 Convertible	97	03.97-04.02		<b>KB 008</b>
KF 143		2.0 Convertible	97	03.97-04.02		<b>KV 219</b>
KF 143		2.0 S16 Limousine	110	06.94-05.01		<b>KB 008</b>
KF 142		2.0 S16 Hatchback	110	06.94-05.01		<b>KV 219</b>



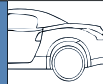

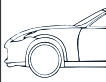
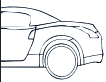
	<b>i</b>	ENGINE	POWER (kW)	YEAR	<b>i</b>	
Fersa KIT FRONT						Fersa KIT REAR
<b>PEUGEOT</b>						
<b>306</b>						
KF 142		2.0 S16 Hatchback	110	06.94-05.01		<b>KB 008</b>
KF 143		2.0 S16 Limousine	112	06.94-05.01		<b>KB 008</b>
KF 143	ABS	2.0 S16 Hatchback	112-120	05.93-05.01	ABS	<b>KV 219</b>
KF 142	ABS	2.0 S16 Hatchback	112-120	05.93-05.01	ABS	<b>KB 008</b>
KF 143	ABS	1.8 D Hatchback	43	05.93-05.01		
KF 142	ABS	1.8 D Hatchback	43	05.93-05.01		
		1.8 D Hatchback	43	05.93-05.01		<b>KV 219</b>
		1.8 D Hatchback	43	05.93-05.01	DRUM BRAKE	<b>KV 305</b>
		1.8 D Hatchback	43	05.93-05.01	DRUM BRAKE	<b>KB 008</b>
		1.8 D Hatchback	43	05.93-05.01	DRUM BRAKE	<b>KB 008</b>
		1.8 D Hatchback	43	05.93-05.01		<b>KB 008</b>
KF 143		1.8 D	44	05.97-06.00		<b>KB 008</b>
KF 142		1.8 D	44	05.97-06.00		<b>KB 008</b>
KF 143	ABS	1.8 D	44	05.97-06.00		<b>KB 008</b>
KF 142	ABS	1.8 D	44	05.97-06.00	ABS	<b>KB 008</b>
KF 145	ABS	1.8 D	44	05.97-06.00		<b>KB 008</b>
KF 143		1.8 XA	44	05.97-06.00	--> 09.98 / DISC BRAKE	<b>KV 219</b>
KF 143		1.8 XA	44	05.97-06.00	10.98 --> / DISC BRAKE	<b>KV 305</b>
KF 143		1.9 D Limousine	51	09.98-05.01	CH. --> 7958	<b>KB 008</b>
KF 143		1.9 D Limousine	51	09.98-05.01	CH. 7959 -->	<b>KB 008</b>
KF 143	ABS	1.9 D Hatchback	51	09.98-05.01	DISC BRAKE	<b>KV 219</b>
KF 143	ABS	1.9 D Hatchback	51	09.98-05.01		<b>KV 305</b>
KF 142	ABS	1.9 D Hatchback	51	09.98-05.01		<b>KB 008</b>
KF 143		1.9 D Estate Car	51	09.98-04.02		<b>KV 305</b>
KF 143	ABS	1.9 XND Hatchback	47	05.93-05.01		
KF 142	ABS	1.9 XND Hatchback	47	05.93-05.01		
		1.9 XND Hatchback	47	05.93-05.01		<b>KV 219</b>
		1.9 XND Hatchback	47	05.93-05.01		<b>KB 008</b>
KF 143		1.9 SLD Limousine	47	06.94-05.01		<b>KB 008</b>
KF 143		1.9 SLD Limousine	50	06.94-05.01		<b>KB 008</b>
KF 143	ABS	1.9 XND Hatchback	50	06.94-05.01	DISC BRAKE	<b>KV 219</b>
KF 142	ABS	1.9 XND Hatchback	50	06.94-05.01	ABS	<b>KB 008</b>
KF 143		1.9 D Estate Car	50	03.97-04.02	--> 09.98 / DISC BRAKE	<b>KV 219</b>
KF 143		1.9 D Estate Car	50	03.97-04.02	10.98 --> / DISC BRAKE	<b>KV 305</b>
KF 143		1.9 D	51	04.93-04.97		
KF 142	ABS / --> 12.96	1.9 D	51	04.93-04.97		<b>KB 008</b>
KF 143	ABS / 01.97 -->	1.9 D	51	04.93-04.97		<b>KB 008</b>
KF 142	ABS / 01.97 -->	1.9 D	51	04.93-04.97		<b>KB 008</b>
KF 145	ABS	1.9 D	51	04.93-04.97		<b>KB 008</b>
KF 142		1.9 D	51	04.93-04.97		<b>KB 008</b>
KF 143	ABS	1.9 STD	51	02.94-10.95		<b>KB 008</b>
KF 142	ABS	1.9 STD	51	02.94-10.95		<b>KB 008</b>
KF 143		1.9 STD	51	02.94-10.95		<b>KB 008</b>
KF 145	ABS	1.9 STD	51	02.94-10.95		<b>KB 008</b>
KF 142		1.9 STD	51	02.94-10.95		<b>KB 008</b>
KF 143		1.9 D	51	05.97-05.99	--> 09.98 / DISC BRAKE	<b>KV 219</b>
KF 143		1.9 D	51	05.97-05.99	10.98 --> / DISC BRAKE	<b>KV 305</b>
KF 143		1.9 D Limousine	55	03.98-05.01		<b>KV 219</b>

	<b>i</b>	ENGINE	POWER (kW)	YEAR	<b>i</b>	
Fersa KIT FRONT						Fersa KIT REAR
<b>PEUGEOT</b>						
<b>306</b>						
KF 143		1.9 D Limousine	55	03.98-05.01		<b>KB 008</b>
KF 142	<b>ABS</b>	1.9 D Hatchback	55	03.98-05.01		
KF 143	ABS	1.9 D Hatchback	55	03.98-05.01		<b>KV 219</b>
KF 143	ABS	1.9 D Hatchback	55	03.98-05.01		<b>KV 305</b>
KF 142	<b>ABS</b>	1.9 D Hatchback	55	03.98-05.01		<b>KB 008</b>
KF 143		1.9 D Estate Car	55	03.98-04.02	--> 09.98 / DISC BRAKE	<b>KV 219</b>
KF 143		1.9 D Estate Car	55	03.98-04.02	10.98 --> / DISC BRAKE	<b>KV 305</b>
KF 143	ABS	1.9 XRDT Hatchback	66	05.93-05.01		<b>KV 219</b>
KF 142	<b>ABS</b>	1.9 XRDT Hatchback	66	05.93-05.01		<b>KB 008</b>
KF 143		1.9 SRDT Limousine	66	06.94-05.01	ABS / --> 06.95 / DRUM BRAKE	<b>KB 008</b>
KF 143		1.9 SRDT Limousine	66	06.94-05.01	ABS / 07.95 -->	<b>KB 008</b>
KF 143		1.9 SRDT Limousine	66	06.94-05.01		<b>KB 008</b>
KF 143		1.9 TD Estate Car	66	02.97-04.02	--> 09.98 / DISC BRAKE	<b>KV 219</b>
KF 143		1.9 TD Estate Car	66	02.97-04.02	10.98 --> / DISC BRAKE	<b>KV 305</b>
KF 143	ABS	1.9 D	69	04.93-04.97		<b>KB 008</b>
KF 142	<b>ABS</b> / --> 12.96	1.9 D	69	04.93-04.97		<b>KB 008</b>
KF 143	ABS / 01.97 -->	1.9 D	69	04.93-04.97		<b>KB 008</b>
KF 142	<b>ABS</b> / 01.97 -->	1.9 D	69	04.93-04.97		<b>KB 008</b>
KF 145	<b>ABS</b>	1.9 D	69	04.93-04.97		<b>KB 008</b>
KF 142		1.9 D	69	04.93-04.97		<b>KB 008</b>
KF 143		2.0 HDI 90 Limousine	66	06.99-05.01	DISC BRAKE	<b>KV 219</b>
KF 143		2.0 HDI 90 Limousine	66	06.99-05.01		<b>KB 008</b>
KF 143	ABS	2.0 HDI 90 Hatchback	66	06.99-05.01		<b>KB 008</b>
KF 142	<b>ABS</b>	2.0 HDI 90 Hatchback	66	06.99-05.01		<b>KB 008</b>
KF 145	<b>ABS</b>	2.0 HDI 90 Hatchback	66	06.99-05.01		<b>KB 008</b>
KF 142		2.0 HDI 90 Hatchback	66	06.99-05.01		<b>KB 008</b>
KF 143		2.0 HDI 90 Estate Car	66	06.99-04.02		<b>KV 305</b>
KF 289		1.4	55	08.00-		
KF 289		1.4	55	04.02-09.03		
KF 289		1.4; 1.4 16V; 1.6; 2.0; 2.0 16V	65-130	08.00-		
KF 289		1.6 BioFlex	80	09.07-		
KF 289		1.4 HDi	50	10.01-		
<b>307</b>						
KF 289		1.6 D	66	12.06-		
KF 289		1.6 HDi; 1.6 HDi 110 FAP; 2.0 HDi 110; 2.0 HDi 110 FAP; 2.0 HDi 135 FAP; 2.0 HDi 90	66-100	08.00-		
<b>309 I (10C,10A)</b>						
KF 142		1.1; 1.3	40-47	10.85-07.89		<b>KB 008</b>
KF 143		1.4; 1.5; 1.6; 1.9	49-80	10.85-12.89		<b>KB 008</b>
KF 143		1.9; 1.9 GTI	88-94	10.86-07.89		
KF 143		1.9 D	47	06.86-07.89		<b>KB 008</b>
KF 142		1.1; 1.4	44-55	07.89-12.93		<b>KB 008</b>
KF 143		1.6; 1.9	65-80	07.89-12.93		<b>KB 008</b>
KF 143		1.9 GTI; 1.9 GTI 16V	88-116	07.89-12.93		
KF 143		1.8 Diesel; 1.8 TD; 1.9 D	44-57	07.89-12.93		<b>KB 008</b>
<b>405 I</b>						
KF 143		1.4 Limousine; 1.6 Limousine; 1.6 Estate Car; 1.9 Limousine; 1.9 Estate Car; 1.9 INJECTION Limousine; 1.9 SPORT MI 16 Limousine	47-116	01.87-12.93	ABS	<b>KV 215</b>
KF 143		1.4 Limousine; 1.6 Limousine; 1.6 Estate Car; 1.9 Limousine; 1.9 Estate Car; 1.9 INJECTION Limousine; 1.9 SPORT MI 16 Limousine	47-116	01.87-12.93		<b>KV 144</b>

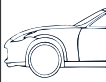
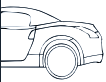
	<b>i</b>	<b>ENGINE</b>	<b>POWER (kW)</b>	<b>YEAR</b>	<b>i</b>	
Fersa KIT FRONT						Fersa KIT REAR
<b>PEUGEOT</b>						
<b>405 I</b>						
<b>KF 143</b>		1.9 4x4 Limousine; 1.9 4x4 Estate Car; 1.9 SPORT MI 16 4x4 Limousine	80-108	04.88-12.92		<b>KF 143</b>
<b>KF 143</b>		1.8 TD Limousine; 1.8 TD Estate Car; 1.9 D Limousine; 1.9 D Estate Car	47-66	03.88-12.92	ABS	<b>KV 215</b>
<b>KF 143</b>		1.8 TD Limousine; 1.8 TD Estate Car; 1.9 D Limousine; 1.9 D Estate Car	47-66	03.88-12.92		<b>KV 144</b>
<b>405 II</b>						
<b>KF 143</b>		1.4; 1.6; 1.8; 2.0; 2.0 16V; 2.0 MI 16	55-112	08.92-10.96	ABS	<b>KV 215</b>
<b>KF 143</b>		1.4; 1.6; 1.8; 2.0; 2.0 16V; 2.0 MI 16	55-112	08.92-10.96		<b>KV 144</b>
<b>KF 143</b>		2.0 4x4; 2.0 T 16 X4; 2.0 X4	89-144	08.92-10.96		<b>KF 143</b>
<b>KF 143</b>		1.9 D; 1.9 TD	47-66	08.92-10.96	ABS	<b>KV 215</b>
<b>KF 143</b>		1.9 D; 1.9 TD	47-66	08.92-10.96		<b>KV 144</b>
<b>406</b>						
<b>KF 143</b>		1.6	65	11.95-05.04	ABS	<b>KV 114</b>
<b>KF 143</b>		1.8; 1.8 16V; 1.8 16V Estate Car; 1.8 BREAK Estate Car; 2.0 16V Limousine; 2.0 16V Estate Car; 2.0 16V Coupe	66-99	11.95-10.04	ABS	<b>KV 114</b>
<b>KF 143</b>		2.0 Limousine; 2.0 16V Estate Car; 2.0 16V Coupe; 2.0 TURBO Limousine; 2.0 TURBO Estate Car	97-108	11.95-12.04	ABS	<b>KV 114</b>
<b>KF 143</b>		2.9 24V Estate Car; 3.0 V6 24V Coupe	140	10.96-12.04	ABS	<b>KV 114</b>
<b>KF 143</b>		3.0 V6 Estate Car; 3.0 V6 Coupe	152	03.00-12.04		
<b>KF 143</b>		1.9 D Limousine; 1.9 D Estate Car; 1.9 TD Limousine; 1.9 TD Estate Car; 2.0 HDi 90 Limousine; 2.0 HDi 90 Estate Car	55-68	01.96-10.04		
<b>KF 143</b>		1.9 D Limousine; 1.9 D Estate Car; 1.9 TD Limousine; 1.9 TD Estate Car; 2.0 HDi 90 Limousine; 2.0 HDi 90 Estate Car	55-68	01.96-10.04	ABS	<b>KV 114</b>
<b>KF 143</b>		2.0 HDi 110 FAP Limousine; 2.0 HDi 110 FAP Estate Car	79	08.01-10.04		
<b>KF 143</b>		2.0 HDi Limousine; 2.0 HDi Estate Car; 2.1 TD 12V Limousine; 2.1 TD 12V Estate Car	80	01.96-10.04	ABS	<b>KV 114</b>
<b>KF 143</b>		2.2 HDi Estate Car; 2.2 HDi Coupe	98	03.00-12.04		
<b>504</b>						
<b>KA 041</b>	CH. 2181357 -->	1.6 Pick-Up; 1.8 (F01,E01) Estate Car	46-54	04.71-06.87		
<b>KA 041</b>	CH. 2181357 -->	1.8 (M03) Limousine	58	01.71-06.83		
		1.8 (A01,A03) Limousine; 1.8 INJECTION (A02) Limousine	60-71	07.68-02.71		<b>KF 140</b>
<b>KA 041</b>	CH. 2181357 -->	2.0 (D11,F11) Estate Car	68	04.71-07.86		
<b>KA 041</b>	CH. 2181357 -->	2.0 (A11,A13,MY1,MY3) Limousine	71	03.71-06.86		
<b>KA 041</b>	CH. 2181357 -->	2.0 Coupe; 2.0 Convertible	75-78	10.74-08.84		
		2.0 Coupe; 2.0 Convertible	75-78	10.74-08.84	CH. --> 3547547	<b>KF 140</b>
		2.0 Coupe; 2.0 Convertible	75-78	10.74-08.84	CH. 3547548 -->	<b>KF 141</b>
<b>KA 041</b>	CH. 2181357 -->	2.0 Ti (A12,A14) Limousine	78	01.71-06.83		
<b>KA 041</b>	CH. 2181357 -->	2.7 Coupe	106	10.77-08.84		
		2.7 Coupe	106	10.77-08.84	CH. --> 3547547	<b>KF 140</b>
		2.7 Coupe	106	10.77-08.84	CH. 3547548 -->	<b>KF 141</b>
<b>KA 041</b>	CH. 2181357 -->	1.9 D Pick-Up	40	01.80-12.89		
<b>KA 041</b>	CH. 2181357 -->	1.9 D (M20) Limousine; 2.1 D (A20,M20) Limousine	40-48	02.71-07.86		
		1.9 D (M20) Limousine; 2.1 D (A20,M20) Limousine	40-48	02.71-07.86		<b>KF 140</b>
<b>KA 041</b>	CH. 2181357 -->	2.1 D (E20,F20) Estate Car; 2.3 D Pick-Up	48-51	04.71-12.89		
<b>KA 041</b>	CH. 2181357 -->	2.3 D (A40,A45) Limousine	51	07.75-12.83		
		2.3 D (A40,A45) Limousine	51	07.75-12.83		<b>KF 140</b>
<b>KA 041</b>	CH. 2181357 -->	2.3 D (D40,F40) Estate Car	51	07.75-07.86		
<b>505</b>						
<b>KA 041</b>	<b>ABS</b>	1.8 Limousine	55-62	06.81-10.86		<b>KF 141</b>
<b>KA 041</b>	<b>ABS</b>	2.0 Estate Car	60-69	04.82-11.87		

	<b>i</b>	<b>ENGINE</b>	<b>POWER (kW)</b>	<b>YEAR</b>	<b>i</b>	
Fersa KIT FRONT						Fersa KIT REAR
<b>PEUGEOT</b>						
<b>505</b>						
KA 041	ABS	2.0 Limousine	71	11.80-12.85	--> 12.80 / CH. --> 1214586	<b>KF 140</b>
KA 041	ABS	2.0 Limousine	71	11.80-12.85	01.81 --> / CH. 1214587 -->	<b>KF 141</b>
KA 041	ABS	2.0 Limousine	72	09.85-09.91		<b>KF 141</b>
KA 041	ABS	2.0 Ti,STi Limousine	81	08.79-10.86	--> 12.80 / CH. --> 1214586	<b>KF 140</b>
KA 041	ABS	2.0 Ti,STi Limousine	81	08.79-10.86	01.81 --> / CH. 1214587 -->	<b>KF 141</b>
KA 041	ABS	2.2 Limousine; 2.2 TURBO INJECTION Limousine	84-128	03.84-12.93		<b>KF 141</b>
KA 041	ABS	2.2 Estate Car	84	01.86-12.93		
KA 041	ABS	2.2 Limousine; 2.2 GTI Limousine	85-90	05.81-12.93		<b>KF 141</b>
KA 041	ABS	2.2 GTI Estate Car	90	09.85-12.86		
KA 041	ABS / --> 12.92	2.2 GTI Limousine	96	08.83-12.93	ABS / --> 12.92	<b>KF 141</b>
KA 041	ABS	2.8 GTI V6 Limousine	105	06.86-12.93		<b>KF 141</b>
KA 041	ABS	2.3 TD Limousine	59	09.80-06.86	--> 12.80 / CH. --> 1214586	<b>KF 140</b>
KA 041	ABS	2.3 TD Limousine	59	09.80-06.86	01.81 --> / CH. 1214587 -->	<b>KF 141</b>
KA 041	ABS	2.3 Diesel Estate Car	59	04.82-06.86		
KA 041	ABS	2.5 D Limousine	51	10.81-11.90		<b>KF 141</b>
KA 041	ABS	2.5 D Limousine	55	06.81-12.93		<b>KF 141</b>
KA 041	ABS	2.5 TD Limousine	66	10.83-12.93		<b>KF 141</b>
KA 041	ABS	2.5 TD Limousine	70-77	10.83-12.93		<b>KF 141</b>
KA 041	ABS	2.5 TD Estate Car	77	10.86-12.93		
<b>604</b>						
KA 041	ABS	2.6 SL; 2.6 Ti,Sti	100-106	08.77-05.83	--> 12.80 / CH. --> 6640835	<b>KF 140</b>
KA 041	ABS	2.6 SL; 2.6 Ti,Sti	100-106	08.77-05.83	01.81--> / CH. 6640836 -->	<b>KF 141</b>
KA 041	ABS	2.8 GTI	110	09.83-07.87		<b>KF 141</b>
KA 041	ABS	2.3 TD; 2.5 TD	59-66	09.79-12.86		<b>KF 141</b>
<b>605</b>						
KF 313	05.97 --> / CH. 7469 -->	2.0	79-89	06.89-09.99		
KF 313	05.97 --> / CH. 7469 -->	2.0 16V; 2.0 TURBO	97-108	07.91-09.99		
KF 313		3.0 V6	140	04.97-09.99		
KF 313	05.97 --> / CH. 7469 -->	3.0; 3.0 SV 24	123-147	08.89-09.99		
KF 313	05.97 --> / CH. 7469 -->	2.1 TD	80	06.89-09.99		
KF 313	05.97 --> / CH. 7469 -->	2.1 TD 12V	80	08.94-09.99		
KF 313	05.97 --> / CH. 7469 -->	2.5 TD	95	07.94-09.99		
<b>607</b>						
KF 313	--> 12.04	2.0; 2.2 16V	100-116	02.00-		
KF 313	--> 12.04	3.0 V6 24V	152-155	02.00-		
KF 313		2.0 HDi	79	03.01-07.04		
KF 313	--> 12.04	2.0 HDi	80	05.00-		
KF 313	--> 12.04	2.2 HDi	98	02.00-		
<b>806</b>						
KF 113		1.8; 2.0; 2.0 16V; 2.0 TURBO	73-108	06.94-08.02	ABS	<b>KV 236</b>
KF 113		1.9 TD; 2.0 HDi; 2.1 TD 12V	66-80	07.95-08.02	ABS	<b>KV 236</b>
<b>807</b>						
		2.0; 2.2	100-116	06.02-		<b>KV 294</b>
KA 091		3.0 V6	150	06.02-		<b>KV 294</b>
		2.0 HDi FAP; 2.2 HDi FAP	79-94	06.02-		<b>KV 294</b>
<b>BOXER (230)</b>						
KA 079	--> 11.01 / 1000*1400[kg]	2.0i Bus; 2.0i Bus; 2.0i Platform	80	03.94-04.02	--> 11.01 / 1000*1400[kg]	<b>KA 013</b>

	<b>i</b>	<b>ENGINE</b>	<b>POWER (kW)</b>	<b>YEAR</b>	<b>i</b>	
Fersa KIT FRONT						Fersa KIT REAR
<b>PEUGEOT</b>						
<b>BOXER (230)</b>						
<b>KA 272</b>	--> 11.01 / 1800[kg]	2.0i Bus; 2.0i Bus; 2.0i Platform	80	03.94-04.02	--> 11.01 / 1800[kg]	<b>KA 080</b>
<b>KA 079</b>	12.01 --> / 1000*1400[kg]	2.0i Bus; 2.0i Bus; 2.0i Platform	80	03.94-04.02		
<b>KA 272</b>	12.01 --> / 1800[kg]	2.0i Bus; 2.0i Bus; 2.0i Platform	80	03.94-04.02		
<b>KA 079</b>	--> 11.01 / 1000*1400[kg]	2.0i 4x4 Bus	80	08.96-04.02	--> 11.01 / 1000*1400[kg]	<b>KA 079</b>
<b>KA 272</b>	--> 11.01 / 1800[kg]	2.0i 4x4 Bus	80	08.96-04.02		
<b>KA 079</b>	12.01 --> / 1000*1400[kg]	2.0i 4x4 Bus	80	08.96-04.02		
<b>KA 272</b>	12.01 --> / 1800[kg]	2.0i 4x4 Bus	80	08.96-04.02		
<b>KA 079</b>	--> 11.01 / 1000*1400[kg]	1.9 D Bus; 1.9 D Bus; 1.9 TD Bus; 1.9 TD Bus; 1.9 TD Platform	50-68	03.94-04.02	--> 11.01 / 1000*1400[kg]	<b>KA 013</b>
<b>KA 272</b>	--> 11.01 / 1800[kg]	1.9 D Bus; 1.9 D Bus; 1.9 TD Bus; 1.9 TD Bus; 1.9 TD Platform	50-68	03.94-04.02	--> 11.01 / 1800[kg]	<b>KA 080</b>
<b>KA 079</b>	12.01 --> / 1000*1400[kg]	1.9 D Bus; 1.9 D Bus; 1.9 TD Bus; 1.9 TD Bus; 1.9 TD Platform	50-68	03.94-04.02		
<b>KA 272</b>	12.01 --> / 1800[kg]	1.9 D Bus; 1.9 D Bus; 1.9 TD Bus; 1.9 TD Bus; 1.9 TD Platform	50-68	03.94-04.02		
<b>KA 079</b>	--> 11.01 / 1000*1400[kg]	1.9 TD 4x4 Bus	68	07.96-04.02	--> 11.01 / 1000*1400[kg]	<b>KA 079</b>
<b>KA 272</b>	--> 11.01 / 1800[kg]	1.9 TD 4x4 Bus	68	07.96-04.02		
<b>KA 079</b>	12.01 --> / 1000*1400[kg]	1.9 TD 4x4 Bus	68	07.96-04.02		
<b>KA 272</b>	12.01 --> / 1800[kg]	1.9 TD 4x4 Bus	68	07.96-04.02		
<b>KA 079</b>	--> 11.01 / 1000*1400[kg]	2.0 HDi Bus; 2.4 D Bus; 2.4 D Bus; 2.4 D Platform; 2.4 TD Bus; 2.4 TD Bus; 2.4 TD Platform; 2.4 TDI Bus; 2.4 TDI Bus; 2.4 TDI Platform	62-79	03.94-04.02	--> 11.01 / 1000*1400[kg]	<b>KA 013</b>
<b>KA 272</b>	--> 11.01 / 1800[kg]	2.0 HDi Bus; 2.4 D Bus; 2.4 D Bus; 2.4 D Platform; 2.4 TD Bus; 2.4 TD Bus; 2.4 TD Platform; 2.4 TDI Bus; 2.4 TDI Bus; 2.4 TDI Platform	62-79	03.94-04.02	--> 11.01 / 1800[kg]	<b>KA 080</b>
<b>KA 079</b>	12.01 --> / 1000*1400[kg]	2.0 HDi Bus; 2.4 D Bus; 2.4 D Bus; 2.4 D Platform; 2.4 TD Bus; 2.4 TD Bus; 2.4 TD Platform; 2.4 TDI Bus; 2.4 TDI Bus; 2.4 TDI Platform	62-79	03.94-04.02		
<b>KA 272</b>	12.01 --> / 1800[kg]	2.0 HDi Bus; 2.4 D Bus; 2.4 D Bus; 2.4 D Platform; 2.4 TD Bus; 2.4 TD Bus; 2.4 TD Platform; 2.4 TDI Bus; 2.4 TDI Bus; 2.4 TDI Platform	62-79	03.94-04.02		
<b>KA 079</b>	--> 11.01 / 1000*1400[kg]	2.4 D 4x4 Bus; 2.4 D 4x4 Bus; 2.4 D 4x4 Platform; 2.4 TD 4x4 Bus; 2.4 TDI 4x4 Bus; 2.4 TDI 4x4 Bus; 2.4 TDI 4x4 Platform	63-79	07.96-04.02	--> 11.01 / 1000*1400[kg]	<b>KA 079</b>
<b>KA 272</b>	--> 11.01 / 1800[kg]	2.4 D 4x4 Bus; 2.4 D 4x4 Bus; 2.4 D 4x4 Platform; 2.4 TD 4x4 Bus; 2.4 TDI 4x4 Bus; 2.4 TDI 4x4 Bus; 2.4 TDI 4x4 Platform	63-79	07.96-04.02		
<b>KA 079</b>	12.01 --> / 1000*1400[kg]	2.4 D 4x4 Bus; 2.4 D 4x4 Bus; 2.4 D 4x4 Platform; 2.4 TD 4x4 Bus; 2.4 TDI 4x4 Bus; 2.4 TDI 4x4 Bus; 2.4 TDI 4x4 Platform	63-79	07.96-04.02		
<b>KA 272</b>	12.01 --> / 1800[kg]	2.4 D 4x4 Bus; 2.4 D 4x4 Bus; 2.4 D 4x4 Platform; 2.4 TD 4x4 Bus; 2.4 TDI 4x4 Bus; 2.4 TDI 4x4 Bus; 2.4 TDI 4x4 Platform	63-79	07.96-04.02		
<b>KA 079</b>	--> 11.01 / 1000*1400[kg]	2.8 HDi Bus; 2.8 HDi Bus; 2.8 HDi Platform	94	11.00-04.02	--> 11.01 / 1000*1400[kg]	<b>KA 013</b>
<b>KA 272</b>	--> 11.01 / 1800[kg]	2.8 HDi Bus; 2.8 HDi Bus; 2.8 HDi Platform	94	11.00-04.02	--> 11.01 / 1800[kg]	<b>KA 080</b>
<b>KA 079</b>	12.01 --> / 1000*1400[kg]	2.8 HDi Bus; 2.8 HDi Bus; 2.8 HDi Platform	94	11.00-04.02		
<b>KA 272</b>	12.01 --> / 1800[kg]	2.8 HDi Bus; 2.8 HDi Bus; 2.8 HDi Platform	94	11.00-04.02		
<b>BOXER (244)</b>						
<b>KA 079</b>	--> 05.04 / 1100*1500[kg]	2.0 Bus; 2.0 Bus	81	04.02-		
<b>KA 272</b>	--> 05.04 / 1800[kg]	2.0 Bus; 2.0 Bus	81	04.02-		
<b>KA 079</b>	--> 05.04 / 1100*1500[kg]	2.0 HDi Bus; 2.0 HDi Bus; 2.0 HDi Platform; 2.2 HDi Bus; 2.2 HDi Bus; 2.2 HDi Platform; 2.8 HDi; 2.8 HDi Bus; 2.8 HDi Bus; 2.8 HDi Platform	62-107	04.02-		
<b>KA 272</b>	--> 05.04 / 1800[kg]	2.0 HDi Bus; 2.0 HDi Bus; 2.0 HDi Platform; 2.2 HDi Bus; 2.2 HDi Bus; 2.2 HDi Platform; 2.8 HDi; 2.8 HDi Bus; 2.8 HDi Bus; 2.8 HDi Platform	62-107	04.02-		

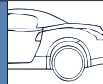

	<b>i</b>	<b>ENGINE</b>	<b>POWER (kW)</b>	<b>YEAR</b>	<b>i</b>	
Fersa KIT FRONT						Fersa KIT REAR
<b>PEUGEOT</b>						
<b>BOXER (244)</b>						
<b>KA 079</b>	--> 05.04 / 1100*1500[kg]	2.8 HDi 4x4 Bus; 2.8 HDi 4x4 Bus; 2.8 HDi 4x4 Platform	94	04.02-		
<b>KA 272</b>	--> 05.04 / 1800[kg]	2.8 HDi 4x4 Bus; 2.8 HDi 4x4 Bus; 2.8 HDi 4x4 Platform	94	04.02-		
<b>EXPERT</b>						
<b>KF 113</b>		1.6	58	02.96-	ABS	<b>KV 236</b>
<b>KF 113</b>		1.9 D; 1.9 TD	51-68	02.96-	ABS	<b>KV 236</b>
<b>KF 113</b>		1.9 D; 1.9 TD	51-68	02.96-		
<b>J5 (280)</b>						
<b>KA 009</b>	CH. --> 604496	1.8 Bus; 2.0 Bus; 2.0 Platform	51-58	09.81-09.90		
<b>KA 079</b>	CH. 604497 -->	1.8 Bus; 2.0 Bus; 2.0 Platform	51-58	09.81-09.90		
		1.8 Bus; 2.0 Bus; 2.0 Platform	51-58	09.81-09.90	CH. --> 278757 / 1000*1300[kg]	<b>KA 010</b>
		1.8 Bus; 2.0 Bus; 2.0 Platform	51-58	09.81-09.90	CH. 278758--> / 1000[kg]	<b>KA 058</b>
		1.8 Bus; 2.0 Bus; 2.0 Platform	51-58	09.81-09.90	1400[kg]	<b>KA 058</b>
		1.8 Bus; 2.0 Bus; 2.0 Platform	51-58	09.81-09.90	1800[kg]	<b>KA 200</b>
<b>KA 009</b>	CH. --> 604496	2.5 D Bus; 2.5 D Platform	54	09.81-09.90		
<b>KA 079</b>	CH. 604497 -->	2.5 D Bus; 2.5 D Platform	54	09.81-09.90		
		2.5 D Bus; 2.5 D Platform	54	09.81-09.90	CH. --> 278757 / 1000*1300[kg]	<b>KA 010</b>
		2.5 D Bus; 2.5 D Platform	54	09.81-09.90	CH. 278758--> / 1000[kg]	<b>KA 058</b>
		2.5 D Bus; 2.5 D Platform	54	09.81-09.90	1400[kg]	<b>KA 058</b>
		2.5 D Bus; 2.5 D Platform	54	09.81-09.90	1800[kg]	<b>KA 200</b>
<b>J5 (290)</b>						
<b>KA 079</b>		2.0 Bus; 2.0 Platform	62	10.90-	1000*1400[kg]	<b>KA 058</b>
<b>KA 079</b>		2.0 Bus; 2.0 Platform	62	10.90-	1800[kg]	<b>KA 200</b>
<b>KA 079</b>		1.9 D Bus; 1.9 D Bus; 1.9 D Platform; 2.5 D Bus; 2.5 D Platform; 2.5 TD Bus; 2.5 TD Platform	51-70	10.90-	1000*1400[kg]	<b>KA 058</b>
<b>KA 079</b>		1.9 D Bus; 1.9 D Bus; 1.9 D Platform; 2.5 D Bus; 2.5 D Platform; 2.5 TD Bus; 2.5 TD Platform	51-70	10.90-	1800[kg]	<b>KA 200</b>
<b>KA 079</b>		2.5 D 4x4 Bus; 2.5 D 4x4 Bus; 2.5 D 4x4 Platform; 2.5 TD 4x4 Bus; 2.5 TD 4x4 Bus; 2.5 TD 4x4 Platform	54-70	10.90-		
<b>PARTNER</b>						
<b>KF 143</b>		Electric	25	04.96-12.02	ABS	<b>KV 114</b>
<b>KF 143</b>		1.1 Bus; 1.1 Saloon Car	44	06.96-	ABS	<b>KV 114</b>
<b>KF 143</b>		1.4; 1.4 BiFuel Bus	54	11.02-	ABS	<b>KV 114</b>
<b>KF 143</b>		1.4 Bus; 1.4 Saloon Car	55	06.96-	ABS	<b>KV 114</b>
<b>KF 143</b>		1.6	80	09.00-10.02	ABS	<b>KV 114</b>
<b>KF 143</b>		1.6 16V Saloon Car	80	07.01-	ABS	<b>KV 114</b>
<b>KF 143</b>		1.8	66	03.97-08.00	ABS	<b>KV 114</b>
<b>KF 143</b>		1.8 Saloon Car	66	05.97-	ABS	<b>KV 114</b>
<b>KF 143</b>		1.6 HDi 75; 1.6 HDi 90	55-66	02.06-	ABS	<b>KV 114</b>
<b>KF 143</b>		1.8 D Bus	43	06.96-	ABS	<b>KV 114</b>
<b>KF 143</b>		1.8 D	44	11.96-02.98	ABS	<b>KV 114</b>
<b>KF 143</b>		1.9 D Bus	51	06.96-	ABS	<b>KV 114</b>
<b>KF 143</b>		1.9 D Saloon Car; 1.9 D 4x4; 1.9 D 4x4 Bus	51	12.98-	ABS	<b>KV 114</b>
<b>KF 143</b>		1.9 D	50	05.96-12.98	ABS	<b>KV 114</b>
<b>KF 143</b>		1.9 D Bus; 1.9 D Saloon Car	50	06.96-	ABS	<b>KV 114</b>
<b>KF 143</b>		1.9 D	51	05.96-12.98	ABS	<b>KV 114</b>
<b>KF 143</b>		2.0 HDi Bus; 2.0 HDi Saloon Car; 2.0 HDi 4x4; 2.0 HDi 4x4 Bus	66	02.00-	ABS	<b>KV 114</b>

	<b>i</b>	<b>ENGINE</b>	<b>POWER (kW)</b>	<b>YEAR</b>	<b>i</b>	
Fersa KIT FRONT						Fersa KIT REAR
<b>PORCHE</b>						
924						
KA 069		2.0, 2.5S	92	11.75-08.89		
<b>RENAULT</b>						
4						
KC 148		0.8; 1.1	21-26	10.76-07.89		KA 044
KC 148		0.8	20	01.81-09.82		KA 044
KC 146		0.8	19	10.62-09.83		KA 042
KC 148		0.8	21	10.83-10.88		KA 044
KC 146	--> 09.75	0.8	25	09.71-12.88		
KC 148	10.75 -->	0.8	25	09.71-12.88		
		0.8	25	09.71-12.88	--> 10.76	KA 042
		0.8	25	09.71-12.88	11.76 -->	KA 044
KC 148		1.0; 1.1	25-32	06.78-06.93		KA 044
KF 151		1.1 F (R2370)	25	77-86		KA 044
5						
KC 146	--> 09.75	0.8 Hatchback	26	10.72-08.84		
KC 148	10.75 -->	0.8 Hatchback	26	10.72-08.84		
		0.8 Hatchback	26	10.72-08.84	--> 10.76	KA 042
		0.8 Hatchback	26	10.72-08.84	11.76 -->	KA 044
KB 048		0.8 Bus	26	10.72-08.84		KB 046
		0.8 Bus	26	10.72-08.84		KB 046
KC 148		0.8 Hatchback	27	01.82-12.84		KA 044
KC 146	--> 09.75	1.0 Hatchback	32	01.72-12.85		
KC 148	10.75 -->	1.0 Hatchback	32	01.72-12.85		
		1.0 Hatchback	32	01.72-12.85	--> 10.76	KA 042
		1.0 Hatchback	32	01.72-12.85	11.76 -->	KA 044
KB 048		1.0 Bus	32	01.72-12.85		KB 046
KC 148		1.1 Hatchback	33	09.80-12.85		KA 044
KB 048		1.1 Bus	33	09.80-12.85		KB 046
KF 151		1.1 (S401)	33	85-92		KB 045
KC 148		1.3 Hatchback	31	09.76-09.79		KA 044
KB 048		1.3 Bus	32	03.76-08.82		KB 046
KC 148		1.3 Hatchback; 1.4 Hatchback; 1.4 Automatik Hatchback	33-47	09.75-12.85		KA 044
KC 149		1.4 Alpine A5 Hatchback	68	09.77-09.81		KA 044
KC 149		1.4 Alpine Turbo Hatchback; 1.4 TURBO Hatchback	79-118	06.80-01.85		KA 043
6						
KC 146	--> 09.75	0.8; 1.1	25-33	10.69-04.87		
KC 148	10.75 --> / --> 12.79	0.8; 1.1	25-33	10.69-04.87		
		0.8; 1.1	25-33	10.69-04.87	11.76 --> / --> 12.79	KA 044
KC 146	CH. --> 586727	1.1	35	07.71-04.80	CH. --> 586727	KA 043
KC 148	CH. 586728 -->	1.1	35	07.71-04.80	CH. 586728 -->	KA 044
		1.1	35	07.71-04.80	CH. --> 565497	KA 042
		1.1	35	07.71-04.80	CH. 565498 -->	KA 044
8						
KA 042		1.0, 1.1 (R1130, R1132)	35	65-73		
9						
KB 048		1.1; 1.3; 1.4; 1.4 Automatik; 1.7	35-69	09.81-12.88		KB 045

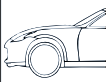
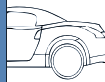

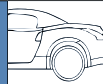

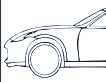
	<b>i</b>	<b>ENGINE</b>	<b>POWER (kW)</b>	<b>YEAR</b>	<b>i</b>	
Fersa KIT FRONT						Fersa KIT REAR
<b>RENAULT</b>						
<b>9</b>						
<b>KB 048</b>		1.6 D	40	10.82-12.88		<b>KB 045</b>
<b>KF 151</b>		1.1 C,TC,GTC,TCE (L421)	35	82-89		<b>KB 045</b>
<b>11</b>						
<b>KB 048</b>		1.1 Hatchback	35	03.83-06.86		<b>KB 045</b>
<b>KB 048</b>		1.1 Hatchback	35	03.83-06.86		
<b>KB 048</b>		1.1 Bus	35	03.83-06.86		<b>KB 045</b>
<b>KB 048</b>		1.2 Hatchback	40	10.84-12.88		<b>KB 045</b>
<b>KB 048</b>		1.2 Bus	40	10.84-12.88		<b>KB 090</b>
<b>KF 151</b>		1.2 (L42S,B37S,C37S)	40	85-87		<b>KB 045</b>
<b>KF 151</b>		1.4 GTE,GTL,GTS,TSE(L422,423)	44	82-89		<b>KB 045</b>
<b>KB 048</b>		1.4 Hatchback	44	03.83-12.88		<b>KB 045</b>
<b>KB 048</b>		1.4 Bus	44	03.83-09.86		<b>KB 090</b>
<b>KB 048</b>		1.4 Hatchback	49-50	03.83-12.88		<b>KB 045</b>
<b>KB 048</b>		1.4 Bus	50	03.83-12.86		<b>KB 090</b>
<b>KB 048</b>		1.4 Hatchback	53	05.83-12.85		<b>KB 045</b>
<b>KB 048</b>		1.4 Turbo Hatchback	77-85	04.84-12.88		<b>KB 090</b>
<b>KF 151</b>		1.4 TXE, Turbo (L425)	77-85	85-89		<b>KB 090</b>
<b>KF 151</b>		1.7 D GTD (L424)	54-69	85-89		<b>KB 045</b>
<b>KF 151</b>		1.7 GTX,TXE (L426)	54-69	86-89		<b>KB 045</b>
<b>KB 048</b>		1.7 Hatchback	54-69	10.83-12.88		<b>KB 045</b>
<b>KB 048</b>		1.6 D Hatchback	40	08.83-12.88		<b>KB 045</b>
<b>KB 048</b>		1.6 D Bus	40	08.83-12.88		<b>KB 090</b>
<b>12</b>						
<b>KC 147</b>		1.3 L, TL (R1170)	37	70-79		<b>KA 043</b>
<b>KC 147</b>		1.3 L,TL (R1171)	37	70-77		<b>KA 043</b>
<b>KC 147</b>		1.3 L, TL, LN, TN (R 1330)	37	70-80		<b>KA 043</b>
<b>KC 147</b>		1.3 TR,TS (R1177)	37	70-79		<b>KA 043</b>
<b>KC 149</b>	11.77 -->	1.3 Limousine	37	07.75-04.80		
		1.3 Limousine	37	07.75-04.80	--> 10.76	<b>KA 043</b>
		1.3 Limousine	37	07.75-04.80	11.76 -->	<b>KA 044</b>
<b>KC 149</b>	11.77 -->	1.3 Estate Car	37	07.75-04.80		
		1.3 Estate Car	37	07.75-04.80	11.76 -->	<b>KA 043</b>
<b>KC 149</b>	11.77 -->	1.3 Limousine; 1.3 Estate Car	40	10.69-08.80		
		1.3 Limousine; 1.3 Estate Car	40	10.69-08.80	--> 10.76	<b>KA 043</b>
		1.3 Limousine; 1.3 Estate Car	40	10.69-08.80	11.76 -->	<b>KA 044</b>
<b>KC 149</b>	11.77 -->	1.3 TS Limousine	44	08.72-08.80		
		1.3 TS Limousine	44	08.72-08.80	--> 10.76	<b>KA 043</b>
		1.3 TS Limousine	44	08.72-08.80	11.76 -->	<b>KA 044</b>
<b>KC 149</b>	11.77 -->	1.3 Estate Car	44	08.73-08.80		
		1.3 Estate Car	44	08.73-08.80	11.76 -->	<b>KA 043</b>
<b>KC 149</b>	10.77 -->	1.4 Limousine	49	08.76-05.79		
		1.4 Limousine	49	08.76-05.79	--> 10.76	<b>KA 043</b>
		1.4 Limousine	49	08.76-05.79	11.76 -->	<b>KA 044</b>
		1.6 Gordini Limousine	83	08.70-12.74		<b>KA 043</b>
<b>14</b>						
<b>KF 150</b>	CH. 20954 -->	1.2	42	05.76-01.80		
		1.2	42	05.76-01.80		<b>KA 044</b>
<b>KF 150</b>		1.2; 1.4	43-52	09.79-12.83		<b>KA 044</b>

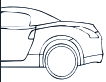
	<b>i</b>	<b>ENGINE</b>	<b>POWER (kW)</b>	<b>YEAR</b>	<b>i</b>	
Fersa KIT FRONT						Fersa KIT REAR
<b>RENAULT</b>						
<b>15</b>						
<b>KC 149</b>	10.77 -->	1.3; 1.6	44-66	03.72-10.80		
		1.3; 1.6	44-66	03.72-10.80	--> 10.76	<b>KA 043</b>
		1.3; 1.6	44-66	03.72-10.80	11.76 -->	<b>KA 044</b>
<b>16</b>						
		1.5	40	09.65-10.75		<b>KA 043</b>
		1.6 TA; 1.6 TL; 1.6 TS; 1.6 TX	40-68	09.68-08.80	--> 10.76	<b>KA 043</b>
		1.6 TA; 1.6 TL; 1.6 TS; 1.6 TX	40-68	09.68-08.80	11.76 -->	<b>KA 044</b>
<b>17</b>						
<b>KC 149</b>	11.77 -->	1.6; 1.6 Gordini	66-79	03.72-10.80		
		1.6; 1.6 Gordini	66-79	03.72-10.80		<b>KA 043</b>
<b>18</b>						
<b>KC 149</b>	--> 12.82	1.4 Limousine	47	04.78-07.86		
<b>KV 152</b>	01.83 -->	1.4 Limousine	47	04.78-07.86		
		1.4 Limousine	47	04.78-07.86		<b>KA 044</b>
<b>KC 149</b>	--> 12.82	1.4 Estate Car	47	05.79-07.86		
<b>KV 152</b>	01.83 -->	1.4 Estate Car	47	05.79-07.86		
		1.4 Estate Car	47	05.79-07.86	CH. 122601 -->	<b>KV 258</b>
<b>KC 149</b>	--> 07.82	1.4 Bus	47	05.79-07.86		
<b>KV 152</b>	08.82 -->	1.4 Bus	47	05.79-07.86		
		1.4 Bus	47	05.79-07.86	--> 12.83	<b>KA 043</b>
		1.4 Bus	47	05.79-07.86	01.84 -->	<b>KV 258</b>
<b>KV 152</b>		1.6 TURBO Limousine	80-92	10.80-07.86		
<b>KC 149</b>	--> 12.82	1.6 Estate Car	54	01.82-07.86		
<b>KV 152</b>	01.83 -->	1.6 Estate Car	54	01.82-07.86		
		1.6 Estate Car	54	01.82-07.86	CH. 118201 -->	<b>KV 258</b>
<b>KC 149</b>	--> 12.82	1.6 Limousine	54	04.82-07.86		
<b>KV 152</b>	01.83 -->	1.6 Limousine	54	04.82-07.86		
		1.6 Limousine	54	04.82-07.86		<b>KA 044</b>
<b>KC 149</b>		1.6 Limousine	58	04.78-09.82		<b>KA 044</b>
<b>KC 149</b>		1.6 Estate Car	58	05.79-09.82		
		1.6 Estate Car	58	05.79-09.82	CH. 118201 -->	<b>KV 258</b>
<b>KV 152</b>		1.6 TS Limousine	71	05.82-07.86		<b>KA 044</b>
<b>KV 152</b>		1.6 TS Estate Car	71	05.82-07.86		
		1.6 TS Estate Car	71	05.82-07.86	--> 12.83	<b>KA 043</b>
		1.6 TS Estate Car	71	05.82-07.86	01.84 -->	<b>KV 258</b>
<b>KV 152</b>		1.6 TURBO INJ. Limousine	82	09.82-07.86		
		1.6 TURBO INJ. Limousine	82	09.82-07.86	--> 12.83	<b>KA 043</b>
<b>KV 152</b>		1.6 TS	82	84-86		<b>KV 154</b>
<b>KV 152</b>		2.0 4WD Estate Car	76	05.83-12.86		
<b>KV 152</b>		2.0 GTX, TX (R1343)	77	82-87		<b>KV 154</b>
<b>KC 149</b>	--> 12.82	2.0 Estate Car	77	10.81-07.86		
<b>KV 152</b>	01.83 -->	2.0 Estate Car	77	10.81-07.86		
		2.0 Estate Car	77	10.81-07.86	CH. 9001 -->	<b>KV 258</b>
<b>KV 152</b>		2.0 Limousine	77	05.82-07.86		<b>KA 044</b>
<b>KV 152</b>		2.2i Limousine	76	06.84-07.86		<b>KV 258</b>
<b>KC 149</b>	--> 12.82	2.1 D Estate Car	49	11.80-07.86		
<b>KV 152</b>	01.83 -->	2.1 D Estate Car	49	11.80-07.86		
		2.1 D Estate Car	49	11.80-07.86	CH. 50001 -->	<b>KV 258</b>

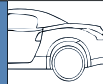
 Fersa KIT FRONT		ENGINE	POWER (kW)	YEAR		Fersa KIT REAR 
<b>RENAULT</b>						
<b>18</b>						
<b>KC 149</b>	--> 12.82	2.1 D Limousine	49	11.81-07.86		
<b>KV 152</b>	01.83 -->	2.1 D Limousine	49	11.81-07.86		
		2.1 D Limousine	49	11.81-07.86		<b>KA 044</b>
<b>KV 152</b>	07.82 --> / --> 12.84	2.1 TD Limousine	65	11.81-07.86		
		2.1 TD Limousine	65	11.81-07.86	07.82 --> / --> 12.84	<b>KA 044</b>
<b>KV 152</b>		2.1 TD (R1346)	65	83-86		<b>KV 154</b>
<b>19 I</b>						
<b>KB 048</b>		1.2 Limousine; 1.2 Hatchback; 1.4 Hatchback	40-59	01.88-12.92		
<b>KF 158</b>		1.2 Limousine; 1.2 Hatchback; 1.4 Hatchback	40-59	01.88-12.92		
		1.2 Limousine; 1.2 Hatchback; 1.4 Hatchback	40-59	01.88-12.92	ABS	<b>KB 090</b>
		1.2 Limousine; 1.2 Hatchback; 1.4 Hatchback	40-59	01.88-12.92	ABS / 01.89 -->	<b>KB 045</b>
<b>KF 158</b>		1.4 Limousine; 1.4 Hatchback	43	07.88-04.92		<b>KB 045</b>
<b>KF 158</b>		1.4 Limousine; 1.4 Hatchback	43	07.88-04.92	ABS	<b>KB 090</b>
<b>KB 048</b>		1.4 Hatchback	43	01.89-04.92		<b>KB 045</b>
<b>KF 158</b>		1.4 Hatchback	43	01.89-04.92	ABS	<b>KB 045</b>
<b>KF 158</b>		1.7 Limousine; 1.7 Hatchback	54	09.88-04.92	ABS	<b>KB 045</b>
<b>KF 158</b>		1.7 Limousine; 1.7 Hatchback	54	09.88-04.92	ABS	<b>KB 090</b>
<b>KB 048</b>		1.7 Convertible	55	07.91-04.92	ABS	<b>KB 045</b>
<b>KF 158</b>		1.7 Convertible	55	07.91-04.92	ABS	<b>KB 090</b>
<b>KF 158</b>		1.7 Limousine; 1.7 Hatchback	66	07.88-04.92	ABS	<b>KB 045</b>
<b>KF 158</b>		1.7 Limousine; 1.7 Hatchback	66	07.88-04.92	ABS	<b>KB 090</b>
<b>KB 048</b>		1.7 Convertible	70	07.91-04.92	ABS	<b>KB 045</b>
<b>KF 158</b>		1.7 Convertible	70	07.91-04.92	ABS	<b>KB 090</b>
<b>KF 158</b>		1.8 16V Limousine; 1.8 16V Hatchback; 1.8 16V Convertible	99-101	06.89-04.92	ABS	<b>KB 045</b>
		1.8 16V Limousine; 1.8 16V Hatchback; 1.8 16V Convertible	99-101	06.89-04.92	ABS	<b>KB 090</b>
<b>KF 158</b>		1.9 D Limousine; 1.9 D Hatchback	47	09.88-04.92	ABS	<b>KB 045</b>
<b>KF 158</b>		1.9 D Limousine; 1.9 D Hatchback	47	09.88-04.92	ABS	<b>KB 090</b>
<b>19 II</b>						
<b>KF 151</b>		1.2 (S530)	40-59	89-96		<b>KB 045</b>
<b>KF 151</b>		1.2 GTR,TR,TRE (B,C,L530)	40-59	89-96		<b>KB 045</b>
<b>KB 048</b>		1.2 Hatchback; 1.4 Limousine; 1.4 Hatchback	40-59	01.92-12.95	ABS	<b>KB 045</b>
<b>KF 158</b>		1.2 Hatchback; 1.4 Limousine; 1.4 Hatchback	40-59	01.92-12.95	ABS	<b>KB 090</b>
<b>KF 158</b>		1.4 Hatchback; 1.7 Limousine; 1.7 Hatchback; 1.7 Convertible	43-66	04.92-12.95	ABS	<b>KB 045</b>
<b>KF 158</b>		1.4 Hatchback; 1.7 Limousine; 1.7 Hatchback; 1.7 Convertible	43-66	04.92-12.95	ABS	<b>KB 090</b>
<b>KF 158</b>		1.8 16V Limousine; 1.8 16V Hatchback; 1.8 16V Convertible	99	04.92-06.96	ABS	<b>KB 090</b>
<b>KF 158</b>		1.8 Limousine; 1.8 Hatchback	79	05.94-12.95	ABS	<b>KB 090</b>
<b>KF 158</b>		1.8 Limousine; 1.8 Hatchback	79	05.94-12.95	ABS	<b>KB 045</b>
<b>KF 158</b>		1.8 Convertible	79	07.94-06.96	ABS	<b>KB 090</b>
<b>KF 158</b>		1.8 Limousine; 1.8 Hatchback; 1.8 Convertible	65-66	04.92-06.96	ABS	<b>KB 090</b>
<b>KF 158</b>		1.8 Limousine; 1.8 Hatchback; 1.8 Convertible	65-66	04.92-06.96	ABS	<b>KB 045</b>
<b>KF 158</b>		1.8 Limousine; 1.8 Hatchback; 1.8 Convertible	65-66	04.92-06.96		<b>KB 045</b>
<b>KB 048</b>		1.8 Convertible	66	09.93-06.96		
<b>KF 158</b>		1.8 Convertible	66	09.93-06.96	ABS	<b>KB 090</b>
<b>KF 158</b>		1.8 Convertible	66	09.93-06.96	ABS	<b>KB 045</b>
<b>KF 158</b>		1.8 Limousine; 1.8 Hatchback	81	04.92-05.94	ABS	<b>KB 090</b>
<b>KF 158</b>		1.8 Limousine; 1.8 Hatchback	81	04.92-05.94		<b>KB 045</b>
<b>KF 158</b>		1.8 Limousine; 1.8 Hatchback	81	04.92-05.94	ABS	<b>KB 045</b>
<b>KF 158</b>		1.9 D Limousine; 1.9 D Hatchback; 1.9 TD Limousine; 1.9 TD Hatchback	47-66	04.92-12.95	ABS	<b>KB 090</b>
<b>KF 158</b>		1.9 D Limousine; 1.9 D Hatchback; 1.9 TD Limousine; 1.9 TD Hatchback	47-66	04.92-12.95		<b>KB 045</b>

	<b>i</b>	ENGINE	POWER (kW)	YEAR	<b>i</b>	
Fersa KIT FRONT						Fersa KIT REAR
<b>RENAULT</b>						
<b>20</b>						
<b>KC 149</b>		1.6	66	10.75-05.77		
<b>KC 149</b>	12.80 -->	1.6	71	05.77-12.83		
<b>KV 152</b>		2.0	76	10.80-12.83		
<b>KV 152</b>		2.1 D	47	10.80-12.83		
<b>KV 152</b>		2.1 TD	63	01.82-12.83		<b>KA 043</b>
<b>21</b>						
<b>KF 158</b>		1.4 Limousine	51	06.88-10.93		<b>KV 157</b>
<b>KF 158</b>		1.4 Limousine	51	06.88-10.93		<b>KB 046</b>
<b>KF 158</b>		1.7 Estate Car	54	06.86-12.89	DRUM BRAKE	<b>KV 258</b>
<b>KF 158</b>		1.7 Limousine	54	07.86-02.94		<b>KB 046</b>
<b>KF 158</b>		1.7 Estate Car	54	05.88-06.93	DRUM BRAKE	<b>KV 258</b>
<b>KF 158</b>		1.7 Hatchback	54	09.89-10.92		<b>KB 046</b>
<b>KF 158</b>		1.7 Limousine	55	03.86-12.87		<b>KB 046</b>
<b>KF 158</b>		1.7 Estate Car	55	06.86-03.93	DRUM BRAKE	<b>KV 258</b>
<b>KF 158</b>		1.7 Limousine	64	06.87-04.89		<b>KB 046</b>
<b>KF 158</b>		1.7 Estate Car	64	06.87-04.89	DRUM BRAKE	<b>KV 258</b>
<b>KF 158</b>		1.7 Limousine	65	03.86-03.93		<b>KB 046</b>
<b>KF 158</b>		1.7 Estate Car	65	10.86-12.88	DRUM BRAKE	<b>KV 258</b>
<b>KF 158</b>		1.7 Limousine; 1.7 Hatchback	66	09.89-06.94		<b>KB 046</b>
<b>KF 158</b>		1.7 Estate Car	66	10.89-12.93	DRUM BRAKE	<b>KV 258</b>
<b>KF 158</b>		1.7 Limousine	69	03.86-02.94		<b>KB 046</b>
<b>KF 158</b>		1.7 Estate Car	69	06.86-12.89	DRUM BRAKE	<b>KV 258</b>
<b>KV 152</b>		2.0 Limousine	75-78	03.86-10.93	ABS	<b>KV 157</b>
<b>KV 152</b>		2.0 Limousine	75-78	03.86-10.93	DRUM BRAKE	<b>KV 258</b>
<b>KV 152</b>		2.0 Limousine; 2.0 Estate Car	85-88	03.86-12.93		<b>KV 157</b>
<b>KV 152</b>		2.0 Limousine; 2.0 Estate Car	85-88	03.86-12.93	DRUM BRAKE	<b>KV 258</b>
<b>KV 152</b>		2.0 Estate Car	88	03.86-12.93		<b>KV 157</b>
<b>KV 152</b>		2.0 Estate Car	88	03.86-12.93	DRUM BRAKE	<b>KV 258</b>
<b>KV 152</b>		2.0 Hatchback	88	09.89-12.93		<b>KV 157</b>
<b>KV 152</b>		2.0 Hatchback	88	09.89-12.93	DRUM BRAKE	<b>KV 258</b>
<b>KV 152</b>		2.0 Limousine; 2.0 Hatchback; 2.0 Estate Car	99	02.90-06.94		<b>KV 157</b>
<b>KV 152</b>		2.0 4x4 Hatchback; 2.0 TURBO 4x4 Limousine	99-119	02.90-10.92		
<b>KV 152</b>		2.0 TURBO Limousine	119-129	04.87-10.92		<b>KB 046</b>
<b>KV 152</b>		2.2 Limousine; 2.2 Hatchback; 2.2 Estate Car	79	06.86-06.94	ABS	<b>KV 157</b>
<b>KV 152</b>		2.2 Limousine; 2.2 Hatchback; 2.2 Estate Car	79	06.86-06.94	ABS / DRUM BRAKE	<b>KV 258</b>
<b>KV 152</b>		2.2 4x4 Limousine; 2.2 4x4 Estate Car	79	06.86-02.94		
<b>KV 152</b>		1.9 D Estate Car	47	03.86-08.94	ABS	<b>KV 157</b>
<b>KV 152</b>		1.9 D Estate Car	47	03.86-08.94	ABS / DRUM BRAKE	<b>KV 258</b>
<b>KV 152</b>		1.9 D Limousine; 1.9 D Hatchback	47	08.89-10.93		<b>KV 157</b>
<b>KV 152</b>		1.9 D Limousine; 1.9 D Hatchback	47	08.89-10.93		<b>KB 046</b>
<b>KV 152</b>		1.9 D Limousine; 1.9 D Hatchback	47	08.89-10.93	ABS / DRUM BRAKE	<b>KV 258</b>
<b>KV 152</b>		2.1 D Limousine	48	03.86-12.89		<b>KB 046</b>
<b>KV 152</b>		2.1 D 4x4 Estate Car	48	10.88-05.92		
<b>KV 152</b>		2.1 D Limousine; 2.1 D Estate Car	48-51	10.86-06.94		
<b>KV 152</b>		2.1 D Limousine; 2.1 D Estate Car	48-51	10.86-06.94	ABS	<b>KV 157</b>
<b>KV 152</b>		2.1 D Limousine; 2.1 D Estate Car	48-51	10.86-06.94	ABS / DRUM BRAKE	<b>KV 258</b>
<b>KV 152</b>		2.1 D Estate Car	51	02.92-09.95	ABS	<b>KV 157</b>
<b>KV 152</b>		2.1 D Estate Car	51	02.92-09.95	ABS / DRUM BRAKE	<b>KV 258</b>

	<b>i</b>	<b>ENGINE</b>	<b>POWER (kW)</b>	<b>YEAR</b>	<b>i</b>	
Fersa KIT FRONT						Fersa KIT REAR
<b>RENAULT</b>						
<b>21</b>						
<b>KV 152</b>		2.1 D Hatchback	51	04.92-06.94	ABS	<b>KV 157</b>
<b>KV 152</b>		2.1 D Hatchback	51	04.92-06.94		<b>KB 046</b>
<b>KV 152</b>		2.1 D Limousine	53	05.89-06.94	ABS / DRUM BRAKE	<b>KV 258</b>
<b>KV 152</b>		2.1 D Estate Car	53	08.89-12.92	ABS	<b>KV 157</b>
<b>KV 152</b>		2.1 D Estate Car	53	08.89-12.92	ABS / DRUM BRAKE	<b>KV 258</b>
<b>KV 152</b>		2.1 D Hatchback	53	09.89-12.92		<b>KV 157</b>
<b>KV 152</b>		2.1 D Hatchback	53	09.89-12.92		<b>KB 046</b>
<b>KV 152</b>		2.1 TD Limousine	65	03.86-06.94	DISC BRAKE	<b>KV 157</b>
<b>KV 152</b>		2.1 TD Limousine	65	03.86-06.94	ABS / DRUM BRAKE	<b>KV 258</b>
<b>KV 152</b>		2.1 TD Estate Car	65	10.86-11.93		<b>KV 157</b>
<b>KV 152</b>		2.1 TD Estate Car	65	10.86-11.93		<b>KV 258</b>
<b>KV 152</b>		2.1 TD Hatchback	65	09.89-06.94		<b>KB 046</b>
<b>KV 152</b>		2.0; 2.0 12V; 2.2	74-103	04.84-12.93	ABS / DISC BRAKE	<b>KV 156</b>
<b>25</b>						
<b>KV 152</b>		2.0; 2.0 12V; 2.2	74-103	04.84-12.93	ABS / DRUM BRAKE	<b>KV 258</b>
<b>KV 152</b>		2.2	79	09.86-12.92	DRUM BRAKE	<b>KV 258</b>
<b>KV 152</b>		2.2	89-91	04.84-12.89	ABS / 06.87 --> / DISC BRAKE	<b>KV 156</b>
<b>KV 152</b>		2.2	89-91	04.84-12.89	ABS / DRUM BRAKE	<b>KV 258</b>
<b>KV 152</b>		2.4 V6 TURBO; 2.5 V6 TURBO	133-151	10.84-12.92		
<b>KV 152</b>		2.7 V6 INJECTION; 2.8 V6; 2.8 V6 INJECTION	100-115	04.84-12.92		
<b>KV 152</b>		2.1 D	46-51	04.84-12.92	ABS / DISC BRAKE	<b>KV 156</b>
<b>KV 152</b>		2.1 D	46-51	04.84-12.92	ABS / DRUM BRAKE	<b>KV 258</b>
<b>KV 152</b>		2.1 TD	63	04.84-12.92	ABS / DISC BRAKE	<b>KV 156</b>
<b>KV 152</b>		2.1 TD	63	04.84-12.92	ABS / DRUM BRAKE	<b>KV 258</b>
<b>KV 152</b>		2.1 TD	63	02.82-03.86	01.84 -->	<b>KV 258</b>
<b>KF 153</b>		2.1 TD (R1270)	63	84		<b>KV 154</b>
<b>CHAMADE</b>						
<b>KF 151</b>		1.2, GTR, TR, TRE (B/C/L530)	40-59	89-96		<b>KB 045</b>
<b>KF 151</b>		1.4 GTR, TR (B/C/L53P, 531, 532)	40-59	89-96		<b>KB 045</b>
<b>CLIO I</b>						
<b>KF 158</b>	<b>ABS</b>	1.1 Hatchback; 1.1 Bus; 1.2 Hatchback; 1.2 Bus; 1.2 (B/C/S572) Hatchback; 1.4 Hatchback; 1.4 (B57J, C57J) Hatchback; 1.7 Hatchback; 1.8 Hatchback; 1.8i Hatchback; Williams Hatchback	34-108	05.90-09.98	<b>ABS</b>	<b>KB 045</b>
<b>KB 048</b>	<b>ABS</b>	1.1 Hatchback; 1.1 Bus; 1.2 Hatchback; 1.2 Bus; 1.2 (B/C/S572) Hatchback; 1.4 Hatchback; 1.4 (B57J, C57J) Hatchback; 1.7 Hatchback; 1.8 Hatchback; 1.8i Hatchback; Williams Hatchback	34-108	05.90-09.98	<b>ABS</b>	<b>KB 045</b>
		1.1 Hatchback; 1.1 Bus; 1.2 Hatchback; 1.2 Bus; 1.2 (B/C/S572) Hatchback; 1.4 Hatchback; 1.4 (B57J, C57J) Hatchback; 1.7 Hatchback; 1.8 Hatchback; 1.8i Hatchback; Williams Hatchback	34-108	05.90-09.98	ABS	<b>KB 090</b>
<b>KF 158</b>	<b>ABS</b>	1.9 D Hatchback; 1.9 D Bus; 1.9 RND Bus	40-48	01.91-09.98	<b>ABS</b>	<b>KB 045</b>
<b>KB 048</b>	<b>ABS</b>	1.9 D Hatchback; 1.9 D Bus; 1.9 RND Bus	40-48	01.91-09.98	<b>ABS</b>	<b>KB 045</b>
		1.9 D Hatchback; 1.9 D Bus; 1.9 RND Bus	40-48	01.91-09.98	ABS	<b>KB 090</b>
<b>CLIO II</b>						
<b>KV 152</b>	DRUM BRAKE	1.1 Bus; 1.2 Hatchback	43	98-		<b>KB 193</b>
<b>KB 048</b>		1.1 Bus; 1.2 Hatchback	43	09.98-	ABS	<b>KB 090</b>
<b>KB 048</b>		1.1 Bus; 1.2 Hatchback	43	09.98-	<b>ABS</b>	<b>KB 045</b>
<b>KB 048</b>		1.1 Bus; 1.2 Hatchback	43	09.98-		
		1.1 Bus; 1.2 Hatchback	43	09.98-	<b>ABS</b>	<b>KB 090</b>
		1.1 Bus; 1.2 Hatchback	43	09.98-	ABS	<b>KB 045</b>

	<b>i</b>	ENGINE	POWER (kW)	YEAR	<b>i</b>	
Fersa KIT FRONT						Fersa KIT REAR
<b>RENAULT</b>						
<b>CLIO II</b>						
<b>KF 158</b>	<b>ABS</b>	1.2 16V Hatchback; 1.4 Hatchback; 1.4 16V Hatchback; 1.6 Hatchback	55-72	09.98-	<b>ABS</b>	<b>KB 045</b>
		1.2 16V Hatchback; 1.4 Hatchback; 1.4 16V Hatchback; 1.6 Hatchback	55-72	09.98-	<b>ABS</b>	<b>KB 090</b>
<b>KB 048</b>		1.6	79	11.03-	<b>ABS</b>	<b>KB 045</b>
		1.6	79	11.03-	<b>ABS</b>	<b>KB 090</b>
<b>KF 158</b>	<b>ABS</b>	1.6 16V Hatchback; 2.0 16V Sport Hatchback	79-132	09.98-	<b>ABS</b>	<b>KB 045</b>
		1.6 16V Hatchback; 2.0 16V Sport Hatchback	79-132	09.98-	<b>ABS</b>	<b>KB 090</b>
		1.6 16V Hatchback; 2.0 16V Sport Hatchback	79-132	09.98-	<b>ABS</b>	<b>KB 045</b>
<b>KB 048</b>		1.5 dCi Bus	48	06.01-		<b>KB 045</b>
		1.5 dCi Bus	48	06.01-	<b>ABS</b>	<b>KB 090</b>
<b>KF 158</b>	<b>ABS</b>	1.5 dCi Hatchback; 1.9 D Hatchback	47-74	09.98-	<b>ABS</b>	<b>KB 045</b>
		1.5 dCi Hatchback; 1.9 D Hatchback	47-74	09.98-	<b>ABS</b>	<b>KB 090</b>
<b>KB 048</b>		1.9 D Bus	47	09.98-	<b>ABS</b>	<b>KB 045</b>
		1.9 D Bus	47	09.98-	<b>ABS</b>	<b>KB 090</b>
		1.9 D Bus	47	09.98-	<b>ABS</b>	<b>KB 045</b>
<b>KF 158</b>	<b>ABS</b>	1.9 dTi Hatchback	59	02.00-05.05	<b>ABS</b>	<b>KB 045</b>
		1.9 dTi Hatchback	59	02.00-05.05	<b>ABS</b>	<b>KB 090</b>
<b>CLIO III</b>						
<b>KF 351</b>		1.2; 1.2 16V; 1.4 16V; 1.6 16V; 2.0 16V; 2.0 16V Sport	43-145	06.05-	<b>DISC BRAKE</b>	<b>KB 350</b>
<b>KF 351</b>		1.2; 1.2 16V; 1.4 16V; 1.6 16V; 2.0 16V; 2.0 16V Sport	43-145	06.05-	<b>DRUM BRAKE</b>	<b>KB 045</b>
<b>KF 351</b>		1.5 dCi	47-78	06.05-	<b>DISC BRAKE</b>	<b>KB 350</b>
<b>KF 351</b>		1.5 dCi	47-78	06.05-		<b>KB 045</b>
<b>ESPACE I</b>						
<b>KV 152</b>		2.0	74-80	07.84-12.90	<b>DRUM BRAKE</b>	<b>KV 258</b>
<b>KV 152</b>		2.0i Quadra	87	03.88-12.92		<b>KF 158</b>
<b>KV 152</b>		2.0i	87	01.89-12.90	<b>DISC BRAKE</b>	<b>KV 156</b>
<b>KV 152</b>		2.0i	87	01.89-12.90	<b>DRUM BRAKE</b>	<b>KV 156</b>
<b>KV 152</b>		2.0i	87	01.89-12.90	<b>DRUM BRAKE</b>	<b>KV 258</b>
<b>KV 152</b>		2.2	79	07.86-12.90	<b>DISC BRAKE</b>	<b>KV 156</b>
<b>KV 152</b>		2.2	79	07.86-12.90	<b>DRUM BRAKE</b>	<b>KV 258</b>
<b>KV 152</b>		2.2 Quadra	79	01.88-12.90		<b>KF 158</b>
<b>KV 152</b>		2.1 TD	65	10.84-12.90	<b>DISC BRAKE</b>	<b>KV 156</b>
<b>KV 152</b>		2.1 TD	65	10.84-12.90	<b>DRUM BRAKE</b>	<b>KV 258</b>
<b>ESPACE II</b>						
<b>KV 152</b>		2.0; 2.2	76-79	01.91-10.96	<b>DISC BRAKE</b>	<b>KV 156</b>
<b>KV 152</b>		2.2 4x4	79	03.91-12.96		
<b>KV 152</b>		2.8 V6	110	01.91-10.96		
<b>KV 152</b>		2.1 TD	65	01.91-10.96	<b>DISC BRAKE</b>	<b>KV 156</b>
<b>KV 152</b>		2.1 TD	66	11.94-10.96	<b>DISC BRAKE</b>	<b>KV 156</b>
<b>ESPACE III</b>						
<b>KF 312</b>		2.0; 2.0 16V; 3.0; 3.0 V6	84-140	11.96-10.02		
<b>KF 312</b>		1.9 dTi; 2.2 12V TD; 2.2 dCi	72-95	11.96-10.02		
<b>ESPACE IV</b>						
<b>KF 334</b>		2.0; 2.0 TURBO; 3.5 V6	100-177	11.02-		
<b>KF 334</b>		1.9 DCi Expression	85	04.03-02.05		
<b>KF 334</b>		1.9 dCi; 2.0 dCi; 2.2 dCi; 3.0 dCi	88-133	11.02-		
<b>EXPRESS</b>						
<b>KB 048</b>		1.0	27	02.86-05.92		

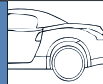
	<b>i</b>	<b>ENGINE</b>	<b>POWER (kW)</b>	<b>YEAR</b>	<b>i</b>	
Fersa KIT FRONT						Fersa KIT REAR
<b>RENAULT</b>						
<b>EXPRESS</b>						
KF 158		1.0	27	02.86-05.92		KB 046
KF 158		1.0	27	02.86-05.92		KB 047
KB 048		1.1	33	07.85-04.95		
KF 158		1.1	33	07.85-04.95		
		1.1	33	07.85-04.95		KB 046
		1.1	33	07.85-04.95		KB 047
KB 048		1.1	33	06.87-09.91		
KF 158		1.1	33	06.87-09.91		
		1.1	33	06.87-09.91		KB 046
		1.1	33	06.87-09.91		KB 047
KB 048		1.2	40	09.91-03.98		
KF 158		1.2	40	09.91-03.98		
		1.2	40	09.91-03.98		KV 258
KB 048		1.4	43-58	07.85-03.98		
KF 158		1.4	43-58	07.85-03.98		
		1.4	43-58	07.85-03.98		KV 258
		1.4	43-58	07.85-03.98		KB 047
KB 048		1.6 D	40	03.86-08.98		
KF 158		1.6 D	40	03.86-08.98		
		1.6 D	40	03.86-08.98		KB 046
		1.6 D	40	03.86-08.98		KB 047
KB 048		1.9 D	40-47	09.91-03.98		
KF 158		1.9 D	40-47	09.91-03.98		
		1.9 D	40-47	09.91-03.98		KV 258
<b>EXTRA</b>						
KF 151		Extra 1.2 (F40F)	40	85-90		KB 046
KF 151		Extra 1.4 (F402,407,40A/U)	40	85-		KB 046
<b>FUEGO</b>						
KV 152		1.4 TL/GTL	47	02.80-10.85		KA 044
KV 152		1.6 TURBO INJECTION	97	08.83-10.85		
KV 152		1.6 TS/GTS	71	10.80-10.85	06.84 -->	KV 258
KV 152		2.0 TX,GTX	81	10.80-10.85	06.84 -->	KV 258
<b>KANGOO</b>						
KF 158	ABS	1.2; 1.2 16V; 1.4; 1.6; 1.6 16V; 1.6 16V bivalent	43-70	03.98-	ABS	KB 047
KF 158	ABS	1.5 dCi; 1.9 dci; 1.9 dTi; 1.9 RXED; D 55 1.9; D 65 1.9	40-62	03.98-	ABS	KB 047
<b>LAGUNA (B56_,K56_)</b>						
KF 195		1.6 16V Hatchback	66	93-06.99		
KF 277		1.6 16V Hatchback	79	11.97-03.01		KB 047
KF 277		1.6 16V Estate Car	79	11.97-03.01		
KF 277		1.8 Hatchback	66	08.95-03.01		
KF 158	ABS	1.8 Hatchback	66	08.95-03.01	ABS	KB 047
		1.8 Hatchback	66	08.95-03.01		KV 244
KF 155	--> 01.97	1.8 Estate Car	66	09.95-03.01		
KF 277		1.8 Estate Car	66	09.95-03.01		
KF 155		1.8 Estate Car	66	09.95-03.01		
KF 277		1.8 16V Hatchback	88	04.98-03.01	--> 09.99	KB 047
KF 277		1.8 16V Estate Car	88	04.98-03.01		
KF 155		1.8 Hatchback	66	11.93-03.01		

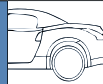

	<b>i</b>	<b>ENGINE</b>	<b>POWER (kW)</b>	<b>YEAR</b>	<b>i</b>	
Fersa KIT FRONT						Fersa KIT REAR
<b>RENAULT</b>						
<b>LAGUNA (B56_,K56_)</b>						
		1.8 Hatchback	66	11.93-03.01	ABS	<b>KV 244</b>
<b>KF 158</b>		1.8 Hatchback	66	11.93-03.01	<del>ABS</del>	<b>KB 047</b>
<b>KF 155</b>		1.8 Hatchback	69	08.95-03.01		
<b>KF 155</b>		1.8 Hatchback	69	08.95-03.01		
<b>KF 158</b>		1.8 Hatchback	69	08.95-03.01		<b>KB 047</b>
<b>KF 155</b>		1.8 Estate Car	69	09.95-03.01		
<b>KF 155</b>	--> 01.97	2.0 16V Hatchback	102	06.95-03.01		
<b>KF 277</b>	02.97 -->	2.0 16V Hatchback	102	06.95-03.01		
<b>KF 155</b>		2.0 16V Hatchback	102	06.95-03.01		
		2.0 16V Hatchback	102	06.95-03.01	--> 12.97	<b>KV 243</b>
<b>KF 155</b>	--> 01.97	2.0 16V Estate Car	102	09.95-03.01		
<b>KF 277</b>	02.97 -->	2.0 16V Estate Car	102	09.95-03.01		
<b>KF 155</b>		2.0 16V Estate Car	102	09.95-03.01		
<b>KF 155</b>	--> 01.97	2.0 Hatchback	70	11.93-03.01		
<b>KF 277</b>	02.97 -->	2.0 Hatchback	70	11.93-03.01		
		2.0 Hatchback	70	11.93-03.01	--> 12.97	<b>KV 243</b>
<b>KF 277</b>		2.0 Hatchback	80	03.99-03.01		
<b>KF 155</b>	--> 01.97	2.0 Hatchback	83	11.93-03.01		
<b>KF 277</b>	02.97 -->	2.0 Hatchback	83	11.93-03.01		
<b>KF 155</b>		2.0 Hatchback	83	11.93-03.01	--> 05.95	<b>KV 244</b>
<b>KF 155</b>		2.0 Hatchback	83	11.93-03.01	06.95 -->	<b>KB 047</b>
<b>KF 155</b>		2.0 Estate Car	83	09.95-03.01		
<b>KF 277</b>		2.0 16V Hatchback	103	09.99-03.01		
<b>KF 277</b>		2.9 24V Hatchback	140	03.97-03.01		
<b>KF 277</b>		2.9 24V Estate Car	140	03.97-03.01		
<b>KF 155</b>	--> 01.97	3.0 Hatchback	123	11.93-03.01		
<b>KF 277</b>	02.97 -->	3.0 Hatchback	123	11.93-03.01		
<b>KF 155</b>		3.0 Hatchback	123	11.93-03.01		
		3.0 Hatchback	123	11.93-03.01	--> 12.96	<b>KV 243</b>
<b>KF 155</b>	01.97,	3.0 Estate Car	123	02.96-03.01		
<b>KF 277</b>	02.97 -->	3.0 Estate Car	123	02.96-03.01		
<b>KF 155</b>		3.0 Estate Car	123	02.96-03.01		
<b>KF 277</b>		1.9 dTi Hatchback	72	10.97-03.01	<del>ABS</del>	<b>KB 047</b>
<b>KF 277</b>		1.9 dTi Estate Car	72	10.97-03.01		
<b>KF 277</b>		1.9 dCi Hatchback	79	09.99-03.01		
<b>KF 277</b>		1.9 dCi Estate Car	79	09.99-03.01		
<b>KF 155</b>		2.2 D Hatchback	61	11.93-03.01	ABS / --> 05.95	<b>KV 244</b>
<b>KF 155</b>		2.2 D Hatchback	61	11.93-03.01	<del>ABS</del>	
<b>KF 155</b>		2.2 D Hatchback	61	11.93-03.01	<del>ABS</del> / 06.95 -->	<b>KB 047</b>
<b>KF 155</b>		2.2 D Estate Car	61	09.95-03.01		
<b>KF 155</b>	--> 01.97	2.2 TD Hatchback	83	03.96-03.01	--> 01.97	<b>KV 243</b>
<b>KF 277</b>	02.97 -->	2.2 TD Hatchback	83	03.96-03.01		
<b>KF 155</b>	--> 01.97	2.2 TD Estate Car	83	03.96-03.01		
<b>KF 277</b>	02.97 -->	2.2 TD Estate Car	83	03.96-03.01		
<b>MASTER I</b>						
<b>KA 255</b>	--> 10.97	28-35 2.0 Bus; 28-35 2.0 Bus	58	10.86-07.98		
<b>KB 293</b>	11.97 -->	28-35 2.0 Bus; 28-35 2.0 Bus	58	10.86-07.98		
<b>KB 293</b>	11.97 -->	28-35 2.0 Platform	58	10.86-07.98		

	<b>i</b>	<b>ENGINE</b>	<b>POWER (kW)</b>	<b>YEAR</b>	<b>i</b>	
Fersa KIT FRONT						Fersa KIT REAR
<b>RENAULT</b>						
<b>MASTER I</b>						
<b>KA 255</b>	01.81 -->	28-35 2.0 Bus; 28-35 2.0 Bus; 30 2,2 Bus; 30 2,2 Bus	59-67	08.80-07.98		
<b>KA 255</b>	01.81 -->	28-35 2.1 D Bus; 28-35 2.1 D Bus; 28-35 2.4 D Bus; 28-35 2.4 D Bus	44-52	08.80-07.98		
<b>KB 293</b>	11.97 -->	28-35 2.5 D Platform	52	09.80-07.98		
<b>KA 255</b>	--> 10.97	28-35 2.5 D Bus; 28-35 2.5 D Bus; 28-35 2.5 TD Bus; 28-35 2.5 TD Bus; 35 2,5 TD Bus; 35 2,5 TD Bus	55-72	08.89-07.98		
<b>KB 293</b>	11.97 -->	28-35 2.5 D Bus; 28-35 2.5 D Bus; 28-35 2.5 TD Bus; 28-35 2.5 TD Bus; 35 2,5 TD Bus; 35 2,5 TD Bus	55-72	08.89-07.98		
		28-35 2.5 D Bus; 28-35 2.5 D Bus; 28-35 2.5 TD Bus; 28-35 2.5 TD Bus; 35 2,5 TD Bus; 35 2,5 TD Bus	55-72	08.89-07.98	11.97 -->	<b>KB 344</b>
<b>MASTER II</b>						
<b>KB 278</b>		1.9 dCi; 1.9 dTi; 2.2 dCi; 2.5 dCi	59-84	09.00-		
<b>KB 293</b>		2.5 D; 2.8 dT; 2.8 dTi	59-84	07.98-10.01		
<b>KB 278</b>		2.5 D; 2.8 dT; 2.8 dTi	59-84	07.98-10.01		<b>KB 344</b>
<b>MEGANE I</b>						
<b>KB 278</b>		1.4 Limousine; 1.4 ECO Hatchback	52-55	01.96-	ABS	<b>KB 090</b>
<b>KB 278</b>		1.4 Limousine; 1.4 ECO Hatchback	52-55	01.96-		<b>KB 045</b>
<b>KB 278</b>		1.4 e Estate Car	55	03.99-	DRUM BRAKE	<b>KV 246</b>
<b>KB 278</b>		1.4 16V Limousine; 1.4 16V Hatchback; 1.4i Hatchback	55-70	01.96-	ABS	<b>KB 090</b>
<b>KB 278</b>		1.4 16V Limousine; 1.4 16V Hatchback; 1.4i Hatchback	55-70	01.96-		<b>KB 045</b>
<b>KB 278</b>		1.4 16V Estate Car	70	03.99-	DRUM BRAKE	<b>KV 246</b>
<b>KB 278</b>		1.4 16V Coupe; 1.4 16V Convertible; 1.6 e Limousine; 1.6 e Hatchback; 1.6i Limousine; 1.6i Hatchback	55-70	01.96-	ABS	<b>KB 090</b>
<b>KB 278</b>		1.4 16V Coupe; 1.4 16V Convertible; 1.6 e Limousine; 1.6 e Hatchback; 1.6i Limousine; 1.6i Hatchback	55-70	01.96-		<b>KB 045</b>
<b>KB 278</b>		1.6 e Estate Car	66	03.99-	DRUM BRAKE	<b>KV 246</b>
<b>KB 278</b>		1.6 16V Limousine; 1.6 16V Hatchback; 1.6 e Coupe; 1.6 e Convertible	66-79	03.96-	ABS	<b>KB 090</b>
<b>KB 278</b>		1.6 16V Limousine; 1.6 16V Hatchback; 1.6 e Coupe; 1.6 e Convertible	66-79	03.96-		<b>KB 045</b>
<b>KB 278</b>		1.6 16V Estate Car	79	03.99-	DRUM BRAKE	<b>KV 246</b>
<b>KB 278</b>		1.6 16V Coupe; 1.6 16V Convertible; 1.8 16V Limousine; 1.8 16V Hatchback	79-85	03.99-	ABS	<b>KB 090</b>
<b>KB 278</b>		1.6 16V Coupe; 1.6 16V Convertible; 1.8 16V Limousine; 1.8 16V Hatchback	79-85	03.99-		<b>KB 045</b>
<b>KB 278</b>		1.8 16V Estate Car	85	01.01-		
<b>KB 278</b>		1.8 16V Estate Car	85	01.01-	DRUM BRAKE	<b>KV 246</b>
<b>KB 278</b>		2.0 Convertible; 2.0 16V Coupe; 2.0 16V IDE Coupe; 2.0 16V IDE Convertible; 2.0i Limousine; 2.0i Hatchback; 2.0i Coupe; 2.0i Convertible	80-103	01.96-	ABS	<b>KB 090</b>
<b>KB 278</b>		2.0 Convertible; 2.0 16V Coupe; 2.0 16V IDE Coupe; 2.0 16V IDE Convertible; 2.0i Limousine; 2.0i Hatchback; 2.0i Coupe; 2.0i Convertible	80-103	01.96-		<b>KB 045</b>
<b>KF 155</b>	--> 10.98	2.0 16V Hatchback; 2.0 16V Coupe	108	03.96-		
<b>KF 158</b>	11.98 -->	2.0 16V Hatchback; 2.0 16V Coupe	108	03.96-		
<b>KF 158</b>		2.0 16V Hatchback; 2.0 16V Coupe	108	03.96-	ABS	<b>KB 090</b>
<b>KF 158</b>		2.0 16V Hatchback; 2.0 16V Coupe	108	03.96-		<b>KB 045</b>
<b>KF 158</b>	<b>ABS</b>	2.0 16V Convertible; 2.0 RT	108-112	10.96-11.99	ABS	<b>KB 090</b>
<b>KF 158</b>	<b>ABS</b>	2.0 16V Convertible; 2.0 RT	108-112	10.96-11.99		<b>KB 045</b>
<b>KF 158</b>		2.0 16V Convertible; 2.0 RT	108-112	10.96-11.99	ABS	<b>KB 090</b>
<b>KF 158</b>		2.0 16V Convertible; 2.0 RT	108-112	10.96-11.99		<b>KB 045</b>
<b>KF 158</b>	<b>ABS</b>	1.9 D Limousine; 1.9 D Eco Hatchback	47	01.96-	ABS	<b>KB 090</b>
<b>KF 158</b>	<b>ABS</b>	1.9 D Limousine; 1.9 D Eco Hatchback	47	01.96-		<b>KB 045</b>

	<b>i</b>	<b>ENGINE</b>	<b>POWER (kW)</b>	<b>YEAR</b>	<b>i</b>	
Fersa KIT FRONT						Fersa KIT REAR
<b>RENAULT</b>						
<b>MEGANE I</b>						
KF 158	ABS	1.9 D Estate Car	47	04.99-	DRUM BRAKE	KV 246
KF 158	ABS	1.9 dTi Limousine; 1.9 dTi Hatchback	59	02.01-	ABS	KB 090
KF 158	ABS	1.9 dTi Limousine; 1.9 dTi Hatchback	59	02.01-		KB 045
KF 158	ABS	1.9 dTi Estate Car	59	02.01-	DRUM BRAKE	KV 246
KF 158	ABS	1.9 TD Hatchback	66	01.96-	ABS	KB 090
KF 158	ABS	1.9 TD Hatchback	66	01.96-		KB 045
KF 158	ABS	1.9 TD Limousine	66	09.96-	ABS	KB 090
KF 158	ABS	1.9 TD Limousine	66	09.96-		KB 045
KF 158	ABS	1.9 TDi Limousine	69	09.96-	ABS	KB 090
KF 158	ABS	1.9 TDi Limousine	69	09.96-		KB 045
KF 158	ABS	1.9 TDi Hatchback	69	09.96-	ABS	KB 090
KF 158	ABS	1.9 TDi Hatchback	69	09.96-		KB 045
KF 158	ABS	1.9 dTi Limousine	72	03.97-02.01	ABS	KB 090
KF 158	ABS	1.9 dTi Limousine	72	03.97-02.01		KB 045
KF 158	ABS	1.9 dTi Hatchback	72	03.97-02.01	ABS	KB 090
KF 158	ABS	1.9 dTi Hatchback	72	03.97-02.01		KB 045
KF 158	ABS	1.9 dTi Estate Car	72	03.99-02.01	DRUM BRAKE	KV 246
KF 195		2.0 (BAOH)	72	95-10.98		
KF 158	ABS	1.9 dCi Limousine; 1.9 dCi Hatchback; 1.9 dTi Coupe	72-75	03.97-	ABS	KB 090
KF 158	ABS	1.9 dCi Limousine; 1.9 dCi Hatchback; 1.9 dTi Coupe	72-75	03.97-		KB 045
KF 158	ABS	1.9 dCi Estate Car	75	02.01-	DRUM BRAKE	KV 246
KF 158	ABS	1.9 dCi Coupe	75	02.01-	ABS	KB 090
KF 158	ABS	1.9 dCi Coupe	75	02.01-		KB 045
<b>MEGANE II</b>						
KF 351		1.4 16V Limousine	60	10.03-		KB 350
KF 351		1.4 Estate Car	72	08.03-		
KF 351		1.4 16V (BMOB, CMOB) Limousine; 1.6 Limousine; 1.6 Coupe; 1.6 16V Limousine	72-82	11.02-		KB 350
KF 351		1.6 Flex-Fuel Limousine	77	01.07-		KB 350
KF 351		1.6 16V Coupe	82	01.07-		KB 350
KF 351		1.6 Coupe; 1.6 16V Limousine	83	11.02-		KB 350
KF 351		1.6 Estate Car	83	08.03-		
KF 351		2.0 Estate Car	99	08.03-		
KF 351		2.0 Coupe; 2.0 16V Limousine; 2.0 16V Turbo Limousine; 2.0 16V Turbo Coupe; 2.0 Renault Sport Limousine	99-165	11.02-		KB 350
KF 351		1.5 dCi Estate Car	60	08.03-		
KF 351		1.5 dCi Limousine; 1.5 dCi (BMOF, CMOF) Limousine	60-63	11.02-		KB 350
KF 351		1.5 dCi Estate Car	63	05.05-		
KF 351		1.5 dCi Limousine; 1.5 dCi Coupe	63-74	10.03-		KB 350
KF 351		1.5 dCi Estate Car	74	02.04-		
KF 351		1.5 dCi Limousine	76	01.07-		KB 350
KF 351		1.5 dCi Estate Car	76	01.07-		
KF 351		1.5 dCi Limousine; 1.5 dCi Coupe	76-78	05.05-		KB 350
KF 351		1.5 dCi Estate Car	78	05.05-		
KF 351		1.5 dCi Coupe; 1.9 dCi Limousine	68-78	03.04-		KB 350
KF 351		1.9 dCi Estate Car	68	03.04-		
KF 351		1.9 dCi Limousine	81	05.05-		KB 350
KF 351		1.9 dCi Estate Car	81	05.05-		

	<b>i</b>	ENGINE	POWER (kW)	YEAR	<b>i</b>	
Fersa KIT FRONT						Fersa KIT REAR
<b>RENAULT</b>						
<b>MEGANE II</b>						
<b>KF 351</b>		1.9 dCi Coupe	81	05.05-		<b>KB 350</b>
<b>KF 351</b>		1.9 dCi Limousine	88	11.02-		<b>KB 350</b>
<b>KF 351</b>		1.9 dCi Estate Car	88	08.03-		
<b>KF 351</b>		1.9 dCi Limousine; 1.9 dCi Coupe	88-96	09.03-		<b>KB 350</b>
<b>KF 351</b>		1.9 dCi Estate Car	96	05.05-		
<b>KF 351</b>		1.9 dCi Coupe	96	05.05-		<b>KB 350</b>
<b>KF 351</b>		2.0 dCi Limousine; 2.0 dCi Estate Car	110	09.05-		
<b>KF 351</b>		2.0 dCi Limousine	127	01.07-		<b>KB 350</b>
<b>MEGANE SCENIC</b>						
<b>KF 158</b>		1.4i; 1.6i	55	01.97-09.99		
		1.4i; 1.6i	55	01.97-09.99	DRUM BRAKE	<b>KV 246</b>
<b>KF 155</b>	--> 06.98 / [A.T]	1.6 e	66	01.97-09.99	DRUM BRAKE	<b>KV 246</b>
<b>KF 158</b>	07.98 --> / [A.T]	1.6 e	66	01.97-09.99	DRUM BRAKE	<b>KV 246</b>
<b>KF 158</b>		1.6 e	66	01.97-09.99	DRUM BRAKE	<b>KV 246</b>
<b>KF 158</b>		2.0i	80	01.99-09.99	DRUM BRAKE	<b>KV 246</b>
<b>KF 155</b>	--> 06.98	2.0i	84	01.97-09.99	DRUM BRAKE	<b>KV 246</b>
<b>KF 158</b>	07.98 -->	2.0i	84	01.97-09.99	DRUM BRAKE	<b>KV 246</b>
<b>KF 155</b>	--> 06.98	1.9 D	47	03.97-09.99	DRUM BRAKE	<b>KV 246</b>
<b>KF 158</b>	07.98 -->	1.9 D	47	03.97-09.99	DRUM BRAKE	<b>KV 246</b>
<b>KF 155</b>		1.9 dT	66	01.97-09.99	DRUM BRAKE	<b>KV 246</b>
<b>KF 155</b>	--> 06.98	1.9 dTi	72	04.97-09.99	DRUM BRAKE	<b>KV 246</b>
<b>KF 158</b>	07.98 -->	1.9 dTi	72	04.97-09.99	DRUM BRAKE	<b>KV 246</b>
<b>MODUS</b>						
<b>KF 351</b>		1.2; 1.4; 1.6	48-82	12.04-		<b>KB 045</b>
		1.2 (FOPC, FPOK, JPOT, JPOK, JPOS, JPOT)	48-82	12.04-05.05		<b>KB 193</b>
<b>KF 351</b>		1.5; 1.5 dCi	50-78	12.04-		<b>KB 045</b>
		1.4 (JP01, JPOJ)	50-78	12.04-05.05		<b>KB 193</b>
<b>RAPID</b>						
<b>KB 048</b>		1.0	27	02.86-05.92		<b>KB 046</b>
<b>KF 158</b>		1.0	27	02.86-05.92		<b>KB 046</b>
<b>KB 048</b>		1.0	27	02.86-05.92		<b>KB 047</b>
<b>KF 158</b>		1.0	27	02.86-05.92		<b>KB 047</b>
<b>KF 151</b>		1.1 (F401)	27	85-90		<b>KB 046</b>
<b>KB 048</b>		1.1	33	07.85-04.95		<b>KB 046</b>
<b>KF 158</b>		1.1	33	07.85-04.95		<b>KB 046</b>
<b>KB 048</b>		1.1	33	07.85-04.95		<b>KB 047</b>
<b>KF 158</b>		1.1	33	07.85-04.95		<b>KB 047</b>
		1.1	33	07.85-04.95		<b>KB 046</b>
<b>KB 048</b>		1.1	33	06.87-09.91		<b>KB 046</b>
<b>KF 158</b>		1.1	33	06.87-09.91		<b>KB 046</b>
<b>KB 048</b>		1.1	33	06.87-09.91		<b>KB 047</b>
<b>KF 158</b>		1.1	33	06.87-09.91		<b>KB 047</b>
		1.1	33	06.87-09.91		<b>KB 047</b>
<b>KB 048</b>		1.2	40	09.91-03.98		<b>KV 258</b>
<b>KF 158</b>		1.2	40	09.91-03.98		<b>KV 258</b>
<b>KF 151</b>		1.4 (F402)	27	85-89		<b>KB 046</b>
<b>KB 048</b>		1.4	43-58	07.85-03.98	ABS	<b>KV 258</b>
<b>KF 158</b>		1.4	43-58	07.85-03.98	ABS	<b>KV 258</b>

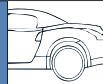

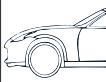
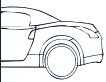
	<b>i</b>	ENGINE	POWER (kW)	YEAR	<b>i</b>	
Fersa KIT FRONT						Fersa KIT REAR
<b>RENAULT</b>						
<b>RAPID</b>						
KB 048		1.4	43-58	07.85-03.98	ABS	KB 047
KF 158		1.4	43-58	07.85-03.98	ABS	KB 047
KB 048		1.6 D	40	03.86-08.98		KB 046
KF 158		1.6 D	40	03.86-08.98		KB 046
KB 048		1.6 D	40	03.86-08.98		KB 047
KF 158		1.6 D	40	03.86-08.98		KB 047
KB 048		1.9 D	40-47	09.91-03.98		
KF 158		1.9 D	40-47	09.91-03.98		KV 258
<b>SAFRANE I</b>						
KF 195		B54B	101	92-09.96		
KF 195		B54J	101	92-09.96		
KF 195		B545	101	92-		
KF 195		B542 4 holes	101	92-		
KF 155		2.0; 2.0 12V	77-97	04.92-07.96		
KF 155		2.2	79	04.92-07.96		KV 258
KF 155	--> 02.95	2.2	101	04.92-07.96		
KF 155		3.0 V6	123	12.92-07.96		
KF 155		3.0 V6 4x4	123	12.92-07.96		
KF 155		2.1 TD	65	11.93-07.96		KV 258
KF 155		2.5 TD	83	12.92-07.96		
<b>SAFRANE II</b>						
KF 155	--> 03.97	2.0 16V; 2.5 20V	100-121	07.96-12.00		
KF 155		2.9 24V	140	03.99-12.00		
		3.0 V6	123	07.96-12.00		KB 045
KF 155	--> 03.97	2.2 TD	83	07.96-12.00		
<b>SCÉNIC</b>						
KF 158		1.4 16V; 1.6; 1.6 16V; 1.8 16V; 2.0; 2.0 16V IDE	70-103	09.99-08.03	ABS / DRUM BRAKE	KV 246
KF 158		1.9 dCi; 1.9 dTi	59-75	09.99-08.03	ABS / DRUM BRAKE	KV 246
<b>SUPER 5</b>						
KB 048		1.0; 1.1; 1.2; 1.4	30-52	10.84-12.96		KB 045
KB 048		1.4 TURBO	88-118	01.85-05.91		KB 090
		1.4 TURBO	88-118	01.85-05.91		KB 090
KB 048		1.7; 1.7i	54-69	10.86-03.95		KB 045
		1.7; 1.7i	54-69	10.86-03.95		KB 045
KB 048		1.7; 1.7i	54-69	10.86-03.95		
KB 048		1.6 D	40	08.85-12.96		KB 045
		1.6 D	40	08.85-12.96		KB 045
KB 048		1.6 D	40	08.85-12.96		
<b>TRAFIC (TA)</b>						
KF 153		TRAFIC (TA)	48	84-85		KA 091
KF 153		TRAFIC (TA)	48	85-86		KA 049
<b>TRAFIC (TB)</b>						
KF 153		TRAFIC (TB)	48	87-02.89		KA 049
<b>TRAFIC (T1)</b>						
KF 153		TRAFIC (T1)	48	84-86		KA 091
<b>TRAFIC (EL)</b>						
KF 340	ABS / --> 11.02	2.0 (ELOA)	88	03.01-		KB 339
KF 315	ABS / --> 11.02	2.0 (ELOA)	88	03.01-		KB 339
KF 334	11.02 -->	2.0 (ELOA)	88	03.01-		KB 339

 Fersa KIT FRONT	<b>i</b>	ENGINE	POWER (kW)	YEAR	<b>i</b>	Fersa KIT REAR 
<b>RENAULT</b>						
<b>TRAFIC (EL)</b>						
KF 340	ABS / --> 11.02	1.9 dCi 100 (ELOC); 1.9 dCi 80 (ELOB)	60-74	03.01-		KB 339
KF 315	<del>ABS</del> / --> 11.02	1.9 dCi 100 (ELOC); 1.9 dCi 80 (ELOB)	60-74	03.01-		KB 339
KF 334	11.02 -->	1.9 dCi 100 (ELOC); 1.9 dCi 80 (ELOB)	60-74	03.01-		KB 339
KF 334		2.0 dCi	66-84	08.06-		KB 339
KF 340	ABS / --> 11.02	2.5 dCi 135 (ELOC)	99	03.01-		KB 339
KF 315	<del>ABS</del> / --> 11.02	2.5 dCi 135 (ELOC)	99	03.01-		KB 339
KF 334	11.02 -->	2.5 dCi 135 (ELOC)	99	03.01-		KB 339
KF 334		2.5 dCi	107	08.06-		KB 339
<b>TRAFIC (FL, JL)</b>						
KF 334		2.0 16V	86	08.06-		KB 339
KF 340	ABS / --> 11.02	2.0	88	03.01-		KB 339
KF 315	<del>ABS</del> / --> 11.02	2.0	88	03.01-		KB 339
KF 334	11.02 -->	2.0	88	03.01-		KB 339
KF 340	ABS / --> 11.02	dCi 100; dCi 80	60-74	03.01-		KB 339
KF 315	<del>ABS</del> / --> 11.02	dCi 100; dCi 80	60-74	03.01-		KB 339
KF 334	11.02 -->	dCi 100; dCi 80	60-74	03.01-		KB 339
KF 334		2.0 dCi; 2.5; 2.5 dCi	66-107	05.03-		KB 339
<b>TRAFIC (P6, T1 - T7)</b>						
		1.4 Bus	35	03.80-04.89		KA 091
		1.4 Bus	35	03.80-04.89	CH. --> C00005801	KA 049
KF 314	01.81 -->	1.4 Platform	35	03.80-04.89		
KF 314	01.81 -->	1.6 Platform	48	03.80-06.86		
KF 314		1.6 Bus	48	01.83-06.86		KA 091
KF 314		1.6 Bus	48	01.83-06.86	CH. --> C00005801	KA 049
KF 314		1.6 Bus	48	01.84-06.86	--> 12.85	KA 091
KF 314		1.6 Bus	48	01.84-06.86	01.86 -->	KA 049
KF 314		1.7 Bus	50	06.86-04.89		KA 091
KF 314		1.7 Bus	50	06.86-04.89	CH. --> C00005801	KA 049
KF 314	01.81 -->	2.0 Platform	59	03.80-04.89		
KF 314	01.81 -->	2.0 Platform	63	03.80-12.86		
KF 314	01.81 -->	2.1 D Platform	43	03.80-04.89		
KF 314		2.1 D Bus	43	09.80-04.89		KA 091
KF 314	01.81 -->	2.5 D Platform	51	03.80-04.89		
<b>TRAFIC (PXX, TXW, TXX)</b>						
KF 314		1.7 Bus	50	08.92-08.94		KA 269
KF 314		1.7 Bus; 2.0 Bus	50-59	05.89-08.94		KA 269
KF 314		2.2 Bus	74	06.94-10.97		KA 091
KF 314		2.1 D Bus	43	05.89-06.94		KA 091
KF 314		2.1 D Bus	43	05.89-06.94		KA 269
KF 314		2.1 D Bus	47	06.94-10.97		KA 091
KF 314		2.1 D Bus	47	06.94-10.97		KA 269
KF 314		2.1 D Platform; 2.5 D Platform	47-51	05.89-03.01		
<b>TWINGO</b>						
KB 192		1.1 (S066, C067, S068)	40-55	09.98-99		KB 193
KB 192		1.1 (S066, C067)	40-55	04.97-08.98		KB 045
KB 192		1.1 (S066, C067, S068)	40-55	09.98-99		KB 193
KB 048		1.1 Bus; 1.2; 1.2 Bus; 1.2 16V	40-55	03.93-		KB 045

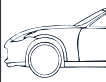
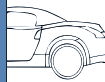

	<b>i</b>	<b>ENGINE</b>	<b>POWER (kW)</b>	<b>YEAR</b>	<b>i</b>	
Fersa KIT FRONT						Fersa KIT REAR
<b>RENAULT</b>						
<b>TWINGO</b>						
<b>KB 048</b>		1.1 Bus; 1.2; 1.2 Bus; 1.2 16V	40-55	03.93-		
<b>VEL SATIS (BJO)</b>						
<b>KF 334</b>		2.0 16 V Turbo; 2.0 16V Turbo; 3.5 V6	120-177	06.02-		
<b>KF 334</b>		2.0 dCi; 2.2 Cdi; 2.2 dCi; 2.2 dCi (BJOH); 3.0 Cdi	85-130	06.02-		
<b>KF 334</b>		3.0 dCi	133	06.06-		
<b>ROVER</b>						
<b>25 (RF)</b>						
<b>KF 099</b>		1.2 16V; 1.4 16V; 1.6 16V; 1.8 16V	55-107	10.99-		
<b>KF 099</b>		2.0IDT	74	10.99-		
<b>45 (RT)</b>						
<b>KF 101</b>		1.4	76	02.00-		
<b>KF 101</b>		1.6	80	02.00-		
<b>KF 101</b>		1.8; 2.0 V6	86-110	02.00-		
<b>KF 101</b>		2.0IDT	74	02.00-		
<b>200 (XH)</b>						
<b>KF 320</b>		213 S; 216; 216 VITESSE	54-75	03.85-09.89		<b>KV 100</b>
<b>200 (XW)</b>						
<b>KF 099</b>		214 Hatchback	55	09.93-10.95		
<b>KF 099</b>		214 1.4 Convertible	66	01.92-11.99	<b>ABS</b>	<b>KV 260</b>
<b>KF 099</b>		214 GSi/Si Hatchback; 214 Si/Gsi Hatchback	66-70	10.89-10.95		
<b>KF 099</b>		214 GSi/Si Hatchback	76	12.92-10.95		
<b>KF 099</b>		214 1.4i 16V Convertible	76	01.93-11.99	<b>ABS</b>	<b>KV 260</b>
<b>KF 099</b>		216 1.6i 16V Convertible	82	01.96-11.99		
<b>KF 099</b>		216 1.6i 16V Convertible	82	01.96-11.99	<b>ABS</b>	<b>KV 260</b>
<b>KF 099</b>		216 GSi Hatchback	82	10.89-10.95		
<b>KF 099</b>		216 GSi Hatchback	85	10.89-10.95		
<b>KF 099</b>		216 GSi Hatchback	85	10.89-10.95	<b>ABS</b>	<b>KV 260</b>
<b>KF 099</b>		216 GTi Hatchback	90	09.90-10.95		
<b>KF 099</b>		216 1.6i Convertible	90	01.92-11.99	<b>ABS</b>	<b>KV 260</b>
<b>KF 099</b>		216 Coupe	90	10.92-06.99		
<b>KF 099</b>		216 GTi Hatchback	96	09.90-10.95		
<b>KF 099</b>		216 GTi Hatchback	96	09.90-10.95	<b>ABS</b>	<b>KV 260</b>
<b>KF 099</b>		220 GSi Coupe	100	05.94-06.99		
<b>KF 099</b>		220 GTi Hatchback; 220 TURBO Hatchback	100-147	09.91-10.95		
<b>KF 099</b>		220 TURBO Coupe	147	10.92-06.99		
<b>KF 099</b>		218 TD Hatchback	65	09.91-10.95		
<b>KF 099</b>		218 D Hatchback	52	09.91-10.95		
<b>200 II (RF)</b>						
<b>KF 099</b>		211; 214 Si; 214i; 216 Si; 218 K Vi	44-107	11.95-03.00		
<b>KF 099</b>		220 D/SD; 220 SDi	63-77	11.95-03.00		
<b>400 (RT)</b>						
<b>KF 101</b>		414 Si	76	05.95-03.00		
<b>KF 101</b>		416 Si	82-83	05.95-03.00		
<b>KF 101</b>		420 Si Lux	100	12.95-03.00		
<b>KF 101</b>		420 2.0 D; 420 2.0 Di; 420 D; 420 Di	63-77	05.95-03.00		
<b>400 (XW)</b>						
<b>KF 099</b>		414; 414 GSi,Si	66-76	04.90-04.95		
<b>KF 099</b>		416 GSi	82	04.90-04.95		

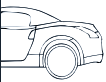

	<b>i</b>	<b>ENGINE</b>	<b>POWER (kW)</b>	<b>YEAR</b>	<b>i</b>	
Fersa KIT FRONT						Fersa KIT REAR
<b>ROVER</b>						
<b>400 (XV)</b>						
<b>KF 099</b>		1.6i TOURER	82	05.94-11.98		
<b>KF 099</b>		416 GSi/GSE	85	04.90-04.95		
<b>KF 099</b>		1.6i TOURER	90	05.94-11.98		
<b>KF 099</b>		416 GTi; 416 GTi/GTE	90-96	04.90-04.95		
<b>KF 099</b>		1.8i TOURER; 2.0i TOURER	100-107	05.94-11.98		
<b>KF 099</b>		2.0 Turbo GSi Sport; 420 Gsi/Sli/Gti/VITESSE; 420 Gti/Gsi/VITESSE; 420 TURBO	100-152	02.92-04.95		
<b>KF 099</b>		1.8 D TOURER	65	09.93-11.98		
<b>KF 099</b>		418 D; 418 SLD/GSD	49-65	09.91-04.95		
<b>600 (RH)</b>						
<b>KV 229</b>	<b>ABS</b>	618i,Si; 620 Si; 620 Ti VITESSE; 620i; 623 Si	85-147	08.93-02.99		
<b>KV 229</b>	<b>ABS</b>	620 SDi	77	12.94-02.99		
<b>MINI MK I</b>						
<b>KA 254</b>		1000; 1300	30-46	01.91-		
<b>STREETWISE</b>						
<b>KF 099</b>		1.4	62-76	08.03-		
<b>KF 099</b>		2.0 TD	74	08.03-		
<b>SAAB</b>						
<b>90</b>						
<b>KV 343</b>		1.8 i	90	01.04-		<b>KV 336</b>
		2.0 SE TURBO; 2.0 TURBO; 2.0i	96-151	02.98-08.03		<b>KV 252</b>
<b>KV 343</b>		1.8 t; 2.0 t; 2.0 Turbo Performance	110-185	09.02-		<b>KV 336</b>
		2.3i	110-165	02.98-08.03		<b>KV 252</b>
<b>KV 343</b>		2.8 T; 2.8 Turbo; 2.8 Turbo V6	184	03.05-		<b>KV 336</b>
<b>KV 343</b>		1.9 TiD	88-110	09.04-		<b>KV 336</b>
		2.2 TiD	85-92	02.98-09.02		<b>KV 252</b>
<b>KV 343</b>		2.2 TiD	92	09.02-		<b>KV 336</b>
		2.0 t Limousine; 2.0 t Estate Car	110	09.97-	CH. --> X3025751	<b>KV 252</b>
		2.0	136	07.00-	CH. --> X3025751	<b>KV 252</b>
		2.0 t Estate Car	141	10.98-	CH. --> X3025751	<b>KV 252</b>
		2.3 t Limousine; 2.3 t Estate Car	125	09.97-	CH. --> X3025751	<b>KV 252</b>
		2.3i Limousine	169	10.99-09.01	CH. --> X3025751	<b>KV 252</b>
		2.3i Estate Car	169	10.99-09.01	CH. --> X3025751	<b>KV 252</b>
		3.0 V6t Limousine; 3.0 V6t Estate Car	147	01.98-	CH. --> X3025751	<b>KV 252</b>
<b>900 I</b>						
		2.0-16 Convertible	93	01.90-06.94	01.94 -->	<b>KV 252</b>
		2.0 S TURBO-16 Convertible	104	09.91-06.94	01.94 -->	<b>KV 252</b>
		2.0 TURBO-16 Hatchback	118	11.85-06.94	01.94 -->	<b>KV 252</b>
		2.0 TURBO-16 Convertible	118	11.86-06.94	01.94 -->	<b>KV 252</b>
		2.0 TURBO-16 S Convertible	129	11.86-06.94	01.94 -->	<b>KV 252</b>
		2.0 TURBO-16 Hatchback	132	01.93-06.94	01.94 -->	<b>KV 252</b>
		2.1-16 Convertible	100	08.90-06.94	01.94 -->	<b>KV 252</b>
<b>900 II</b>						
		2.0-16 TURBO; 2.0i; 2.3-16; 2.5-24 V6	96-136	07.93-02.98		<b>KV 252</b>

	<b>i</b>	<b>ENGINE</b>	<b>POWER (kW)</b>	<b>YEAR</b>	<b>i</b>	
Fersa KIT FRONT						Fersa KIT REAR
<b>SEAT</b>						
<b>131</b>						
<b>KA 057</b>	--> 09.84	1.5	55	03.82-01.85	--> 09.84	<b>KC 253</b>
<b>KA 057</b>	--> 09.84	1.6; 2.0	71-85	06.78-12.85		<b>KC 253</b>
<b>KA 057</b>	--> 09.84	2.4 Diesel	53	06.78-12.86		<b>KC 253</b>
<b>133</b>						
<b>KA 213</b>		0.8	25	05.74-11.79		
<b>600 D</b>						
<b>KA 213</b>		D 0.8	17	09.63-04.70		<b>KA 210</b>
<b>ALHAMBRA (7V8, 7V9)</b>						
<b>KF 240</b>		1.8 T 20V; 2.0i SE; 2.8 VR6 24V	85-150	04.96-		<b>KF 241</b>
<b>KF 240</b>		2.8 V6 4	150	02.01-		<b>KF 240</b>
<b>KF 240</b>		1.9 TDI	66-110	04.96-		<b>KF 241</b>
<b>KF 240</b>		1.9 TDI 4motion; 1.9 Tdi 4x4	85-96	02.01-		<b>KF 240</b>
<b>KF 240</b>		2.0 TDI	103	11.05-		<b>KF 241</b>
<b>AROSA (6H)</b>						
<b>KF 181</b>		1.0i; 1.4i	37-74	97-		<b>KA 069</b>
<b>KF 181</b>		1.7 SDi	37-74	97-		<b>KA 069</b>
<b>KF 181</b>		1.0; 1.4; 1.4 16V	37-74	05.97-06.04	CH. --> 6H-X-027500	<b>KA 006</b>
<b>KF 181</b>		1.0; 1.4; 1.4 16V	37-74	05.97-06.04	CH. 6H-X-027501 -->	<b>KV 284</b>
<b>KF 181</b>		1.4 TDI; 1.7 DI	44-55	08.97-06.04	CH. --> 6H-X-027500	<b>KA 006</b>
<b>KF 181</b>		1.4 TDI; 1.7 DI	44-55	08.97-06.04	CH. 6H-X-027501 -->	<b>KV 284</b>
<b>CORDOBA (6K02.C2)</b>						
<b>KF 182</b>		1.0i; 1.4i; 1.4i 16V; 1.6 i; 1.6i; 1.8i; 1.8i 16V; 2.0i; 2.0i 16V	37-110	02.93-06.99	CH. --> 6K-X-399999	<b>KA 006</b>
<b>KF 182</b>		1.0i; 1.4i; 1.4i 16V; 1.6 i; 1.6i; 1.8i; 1.8i 16V; 2.0i; 2.0i 16V	37-110	02.93-06.99	CH. 6K-X-400000 -->	<b>KV 284</b>
<b>KF 182</b>		1.7 SDi; 1.9 D; 1.9 SDi; 1.9 TD; 1.9 TDI	44-81	02.93-06.99	CH. --> 6K-X-399999	<b>KA 006</b>
<b>KF 182</b>		1.7 SDi; 1.9 D; 1.9 SDi; 1.9 TD; 1.9 TDI	44-81	02.93-06.99	CH. 6K-X-400000 -->	<b>KV 284</b>
<b>KF 183</b>		2.0i 8V,16 V	44-81	93-		<b>KA 069</b>
<b>CORDOBA (6K5)</b>						
<b>KF 182</b>		1.4; 1.4 16V; 1.4i; 1.6; 1.6 i; 1.6i	44-74	09.96-	CH. --> 6K-X-290000	<b>KA 006</b>
<b>KF 182</b>		1.4; 1.4 16V; 1.4i; 1.6; 1.6 i; 1.6i	44-74	09.96-	CH. 6K-X-290001 -->	<b>KV 284</b>
<b>KF 182</b>		1.7 SDi; 1.9 SDi; 1.9 TDI	44-81	08.96-	CH. --> 6K-X-290000	<b>KA 006</b>
<b>KF 182</b>		1.7 SDi; 1.9 SDi; 1.9 TDI	44-81	08.96-	CH. 6K-X-290001 -->	<b>KV 284</b>
<b>KF 182</b>		1.4; 1.4 16V; 1.6; 1.8 T 20V	44-115	06.99-10.02	CH. --> 6K-X-399999	<b>KA 006</b>
<b>KF 182</b>		1.4; 1.4 16V; 1.6; 1.8 T 20V	44-115	06.99-10.02	CH. 6K-X-400000 -->	<b>KV 284</b>
<b>KF 182</b>		1.9 SDi; 1.9 TDI	50-81	06.99-10.02	CH. --> 6K-X-399999	<b>KA 006</b>
<b>KF 182</b>		1.9 SDi; 1.9 TDI	50-81	06.99-10.02	CH. 6K-X-400000 -->	<b>KV 284</b>
<b>CORDOBA (6L2)</b>						
<b>KV 287</b>		1.2; 1.2 12V; 1.4 16V; 1.6; 1.6 16V; 2.0	47-85	09.02-		<b>KV 286</b>
<b>KV 287</b>		1.4 TDI; 1.9 SDi; 1.9 TDI	47-96	09.02-		<b>KV 286</b>
<b>FURA (025A)</b>						
<b>KF 161</b>		0.9	29	03.84-12.86	ABS	<b>KV 162</b>
<b>IBIZA I (021A)</b>						
<b>KF 203</b>		0.9	29-32	08.86-05.93	--> 12.92	<b>KV 162</b>
<b>KF 203</b>		0.9	29-32	08.86-05.93	01.93 -->	<b>KA 006</b>
<b>KF 203</b>	--> 05.93	1.2	44-47	11.84-12.93		
<b>KF 182</b>	06.93 -->	1.2	44-47	11.84-12.93		
		1.2	44-47	11.84-12.93	--> 12.92	<b>KV 162</b>
		1.2	44-47	11.84-12.93	01.93 -->	<b>KA 006</b>
<b>KF 203</b>		1.2i; 1.5; 1.5i; 1.7	52-76	11.84-05.93	ABS	<b>KV 162</b>
<b>KF 203</b>		1.7 D	40-42	06.84-05.93	ABS	<b>KV 162</b>
<b>IBIZA II (6K1)</b>						
<b>KF 182</b>		1.0; 1.0i; 1.3i; 1.4i 16V; 1.4i GLX; 1.6 i; 1.6i; 1.8i; 1.8i GTI 16V; 2.0i; 2.0i 16V	33-110	03.93-08.99		<b>KA 006</b>

	<b>i</b>	<b>ENGINE</b>	<b>POWER (kW)</b>	<b>YEAR</b>	<b>i</b>	
Fersa KIT FRONT						Fersa KIT REAR
<b>SEAT</b>						
<b>IBIZA II (6K1)</b>						
<b>KF 182</b>		1.0; 1.0i; 1.3i; 1.4i 16V; 1.4i GLX; 1.6 i; 1.6i; 1.8i; 1.8i GTI 16V; 2.0i; 2.0i 16V	33-110	03.93-08.99		
<b>KF 182</b>		1.7 SDI; 1.9 D; 1.9 SDI; 1.9 TD; 1.9 TDI	44-81	03.93-08.99		<b>KA 006</b>
<b>KF 182</b>		1.7 SDI; 1.9 D; 1.9 SDI; 1.9 TD; 1.9 TDI	44-81	03.93-08.99		
<b>IBIZA III (6K1)</b>						
<b>KF 182</b>		1.0; 1.0 16V; 1.4; 1.4 16V; 1.6; 1.8 T 20V	37-115	08.99-02.02		
<b>KF 182</b>		1.0; 1.0 16V; 1.4; 1.4 16V; 1.6; 1.8 T 20V	37-115	08.99-02.02	CH. --> 6K-X-399999	<b>KA 006</b>
<b>KF 182</b>		1.0; 1.0 16V; 1.4; 1.4 16V; 1.6; 1.8 T 20V	37-115	08.99-02.02	CH. 6K-X-400000 -->	<b>KV 284</b>
<b>KF 182</b>		1.9 SDI; 1.9 TDI	50-81	08.99-02.02	CH. --> 6K-X-399999	<b>KA 006</b>
<b>KF 182</b>		1.9 SDI; 1.9 TDI	50-81	08.99-02.02	CH. 6K-X-400000 -->	<b>KV 284</b>
<b>IBIZA IV (6L)</b>						
<b>KV 287</b>		1.2; 1.2 12V; 1.4; 1.4 16V; 1.6; 1.6 16V; 1.8 T Cupra R; 1.8 T FR	47-132	02.02-		<b>KV 286</b>
<b>KV 287</b>		1.4 TDI; 1.9 SDI; 1.9 TDI; 1.9 TDI Cupra R	47-118	02.02-		<b>KV 286</b>
<b>INCA (6K9)</b>						
<b>KF 182</b>		1.4 16V; 1.4i; 1.6i	44-55	11.95-	CH. --> 9K-V-015942	<b>KA 005</b>
<b>KF 182</b>		1.4 16V; 1.4i; 1.6i	44-55	11.95-	CH. 9K-V-015943 --> / CH. --> 9K-X-023408	<b>KA 248</b>
<b>KF 182</b>		1.7 D; 1.9 D; 1.9 SDI; 1.9 TDI	42-66	11.95-	CH. --> 9K-V-015942	<b>KA 005</b>
<b>KF 182</b>		1.7 D; 1.9 D; 1.9 SDI; 1.9 TDI	42-66	11.95-	CH. 9K-V-015943 --> / CH. --> 9K-X-023408	<b>KA 248</b>
<b>LEON (1M)</b>						
<b>KF 184</b>		1.4 16V; 1.6; 1.6 16V; 1.8 20V; 1.8 T 20V; 1.8 T Cupra R	55-154	11.99-		<b>KV 194</b>
		1.8 T Cupra R	165	07.03-		<b>KF 184</b>
<b>KF 184</b>		1.8 T 20V 4; 2.8 Cupra 4	132-150	11.99-		<b>KF 184</b>
<b>KF 184</b>		1.9 SDI; 1.9 TDI; 1.9 TDI Syncro	50-110	11.99-		<b>KV 194</b>
<b>KF 184</b>		1.8i, 1.8i 20 V, ABS	50-110	99-		<b>KA 069</b>
<b>KF 184</b>		1.9 Tdi, ABS	50-110	99-		<b>KA 069</b>
<b>MALAGA (023A)</b>						
<b>KF 203</b>		1.2; 1.2i; 1.4i; 1.5	44-74	11.84-12.93		<b>KV 162</b>
<b>KF 203</b>		1.7 D	40-42	05.85-12.93		<b>KV 162</b>
<b>MARBELLA (208.028A)</b>						
<b>KV 163</b>		0.8; 0.9	25-30	08.86-10.98		<b>KV 204</b>
<b>RONDA (022A)</b>						
<b>KF 203</b>		1.2; 1.4; 1.6	44-68	06.82-11.88		<b>KV 162</b>
<b>KF 203</b>		1.7 D	40-41	06.82-12.86		<b>KV 162</b>
<b>TERRA (24)</b>						
<b>KV 163</b>		0.9	29	01.87-12.96		<b>KV 204</b>
<b>KV 163</b>		1.3 D; 1.4 D	33-35	03.90-12.95		<b>KV 204</b>
<b>TOLEDO I (1L)</b>						
<b>KF 182</b>		1.6i; 1.8 16V; 1.8 GT; 1.8i; 2.0i	52-102	05.91-03.99		<b>KA 006</b>
		1.6i; 1.8 16V; 1.8 GT; 1.8i; 2.0i	52-102	05.91-03.99		<b>KA 006</b>
<b>KF 182</b>		1.6i; 1.8 16V; 1.8 GT; 1.8i; 2.0i	52-102	05.91-03.99		
<b>KF 183</b>		2.0i 16V	110	11.93-03.99		<b>KA 006</b>
<b>KF 183</b>		2.0i 16V	110	11.93-03.99		
<b>KF 182</b>		1.9 D; 1.9 SDI; 1.9 TD; 1.9 TDI	47-81	05.91-03.99		<b>KA 006</b>
		1.9 D; 1.9 SDI; 1.9 TD; 1.9 TDI	47-81	05.91-03.99		<b>KA 006</b>
<b>KF 182</b>		1.9 D; 1.9 SDI; 1.9 TD; 1.9 TDI	47-81	05.91-03.99		
<b>TOLEDO II (1M2)</b>						
<b>KF 184</b>		1.4 16V; 1.6; 1.8 20Vi; 1.8 20VT; 2.3 V5; 2.3 V5 20V	55-132	04.99-05.06		<b>KV 194</b>
		1.4 16V; 1.6; 1.8 20Vi; 1.8 20VT; 2.3 V5; 2.3 V5 20V	55-132	04.99-05.06		<b>KV 194</b>
<b>KF 184</b>		1.9 SDI; 1.9 TDI	50-110	04.99-05.06		<b>KV 194</b>
		1.9 SDI; 1.9 TDI	50-110	04.99-05.06		<b>KV 194</b>

	<b>i</b>	ENGINE	POWER (kW)	YEAR	<b>i</b>	
Fersa KIT FRONT						Fersa KIT REAR
<b>SKODA</b>						
<b>100</b>						
		1.0	29-31	01.70-12.77		<b>KD 348</b>
<b>105,120 (742)</b>						
		1.0 105 S,L,GL	33	08.76-08.83		<b>KD 348</b>
		1.0 105 S,L; 1.2 120 L; 1.2 120 LS	34-43	08.76-12.90	--> 12.89	<b>KD 348</b>
		1.0 105 S,L; 1.0 105 S,L,LS; 1.2 120 GLS; 1.2 120 L	32-43	02.83-12.90	--> 12.89	<b>KD 348</b>
<b>110</b>						
		1.1 L; 1.1 LS; 1.1 R	33-38	12.69-03.82	--> 12.77	<b>KD 348</b>
<b>FABIA (5J)</b>						
<b>KV 287</b>		1.2; 1.4; 1.6	44-77	03.07-		
<b>KV 287</b>		1.2; 1.4; 1.6	44-77	03.07-		<b>KV 286</b>
<b>KV 287</b>		1.4 TDI; 1.9 TDI	51-77	03.07-		<b>KV 286</b>
<b>FABIA (6Y)</b>						
<b>KV 287</b>		1.0	37	12.99-08.02		<b>KV 286</b>
<b>KV 287</b>		1.2; 1.4 16V	40-55	10.99-		<b>KV 286</b>
<b>KV 287</b>		1.4 16V	59	04.06-		<b>KV 286</b>
<b>KV 287</b>		1.4; 1.4 16V	44-74	12.99-		<b>KV 286</b>
<b>KV 287</b>		1.4	44	04.00-08.02		<b>KV 286</b>
<b>KV 287</b>		1.4	44	08.00-08.02		<b>KV 286</b>
<b>KV 287</b>		1.4; 2.0	50-85	08.99-		<b>KV 286</b>
<b>KV 287</b>		1.4 TDI	51	10.05-		<b>KV 286</b>
<b>KV 287</b>		1.4 TDI	55	04.03-		<b>KV 286</b>
<b>KV 287</b>		1.4 TDI	59	10.05-		<b>KV 286</b>
<b>KV 287</b>		1.9 SDI; 1.9 TDI; RS	47-96	11.99-		<b>KV 286</b>
<b>FABIA PRAKTIK</b>						
<b>KV 287</b>		1.2; 1.4	40-50	04.02-		<b>KV 286</b>
<b>KV 287</b>		1.4 TDI	51	10.05-		<b>KV 286</b>
<b>KV 287</b>		1.9 SDI	47	04.02-		<b>KV 286</b>
<b>FAVORIT (781)</b>						
		1.3 135; 1.3 135 L; 1.3 135 X,LX,GLX; 1.3 136	40-45	05.89-09.94	05.93 -->	<b>KA 006</b>
		1.3 135; 1.3 135 L; 1.3 135 X,LX,GLX; 1.3 136	40-45	05.89-09.94	--> 04.93	<b>KA 054</b>
		1.3	50	01.94-09.94		<b>KA 006</b>
		1.3	40-50	12.92-06.97	05.93 -->	<b>KA 006</b>
		1.3	40-50	12.92-06.97	--> 04.93	<b>KA 054</b>
<b>FAVORIT 785 FORMAN (785)</b>						
		1.3 (135); 1.3 (135 E); 1.3 (136)	40-45	08.91-06.95	05.93 -->	<b>KA 006</b>
		1.3 (135); 1.3 (135 E); 1.3 (136)	40-45	08.91-06.95	--> 04.93	<b>KA 054</b>
		1.3	50	01.94-06.95		<b>KA 006</b>
<b>FELICIA I (791,795,797)</b>						
<b>KF 159</b>		1.3; 1.3 LX; 1.3 LXI; 1.6; 1.6 GLX; 1.6 LX	40-55	10.94-		<b>KA 006</b>
<b>KF 159</b>		1.9 D	47	10.95-		<b>KA 006</b>
<b>FELICIA II (6U1)</b>						
<b>KF 159</b>		1.3; 1.6	40-55	01.98-06.01		<b>KA 006</b>
<b>KF 159</b>		1.9 D	47	01.98-06.01		<b>KA 006</b>
<b>KF 159</b>		1.3; 1.6	50-55	01.98-06.01		<b>KA 006</b>
<b>KF 159</b>		1.9 D	47	01.98-06.01		<b>KA 006</b>
<b>OCTAVIA (1U)</b>						
<b>KF 184</b>		1.4; 1.6; 1.8 20V; 1.8 T; RS 1.8 T; RS 1.8 T 20V	44-132	09.96-		<b>KV 194</b>

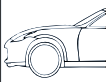
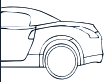
	<b>i</b>	ENGINE	POWER (kW)	YEAR	<b>i</b>	
Fersa KIT FRONT						Fersa KIT REAR
<b>SKODA</b>						
<b>OCTAVIA (1U)</b>						
		1.4; 1.6; 1.8 20V; 1.8 T; RS 1.8 T; RS 1.8 T 20V	44-132	09.96-		<b>KV 194</b>
<b>KF 184</b>		1.8 T 4x4	110	05.01-		<b>KF 184</b>
<b>KF 184</b>		2.0	85	04.99-		<b>KV 194</b>
		2.0	85	04.99-		<b>KV 194</b>
<b>KF 184</b>		2.0; 2.0 4x4	85-88	01.00-		<b>KF 184</b>
<b>KF 184</b>		1.9 SDI; 1.9 TDI; 1.9 TDI Estate Car	50-96	09.96-		<b>KV 194</b>
		1.9 SDI; 1.9 TDI; 1.9 TDI Estate Car	50-96	09.96-		<b>KV 194</b>
<b>KF 184</b>		1.9 TDI 4x4	66-74	11.99-		<b>KF 184</b>
<b>ROOMSTER (5J)</b>						
<b>KV 287</b>		1.2; 1.4; 1.6	47-77	09.06-		<b>KV 194</b>
<b>KV 287</b>		1.4 TDI; 1.9 TDI	51-77	09.06-		<b>KV 194</b>
<b>SUPERB (3U4)</b>						
<b>KF 096</b>		1.8 T	110	02.02-		
<b>KF 098</b>		1.8 T	110	02.02-		<b>KV 276</b>
<b>KF 096</b>		2.0	85	02.02-		<b>KV 276</b>
<b>KF 098</b>		2.8 V6	142	02.02-		<b>KV 276</b>
<b>KF 096</b>		1.9 TDI	74-85	08.02-		<b>KV 276</b>
		1.9 TDI	74-85	08.02-		<b>KV 276</b>
<b>KF 098</b>		1.9 TDI; 2.0 TDI; 2.5 TDI	96-120	02.02-		<b>KV 276</b>
<b>SUZUKI</b>						
<b>ALTO I (SS80)</b>						
<b>KC 223</b>		0.8 (SS80F;SS80G)	29	06.82-12.85		<b>KC 224</b>
<b>ALTO II (EC)</b>						
<b>KC 223</b>		0.8 (SB3008.CA)	29	01.86-11.93		<b>KC 224</b>
<b>ALTO III (EF)</b>						
<b>KF 301</b>		1.0	39	09.94-06.02		
<b>GRAND VITARA (FT,GT)</b>						
<b>KB 062</b>		1.6; 2.0; 2.5 V6 24V	69-106	03.98-		
<b>KB 062</b>		2.7 V6	127	09.01-		
<b>KB 062</b>		2.0 HDI 110	80	07.01-		
<b>KB 062</b>		2.0 TD Intercooler	64	03.98-		
<b>JIMNY (FJ)</b>						
<b>KA 061</b>		0.7; 0.7 4x4; 1.0; 1.3 4x4; 1.3 16V; 1.3 16V 4WD; 1.6 VWT	39-76	09.98-		
<b>KA 061</b>		1.5 DDiS; 1.5 DDiS 4WD	48-63	12.03-		
<b>SAMURAI (S.J)</b>						
<b>KA 061</b>		1.0 (SJ410); 1.3 (SJ413)	33-51	11.88-		<b>KC 265</b>
<b>KA 061</b>		1.9 TD	46	11.98-		<b>KC 265</b>
<b>SJ 410</b>						
<b>KA 061</b>		1.0 SJ413	33	09.81-12.88		
<b>SJ 413</b>						
<b>KA 061</b>		1.3 SJ413	44	08.86-08.90		
<b>KA 061</b>		1.3 SJ413	47	09.84-12.88		
<b>SWIFT I (AA)</b>						
<b>KC 223</b>		1.0 (SA310,AA401.43); 1.0 TURBO (SA310); 1.3 (SA413,AA51); 1.3 (SA413,AA501.53); 1.3 (SA413,AA53)	37-54	10.83-12.89		<b>KC 224</b>



	<b>i</b>	ENGINE	POWER (kW)	YEAR	<b>i</b>	
Fersa KIT FRONT						Fersa KIT REAR
<b>SUZUKI</b>						
SWIFT II (AH,AJ,EA)						
<b>KF 301</b>		1.0 (SF310,AA44); 1.0i (SF310,AA44); 1.3 (SF413,AB35)	37-50	03.89-05.01		
VITARA (ET,TA)						
<b>KF 301</b>		1.3 (SF413,AA35); 1.3 (SF413,AB35); 1.3 (SF413,AF35); 1.3 (SF413,AH35)	50-52	03.89-05.01		
<b>KB 062</b>		1.6 (ET); 1.6 (TA); 1.6 16V (ET); 2.0 16V (ET); 2.0 V6 24V (ET); 2.5 V6 24V (FT)	59-118	07.88-03.99		<b>KB 062</b>
<b>KB 062</b>		1.9 D (ET); 2.0 TD (ET); 2.0 TD INTERCOOLER (ET)	50-64	12.94-03.99		<b>KB 062</b>
<b>KB 062</b>		1.9 D (ET); 2.0 TD (ET); 2.0 TD INTERCOOLER (ET)	50-64	12.94-03.99		<b>KC 224</b>
<b>TALBOT</b>						
1610						
<b>KA 064</b>		180	35	71-81		
<b>KA 064</b>		1610	35	78-80		
1000 S 4 CV-5 CV						
<b>KA 059</b>		1000 S 4 CV-5 CV	35	69-70		
<b>KA 059</b>		1000 S 6 CV	35	69-72		
<b>KA 063</b>		1000 GLS-LS-Rallye	35	73-77		
<b>KA 063</b>		1000 GLS 6 CV	35	77		
<b>KA 063</b>		1000 LS-GLS	35	66-78		
<b>KA 063</b>		1000 Rally	35	72-78		
<b>KA 063</b>		1000 S 4 CV-5 CV	35	73-75		
1200						
<b>KF 172</b>		1200 TI	43	76-79		<b>KA 060</b>
		1200 GL,GLE,GLS	43	73-79		<b>KA 063</b>
<b>KF 172</b>		1200 LS,LX	43	79-83		<b>KA 063</b>
		1204 Special	43	70-79		<b>KA 063</b>
1300 - 1500						
<b>KA 063</b>		1300,130	43	63-75		<b>KA 063</b>
<b>KA 063</b>		1500,15001	44	63-76		<b>KA 063</b>
<b>KF 172</b>		1307 1,3	40	01.78-08.81		
<b>KF 172</b>	01.78 -->	1307 1.3; 1307 1.3 S	44-60	07.75-01.80		
<b>KF 172</b>		1308 1.4; 1510 1.6	55-66	11.78-06.82		
HORIZON						
<b>KF 172</b>		1.1; 1.3; 1.4; 1.6	40-66	02.78-06.86		
<b>KF 172</b>		1.9 D	47-48	07.82-06.86		
MATRA BAGHEERA (X)						
<b>KF 172</b>	CH. 38516 -->	1.3 (X3550)	62	01.74-03.78		
<b>KF 172</b>	CH. 38516 -->	1.4 (X6)	62	11.79-09.80		
<b>KF 172</b>	CH. 38516 -->	1.4 (X6); 1.4 (X6550)	66	12.75-09.80		
RANCHO						
<b>KF 172</b>		1.4	59	01.77-07.84		
S Coupé 1200						
<b>KA 059</b>		S Coupé 1200	59	68-71		<b>KA 063</b>
SAMBA (51A,51E)						
		0.9; 1.1; 1.2 RALLYE; 1.4; 1.4 RALLYE	31-65	01.81-10.86		<b>KA 073</b>
SIMCA 1100						
<b>KF 172</b>	CH. 8202418 -->	0.9 LE	35	10.76-01.80		
<b>KF 172</b>	CH. 8202418 -->	1.1; 1.1 LE,LX,GLS,ES	37	10.76-01.80		
<b>KF 172</b>	CH. 8202418 -->	1.1 LE,LX,GLS,ES	43	10.76-01.80		
<b>KF 172</b>	CH. 8202418 -->	1.1	44	10.76-09.79		

	<b>i</b>	<b>ENGINE</b>	<b>POWER (kW)</b>	<b>YEAR</b>	<b>i</b>	
Fersa KIT FRONT						Fersa KIT REAR
<b>TALBOT</b>						
<b>SOLARA</b>						
<b>KF 172</b>		1.3; 1.6	40-66	02.80-07.86		
<b>TAGORA</b>						
<b>KA 041</b>		2.1; 2.6	85-122	06.80-12.83		<b>KF 141</b>
<b>KA 041</b>	--> 12.83	2.3 TD	59	08.81-12.87	--> 12.83	<b>KF 141</b>
<b>TOYOTA</b>						
<b>AVENSIS VERSO</b>						
<b>KF 309</b>	--> 07.05	2.0 WT-i; 2.4 WTi GLS	110-115	08.01-		
<b>KF 309</b>	--> 07.05	D4-D	85	08.01-		
<b>CAMRY (_V1_/_V10)</b>						
<b>KF 316</b>		2.2 (SXV10); 2.2 GL (SXV10); 3.0 (VCV10)	100-138	06.91-08.96		
<b>KF 259</b>	08.88 -->	2.0 GLi 16V (SV21) Limousine	89	11.86-05.91	08.88 -->	<b>KF 173</b>
<b>KF 259</b>	08.88 -->	2.0 GLi 16V (SV21) Estate Car	89	11.86-05.91		
<b>KF 259</b>	08.88 -->	2.0 (SV21) Limousine	94	11.86-05.91	08.88 -->	<b>KF 173</b>
<b>KF 259</b>	08.88 -->	2.0 (SV21) Estate Car	94	11.86-05.91		
<b>KF 316</b>		2.2 (SXV20) Limousine	96	08.96-11.01		
<b>KF 259</b>	08.88 -->	2.5 V6 GXi (VZV21) Limousine	118	02.88-05.91	08.88 -->	<b>KF 173</b>
<b>KF 259</b>		2.5 (VZV21) Estate Car	118	01.90-05.91		
		2.0 TD Limousine; 2.0 TD (CV20) Limousine	62-63	11.86-05.91		<b>KF 173</b>
<b>CAMRY (_V30)</b>						
<b>KF 316</b>		2.4 WT-i; 3.0 V6	112-137	11.01-		
<b>CAMRY (V1)</b>						
		1.8; 2.0 GLI	66-79	02.83-10.86		<b>KF 173</b>
<b>CARINA (TA4L,TA6L,TA4K,TA6K)</b>						
<b>KA 065</b>		1.6 (TA4K) Estate Car	54	03.81-01.82		<b>KC 174</b>
<b>KA 066</b>		1.6 (TA4L) Limousine	55	01.78-09.83		
<b>KA 065</b>		1.6 (TA4L) Limousine	55	01.78-09.83		
		1.6 (TA4L) Limousine	55	01.78-09.83		<b>KC 174</b>
<b>CARINA E (_T19_)</b>						
<b>KF 259</b>	<b>ABS</b>	1.6 (AT190) Limousine	73	01.95-09.97		
<b>KF 259</b>	<b>ABS</b>	1.6 (AT190) Limousine; 1.6 GLi Estate Car; 1.6 GLi (AT190) Limousine; 1.6 GLi (AT190) Hatchback	78-79	04.92-09.97		
<b>KF 259</b>	<b>ABS</b>	1.8 (AT191) Hatchback; 1.8i Estate Car; 1.8i (AT191) Limousine; 2.0i (ST191) Limousine	79-93	12.92-09.97		
<b>KF 259</b>	<b>ABS</b>	2.0 (ST191) Limousine; 2.0 GLi (ST191) Limousine	98	04.92-09.97		
<b>KF 259</b>	<b>ABS</b>	2.0i 16V Limousine	129	03.94-09.97		
<b>KF 259</b>	<b>ABS</b>	2.0 D (CT190) Limousine	54	08.92-01.96		
<b>CARINA II (_T15_)</b>						
		1.6 (AT151); 1.8 GLi (ST150)	55-74	10.83-11.87		<b>KF 173</b>
		2.0 D (CT150)	51	12.85-11.87		<b>KF 173</b>
		1.6 (AT171); 2.0 GLi (ST171)	66-89	12.87-03.92		<b>KF 173</b>
		2.0 D (CT170)	54	12.87-01.92		<b>KF 173</b>
<b>CELICA (_T18_)</b>						
<b>KF 259</b>	<b>ABS / --&gt; 11.93</b>	1.6 STi (AT180); 2.0 GTi (ST182)	77-115	10.89-01.94	<b>ABS / --&gt; 11.93</b>	<b>KF 173</b>
<b>KF 259</b>	<b>ABS / --&gt; 11.93</b>	2.0 TURBO (ST185)	150-153	10.89-01.94		
<b>CELICA (ST16,T16,T16F)</b>						
		2.0; 2.0 GT; 2.0 GT (ST162)	103-110	08.85-08.90		<b>KF 173</b>
<b>CELICA (TA2)</b>						
<b>KA 065</b>		1.6 GT (TA2,TA22); 1.6 LT (TA2); 1.6 LT (TA22); 1.6 ST (TA22)	55-79	05.73-03.78		
<b>CELICA (TA4C,TA60)</b>						
<b>KA 066</b>		1.6 LT; 1.6 ST	55-66	08.77-08.85		<b>KC 174</b>
<b>KA 065</b>		1.6 LT; 1.6 ST	55-66	08.77-08.85		<b>KC 174</b>



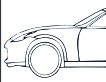
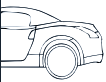

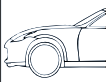
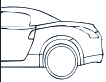

	<b>i</b>	ENGINE	POWER (kW)	YEAR	<b>i</b>	
Fersa KIT FRONT						Fersa KIT REAR
<b>TOYOTA</b>						
<b>CELICA (TA4C,TA60)</b>						
<b>KA 065</b>		1.6 GT	81	04.80-02.82		<b>KC 174</b>
<b>CELICA (TA60,RA40,RA6_)</b>						
<b>KA 066</b>		1.6 ST; 1.6 ST (TA60); 2.0 GT (RA63); 2.0 XT (RA40)	63-90	08.77-08.85		<b>KC 174</b>
<b>KA 065</b>		1.6 ST; 1.6 ST (TA60); 2.0 GT (RA63); 2.0 XT (RA40)	63-90	08.77-08.85		<b>KC 174</b>
<b>KA 066</b>		2.0 XT (RA61)	77	02.82-08.85		
<b>CELICA SUPRA (MA61)</b>						
<b>KA 066</b>		2.8i	125	05.82-10.86		
<b>COROLLA (_E7_)</b>						
<b>KA 065</b>		1.3 (KE70) Limousine; 1.3 (KE70) Hatchback; 1.3 (KE70) Estate Car; 1.6 (TE71) Hatchback	44-54	09.79-08.87		
<b>KA 065</b>		1.6 (TE71) Limousine	55	10.82-09.83		<b>KC 174</b>
<b>KA 065</b>		1.6 (TE71) Hatchback	55-63	09.79-05.83		
<b>KA 065</b>		1.6 GT (TE71) Hatchback	81	05.80-09.83		<b>KC 174</b>
<b>KA 065</b>		1.8 D (TE71) Limousine	43	01.83-09.83		<b>KC 174</b>
<b>COROLLA (_E10_)</b>						
<b>KF 298</b>		1.8 XL 4x4	53-92	07.92-04.97		
<b>KF 197</b>	<b>ABS</b>	1.8 XL 4x4	53-92	07.92-04.97		
<b>KF 298</b>		2.0 D Limousine; 2.0 D Hatchback; 2.0 D Estate Car	53	07.92-04.97		
<b>KF 197</b>	<b>ABS</b>	2.0 D Limousine; 2.0 D Hatchback; 2.0 D Estate Car	53	07.92-04.97		
<b>COROLLA (_E11_)</b>						
<b>KF 298</b>	ABS / --> 06.98	1.3 Limousine; 1.3 Hatchback; 1.3 Estate Car; 1.6 Limousine; 1.6 Hatchback; 1.6 Estate Car	63-81	04.97-02.00		
<b>KF 197</b>	<b>ABS</b> / --> 06.98	1.3 Limousine; 1.3 Hatchback; 1.3 Estate Car; 1.6 Limousine; 1.6 Hatchback; 1.6 Estate Car	63-81	04.97-02.00		
<b>KF 298</b>	07.98 -->	1.3 Limousine; 1.3 Hatchback; 1.3 Estate Car; 1.6 Limousine; 1.6 Hatchback; 1.6 Estate Car	63-81	04.97-02.00		
<b>KF 298</b>	ABS / --> 06.98	2.0 D Limousine; 2.0 D Hatchback; 2.0 D Estate Car	53	04.97-02.00		
<b>KF 197</b>	<b>ABS</b> / --> 06.98	2.0 D Limousine; 2.0 D Hatchback; 2.0 D Estate Car	53	04.97-02.00		
<b>KF 298</b>	07.98 -->	2.0 D Limousine; 2.0 D Hatchback; 2.0 D Estate Car	53	04.97-02.00		
<b>COROLLA (KE,TE)</b>						
<b>KA 002</b>		1.2 (KE20,KE25,KE30) Limousine	40	08.74-12.80		
<b>KA 065</b>		1.2 (KE20,KE25,KE30) Limousine	40	08.74-12.80		
<b>KA 065</b>		1.2 (KE36) Estate Car	40	07.75-01.80		
<b>KA 002</b>		1.2 (KE20,KE25) Limousine	43	10.72-06.77		
<b>KA 065</b>		1.2 (KE35)	40	07.75-01.80		
<b>CORONA (RT118)</b>						
<b>KA 066</b>	--> 12.78	2.0	65	09.75-05.79	--> 12.78	<b>KC 174</b>
<b>KA 065</b>		2.0 MARK II (RX22)	65	12.75-10.77		
<b>KA 065</b>		2.0 MARK II (RX12)	65	12.75-10.77		
<b>KA 066</b>		2.0 (RT104)	65	01.76-05.79		<b>KC 174</b>
<b>CRESSIDA (_X6_)</b>						
<b>KA 066</b>		2.0 (RX60); 2.0 GLI	77-80	05.81-03.85		<b>KC 174</b>
<b>KA 066</b>		2.0 (RX30); 2.0 (RX35)	66	07.77-07.81		<b>KC 174</b>
<b>HIACE I (_H_)</b>						
<b>KA 070</b>		1.6	49	01.79-12.84		
<b>HIACE II (H5_)</b>						
<b>KA 070</b>		2.0 (H5G)	65	01.85-08.89		
<b>KA 070</b>		2.4 D (H5G)	55	08.84-08.89		
<b>HIACE III (_H10_)</b>						
<b>KA 070</b>	--> 02.93	2.0 (RZH102) Bus	74	08.89-08.95		
<b>KA 070</b>		2.0	74	02.90-08.95		

	<b>i</b>	ENGINE	POWER (kW)	YEAR	<b>i</b>	
Fersa KIT FRONT						Fersa KIT REAR
<b>TOYOTA</b>						
<b>HIACE III ( _H10_ )</b>						
<b>KA 070</b>		2.4 Bus	88	08.89-08.95		
<b>KA 070</b>	--> 02.93	2.4i (RZH103) Bus	88	08.89-08.95		
<b>KA 070</b>	--> 02.93	2.4 D (LH102) Bus	55	08.89-08.95		
<b>KA 070</b>		2.4 D Bus	55	02.90-08.95		
<b>LITEACE ( _CM30_G,KM30_G )</b>						
<b>KA 066</b>		1.5 (M3G)	51	10.85-08.89		
<b>KA 067</b>		1.5 (M3G)	51	10.85-08.89		
		1.5 (M3G)	51	10.85-08.89		<b>KC 174</b>
<b>LITEACE ( _M2_ )</b>						
<b>KA 066</b>		1.3	42	10.79-10.86		<b>KC 174</b>
<b>MODELL F ( _R2_,31 )</b>						
<b>KA 066</b>		1.8 DE LUXE (YR20)	58	11.82-08.84		<b>KC 174</b>
<b>KA 066</b>	--> 09.85	2.0 SUPER (YR21)	65	08.84-08.88	--> 09.85	<b>KC 174</b>
<b>MR 2 ( _W1_ )</b>						
		1.6 16V (AW11)	85-91	11.84-06.90	08.86 --> / --> 01.89	<b>KF 259</b>
<b>MR 2 ( _W2_ )</b>						
		2.0; 2.0 16V; 2.0 16V (SW20)	88-129	12.89-05.00		<b>KF 316</b>
<b>PASEO (EL54)</b>						
<b>KF 310</b>	<b>ABS</b>	1.5 16V	66	08.95-07.99		
<b>PICNIC ( _XM10 )</b>						
<b>KF 316</b>	--> 05.01	2.0; 2.0 16V	90-94	05.96-12.01		
<b>KF 309</b>	06.01 -->	2.0; 2.0 16V	90-94	05.96-12.01		
<b>KF 316</b>	--> 05.01	2.2 D	66	08.97-12.01		
<b>KF 309</b>	06.01 -->	2.2 D	66	08.97-12.01		
<b>RAV 4 I (SXA1_)</b>						
<b>KF 259</b>	<b>ABS</b>	2.0 16V	94-95	06.94-06.00		
<b>RAV 4 II (XA2)</b>						
<b>KF 309</b>	--> 11.05	1.8 VWTi; 2.0 VWTi 4WD	92-110	06.00-		
<b>KF 309</b>		2.4 VWTi 4x4	112	08.03-10.05		
<b>KF 309</b>	--> 11.05	2.0 D4-D 4WD	85	09.01-		
<b>STARLET I (KP6_)</b>						
<b>KA 002</b>		1.0 (KP60); 1.2; 1.2 S (KP62); 1.3 S (KP61)	33-48	02.78-09.84		
<b>VAUXHALL</b>						
<b>AGILA</b>						
<b>KF 342</b>		1.0 12V; 1.2 16V	43-55	09.00-		<b>KF 341</b>
<b>ARENA</b>						
		1.9 D	44	03.98-08.01		<b>KA 269</b>
		2.5 D	55	03.98-08.01		<b>KA 269</b>
<b>ASTRA</b>						
<b>KF 133</b>		1.2 S; 1.3 S	44-55	09.79-08.84		<b>KA 007</b>
<b>KF 133</b>		1.2 S; 1.3 S	44-55	09.79-08.84		
<b>KF 134</b>	<b>ABS</b>	1.6 S; 1.8 GTE	66-85	09.81-08.86		<b>KA 007</b>
<b>KF 134</b>	<b>ABS</b>	1.6 D	40	02.82-08.86		<b>KA 007</b>
<b>KF 134</b>	<b>ABS</b>	1.6 D	40	02.82-08.86		<b>KA 007</b>
<b>ASTRA MK II</b>						
<b>KF 133</b>		1.2 Hatchback; 1.2 Estate Car; 1.3 Limousine; 1.3 Hatchback; 1.3 Estate Car; 1.4 Hatchback; 1.4i Limousine; 1.4i Hatchback	44-55	09.84-12.91		<b>KA 007</b>





		<b>i</b>	<b>ENGINE</b>	<b>POWER (kW)</b>	<b>YEAR</b>	<b>i</b>	
Fersa KIT FRONT							Fersa KIT REAR
<b>VAUXHALL</b>							
<b>ASTRA MK II</b>							
<b>KF 137</b>			1.2 Hatchback; 1.2 Estate Car; 1.3 Limousine; 1.3 Hatchback; 1.3 Estate Car; 1.4 Hatchback; 1.4i Limousine; 1.4i Hatchback	44-55	09.84-12.91		<b>KA 007</b>
<b>KF 133</b>			1.4 Estate Car	55	01.89-08.91		<b>KA 007</b>
<b>KF 133</b>			1.6 S Limousine; 1.6i; 1.6i Convertible	55-60	10.87-08.93		<b>KA 007</b>
<b>KF 137</b>			1.6 S Limousine; 1.6i; 1.6i Convertible	55-60	10.87-08.93		<b>KA 007</b>
<b>KF 133</b>			1.6 Hatchback	60	09.84-08.91		<b>KA 007</b>
<b>KF 133</b>			1.6 Estate Car; 1.6i Convertible	60	09.84-12.91		<b>KA 007</b>
<b>KF 137</b>			1.6 Estate Car; 1.6i Convertible	60	09.84-12.91		<b>KA 007</b>
<b>KF 134</b>			1.6 Limousine; 1.6 S Hatchback; 1.6 S Estate Car; 1.8 Limousine; 1.8 GTE Hatchback; 1.8i Limousine; 1.8i Estate Car	66-85	09.84-08.91		<b>KA 007</b>
<b>KF 133</b>			2.0i; 2.0i Convertible	85	01.87-08.93		<b>KA 007</b>
<b>KF 137</b>			2.0i; 2.0i Convertible	85	01.87-08.93		<b>KA 007</b>
<b>KF 134</b>			2.0 GTE Hatchback; 2.0 GTE 16V Hatchback	95-115	09.86-08.91		<b>KA 007</b>
<b>KF 134</b>			1.5 DT Limousine; 1.6 D Limousine; 1.6 D Hatchback; 1.6 D Estate Car; 1.7 D Limousine; 1.7 D Hatchback; 1.7 D Estate Car	40-53	09.84-12.91		<b>KA 007</b>
<b>ASTRA MK III</b>							
<b>KF 133</b>	CH. --> P*999999		1.4; 1.4i	44-55	09.91-09.98	ABS	<b>KV 202</b>
<b>KF 137</b>	CH. R*000001 -->		1.4; 1.4i	44-55	09.91-09.98	ABS	<b>KV 202</b>
<b>KF 133</b>	CH. --> P*999999		1.4; 1.4i	44-55	09.91-09.98	<del>ABS</del>	<b>KV 235</b>
<b>KF 137</b>	CH. R*000001 -->		1.4; 1.4i	44-55	09.91-09.98	<del>ABS</del>	<b>KV 235</b>
<b>KF 133</b>	CH. --> NE299999		1.4i	60	03.91-02.98	ABS	<b>KV 202</b>
<b>KF 133</b>	CH. --> P*999999 / [A.T]		1.4i	60	03.91-02.98	ABS	<b>KV 202</b>
<b>KF 133</b>	CH. --> P5077914		1.4i	60	03.91-02.98	ABS	<b>KV 202</b>
<b>KF 134</b>	CH. --> P*999999 / [M.T]		1.4i	60	03.91-02.98	ABS	<b>KV 202</b>
<b>KF 134</b>	CH. --> P*999999		1.4i	60	03.91-02.98	ABS	<b>KV 202</b>
<b>KF 134</b>	CH. --> P*999999		1.4i	60	03.91-02.98	ABS	<b>KV 202</b>
<b>KF 134</b>	CH. --> P*999999		1.4i	60	03.91-02.98	ABS	<b>KV 202</b>
<b>KF 137</b>	CH. R*000001 -->		1.4i	60	03.91-02.98	ABS	<b>KV 202</b>
<b>KF 133</b>	CH. --> NE299999		1.4i	60	03.91-02.98	<del>ABS</del>	<b>KV 235</b>
<b>KF 133</b>	CH. --> P*999999 / [A.T]		1.4i	60	03.91-02.98	<del>ABS</del>	<b>KV 235</b>
<b>KF 133</b>	CH. --> P5077914		1.4i	60	03.91-02.98	<del>ABS</del>	<b>KV 235</b>
<b>KF 134</b>	CH. --> P*999999 / [M.T]		1.4i	60	03.91-02.98	<del>ABS</del>	<b>KV 235</b>
<b>KF 134</b>	CH. --> P*999999		1.4i	60	03.91-02.98	<del>ABS</del>	<b>KV 235</b>
<b>KF 134</b>	CH. --> P*999999		1.4i	60	03.91-02.98	<del>ABS</del>	<b>KV 235</b>
<b>KF 134</b>	CH. --> P*999999		1.4i	60	03.91-02.98	<del>ABS</del>	<b>KV 235</b>
<b>KF 137</b>	CH. R*000001 -->		1.4i	60	03.91-02.98	<del>ABS</del>	<b>KV 235</b>
<b>KF 133</b>	CH. --> NE299999		1.4i	60	03.92-02.98	ABS	<b>KV 202</b>
<b>KF 133</b>	CH. --> P*999999 / [A.T]		1.4i	60	03.92-02.98	ABS	<b>KV 202</b>
<b>KF 133</b>	CH. --> P5077914		1.4i	60	03.92-02.98	ABS	<b>KV 202</b>
<b>KF 134</b>	CH. --> P*999999 / [M.T]		1.4i	60	03.92-02.98	ABS	<b>KV 202</b>
<b>KF 134</b>	CH. --> P*999999		1.4i	60	03.92-02.98	ABS	<b>KV 202</b>
<b>KF 134</b>	CH. --> P*999999		1.4i	60	03.92-02.98	ABS	<b>KV 202</b>
<b>KF 137</b>	CH. R*000001 -->		1.4i	60	03.92-02.98	ABS	<b>KV 202</b>
<b>KF 133</b>	CH. --> NE299999		1.4i	60	03.92-02.98	<del>ABS</del>	<b>KV 235</b>
<b>KF 133</b>	CH. --> P*999999 / [A.T]		1.4i	60	03.92-02.98	<del>ABS</del>	<b>KV 235</b>
<b>KF 133</b>	CH. --> P5077914		1.4i	60	03.92-02.98	<del>ABS</del>	<b>KV 235</b>
<b>KF 134</b>	CH. --> P*999999 / [M.T]		1.4i	60	03.92-02.98	<del>ABS</del>	<b>KV 235</b>
<b>KF 134</b>	CH. --> P*999999		1.4i	60	03.92-02.98	<del>ABS</del>	<b>KV 235</b>
<b>KF 134</b>	CH. --> P*999999		1.4i	60	03.92-02.98	<del>ABS</del>	<b>KV 235</b>
<b>KF 137</b>	CH. R*000001 -->		1.4i	60	03.92-02.98	<del>ABS</del>	<b>KV 235</b>
<b>KF 133</b>	CH. --> NE299999		1.4i	60	03.92-09.98	ABS	<b>KV 202</b>

 Fersa KIT FRONT	<b>i</b>	ENGINE	POWER (kW)	YEAR	<b>i</b>	Fersa KIT REAR 
<b>VAUXHALL</b>						
<b>ASTRA MK III</b>						
<b>KF 133</b>	CH. --> P*999999 / [A.T]	1.4i	60	03.92-09.98	ABS	<b>KV 202</b>
<b>KF 133</b>	CH. --> P5077914	1.4i	60	03.92-09.98	ABS	<b>KV 202</b>
<b>KF 134</b>	CH. --> P*999999 / [M.T]	1.4i	60	03.92-09.98	ABS	<b>KV 202</b>
<b>KF 134</b>	CH. --> P*999999	1.4i	60	03.92-09.98	ABS	<b>KV 202</b>
<b>KF 134</b>	CH. --> P*999999	1.4i	60	03.92-09.98	ABS	<b>KV 202</b>
<b>KF 137</b>	CH. R*000001 -->	1.4i	60	03.92-09.98	ABS	<b>KV 202</b>
<b>KF 133</b>	CH. --> NE299999	1.4i	60	03.92-09.98	ABS	<b>KV 235</b>
<b>KF 133</b>	CH. --> P*999999 / [A.T]	1.4i	60	03.92-09.98	ABS	<b>KV 235</b>
<b>KF 133</b>	CH. --> P5077914	1.4i	60	03.92-09.98	ABS	<b>KV 235</b>
<b>KF 134</b>	CH. --> P*999999 / [M.T]	1.4i	60	03.92-09.98	ABS	<b>KV 235</b>
<b>KF 134</b>	CH. --> P*999999	1.4i	60	03.92-09.98	ABS	<b>KV 235</b>
<b>KF 134</b>	CH. --> P*999999	1.4i	60	03.92-09.98	ABS	<b>KV 235</b>
<b>KF 137</b>	CH. R*000001 -->	1.4i	60	03.92-09.98	ABS	<b>KV 235</b>
<b>KF 133</b>	CH. --> NE299999	1.4i	60	05.93-03.01	ABS	<b>KV 202</b>
<b>KF 133</b>	CH. --> P5077914	1.4i	60	05.93-03.01	ABS	<b>KV 202</b>
<b>KF 134</b>	CH. --> RB000000	1.4i	60	05.93-03.01	ABS	<b>KV 202</b>
<b>KF 137</b>	CH. R*000001 -->	1.4i	60	05.93-03.01	ABS	<b>KV 202</b>
<b>KF 133</b>	CH. --> NE299999	1.4i	60	05.93-03.01	ABS	<b>KV 235</b>
<b>KF 133</b>	CH. --> P5077914	1.4i	60	05.93-03.01	ABS	<b>KV 235</b>
<b>KF 134</b>	CH. --> RB000000	1.4i	60	05.93-03.01	ABS	<b>KV 235</b>
<b>KF 137</b>	CH. R*000001 -->	1.4i	60	05.93-03.01	ABS	<b>KV 235</b>
<b>KF 137</b>		1.4i 16V	66	01.96-03.01	ABS	<b>KV 202</b>
<b>KF 137</b>		1.4i 16V	66	01.96-03.01	ABS	<b>KV 235</b>
<b>KF 134</b>	CH. --> RB000000	1.6i Eco	52	03.93-08.96	ABS	<b>KV 202</b>
<b>KF 137</b>	CH. R*000001 -->	1.6i Eco	52	03.93-08.96	ABS	<b>KV 202</b>
<b>KF 138</b>	CH. --> CH. W2011158 -->	1.6i Eco	52	03.93-08.96	ABS	<b>KV 202</b>
<b>KF 138</b>	CH. W5013209 -->	1.6i Eco	52	03.93-08.96	ABS	<b>KV 202</b>
<b>KF 134</b>	CH. --> RB000000	1.6i Eco	52	03.93-08.96	ABS	<b>KV 235</b>
<b>KF 137</b>	CH. R*000001 -->	1.6i Eco	52	03.93-08.96	ABS	<b>KV 235</b>
<b>KF 138</b>	CH. --> CH. W2011158 -->	1.6i Eco	52	03.93-08.96	ABS	<b>KV 235</b>
<b>KF 138</b>	CH. W5013209 -->	1.6i Eco	52	03.93-08.96	ABS	<b>KV 235</b>
<b>KF 134</b>	CH. --> P*999999 / [M.T]	1.6i	52	07.94-02.98	ABS	<b>KV 202</b>
<b>KF 134</b>	CH. --> P*999999	1.6i	52	07.94-02.98	ABS	<b>KV 202</b>
<b>KF 134</b>	CH. --> P*999999	1.6i	52	07.94-02.98	ABS	<b>KV 202</b>
<b>KF 137</b>	CH. R*000001 -->	1.6i	52	07.94-02.98	ABS	<b>KV 202</b>
<b>KF 134</b>	CH. --> P*999999 / [M.T]	1.6i	52	07.94-02.98	ABS	<b>KV 235</b>
<b>KF 134</b>	CH. --> P*999999	1.6i	52	07.94-02.98	ABS	<b>KV 235</b>
<b>KF 134</b>	CH. --> P*999999	1.6i	52	07.94-02.98	ABS	<b>KV 235</b>
<b>KF 137</b>	CH. R*000001 -->	1.6i	52	07.94-02.98	ABS	<b>KV 235</b>
<b>KF 133</b>	CH. --> NE299999	1.6i; 1.6i Eco	52-55	09.91-02.98	ABS	<b>KV 202</b>
<b>KF 133</b>	CH. --> P*999999 / [A.T]	1.6i; 1.6i Eco	52-55	09.91-02.98	ABS	<b>KV 202</b>
<b>KF 133</b>	CH. --> P5077914	1.6i; 1.6i Eco	52-55	09.91-02.98	ABS	<b>KV 202</b>
<b>KF 134</b>	CH. --> P*999999 / [M.T]	1.6i; 1.6i Eco	52-55	09.91-02.98	ABS	<b>KV 202</b>
<b>KF 134</b>	CH. --> P*999999	1.6i; 1.6i Eco	52-55	09.91-02.98	ABS	<b>KV 202</b>
<b>KF 134</b>	CH. --> P*999999	1.6i; 1.6i Eco	52-55	09.91-02.98	ABS	<b>KV 202</b>
<b>KF 137</b>	CH. R*000001 -->	1.6i; 1.6i Eco	52-55	09.91-02.98	ABS	<b>KV 202</b>
<b>KF 133</b>	CH. --> NE299999	1.6i; 1.6i Eco	52-55	09.91-02.98	ABS	<b>KV 235</b>
<b>KF 133</b>	CH. --> P*999999 / [A.T]	1.6i; 1.6i Eco	52-55	09.91-02.98	ABS	<b>KV 235</b>
<b>KF 133</b>	CH. --> P5077914	1.6i; 1.6i Eco	52-55	09.91-02.98	ABS	<b>KV 235</b>
<b>KF 134</b>	CH. --> P*999999 / [M.T]	1.6i; 1.6i Eco	52-55	09.91-02.98	ABS	<b>KV 235</b>

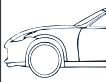
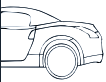
Application for passenger cars



		ENGINE	POWER (kW)	YEAR		
Fersa KIT FRONT						Fersa KIT REAR
<b>VAUXHALL</b>						
<b>ASTRA MK III</b>						
<b>KF 134</b>	CH. --> P*999999	1.6i; 1.6i Eco	52-55	09.91-02.98	<b>ABS</b>	<b>KV 235</b>
<b>KF 134</b>	CH. --> P*999999	1.6i; 1.6i Eco	52-55	09.91-02.98	<b>ABS</b>	<b>KV 235</b>
<b>KF 137</b>	CH. R*000001 -->	1.6i; 1.6i Eco	52-55	09.91-02.98	<b>ABS</b>	<b>KV 235</b>
<b>KF 133</b>	CH. --> NE299999	1.6i	55	09.91-02.98	<b>ABS</b>	<b>KV 202</b>
<b>KF 133</b>	CH. --> P*999999 / [A.T]	1.6i	55	09.91-02.98	<b>ABS</b>	<b>KV 202</b>
<b>KF 133</b>	CH. --> P5077914	1.6i	55	09.91-02.98	<b>ABS</b>	<b>KV 202</b>
<b>KF 134</b>	CH. --> P*999999 / [M.T]	1.6i	55	09.91-02.98	<b>ABS</b>	<b>KV 202</b>
<b>KF 134</b>	CH. --> P*999999	1.6i	55	09.91-02.98	<b>ABS</b>	<b>KV 202</b>
<b>KF 134</b>	CH. --> P*999999	1.6i	55	09.91-02.98	<b>ABS</b>	<b>KV 202</b>
<b>KF 137</b>	CH. R*000001 -->	1.6i	55	09.91-02.98	<b>ABS</b>	<b>KV 202</b>
<b>KF 133</b>	CH. --> NE299999	1.6i	55	09.91-02.98	<b>ABS</b>	<b>KV 235</b>
<b>KF 133</b>	CH. --> P*999999 / [A.T]	1.6i	55	09.91-02.98	<b>ABS</b>	<b>KV 235</b>
<b>KF 133</b>	CH. --> P5077914	1.6i	55	09.91-02.98	<b>ABS</b>	<b>KV 235</b>
<b>KF 134</b>	CH. --> P*999999 / [M.T]	1.6i	55	09.91-02.98	<b>ABS</b>	<b>KV 235</b>
<b>KF 134</b>	CH. --> P*999999	1.6i	55	09.91-02.98	<b>ABS</b>	<b>KV 235</b>
<b>KF 134</b>	CH. --> P*999999	1.6i	55	09.91-02.98	<b>ABS</b>	<b>KV 235</b>
<b>KF 137</b>	CH. R*000001 -->	1.6i	55	09.91-02.98	<b>ABS</b>	<b>KV 235</b>
<b>KF 133</b>	CH. --> NE299999	1.6i	55	03.92-09.98	<b>ABS</b>	<b>KV 202</b>
<b>KF 133</b>	CH. --> P*999999 / [A.T]	1.6i	55	03.92-09.98	<b>ABS</b>	<b>KV 202</b>
<b>KF 133</b>	CH. --> P5077914	1.6i	55	03.92-09.98	<b>ABS</b>	<b>KV 202</b>
<b>KF 134</b>	CH. --> P*999999 / [M.T]	1.6i	55	03.92-09.98	<b>ABS</b>	<b>KV 202</b>
<b>KF 134</b>	CH. --> P*999999	1.6i	55	03.92-09.98	<b>ABS</b>	<b>KV 202</b>
<b>KF 134</b>	CH. --> P*999999	1.6i	55	03.92-09.98	<b>ABS</b>	<b>KV 202</b>
<b>KF 137</b>	CH. R*000001 -->	1.6i	55	03.92-09.98	<b>ABS</b>	<b>KV 202</b>
<b>KF 133</b>	CH. --> NE299999	1.6i	55	03.92-09.98	<b>ABS</b>	<b>KV 235</b>
<b>KF 133</b>	CH. --> P*999999 / [A.T]	1.6i	55	03.92-09.98	<b>ABS</b>	<b>KV 235</b>
<b>KF 133</b>	CH. --> P5077914	1.6i	55	03.92-09.98	<b>ABS</b>	<b>KV 235</b>
<b>KF 134</b>	CH. --> P*999999 / [M.T]	1.6i	55	03.92-09.98	<b>ABS</b>	<b>KV 235</b>
<b>KF 134</b>	CH. --> P*999999	1.6i	55	03.92-09.98	<b>ABS</b>	<b>KV 235</b>
<b>KF 134</b>	CH. --> P*999999	1.6i	55	03.92-09.98	<b>ABS</b>	<b>KV 235</b>
<b>KF 137</b>	CH. R*000001 -->	1.6i	55	03.92-09.98	<b>ABS</b>	<b>KV 235</b>
<b>KF 137</b>	CH. R*000001 -->	1.6i	55	01.96-03.01	<b>ABS</b>	<b>KV 202</b>
<b>KF 134</b>	CH. W2011158 -->	1.6i	55	01.96-03.01	<b>ABS</b>	<b>KV 202</b>
<b>KF 138</b>	CH. W5013209 -->	1.6i	55	01.96-03.01	<b>ABS</b>	<b>KV 202</b>
<b>KF 137</b>	CH. R*000001 -->	1.6i	55	01.96-03.01	<b>ABS</b>	<b>KV 235</b>
<b>KF 134</b>	CH. W2011158 -->	1.6i	55	01.96-03.01	<b>ABS</b>	<b>KV 235</b>
<b>KF 138</b>	CH. W5013209 -->	1.6i	55	01.96-03.01	<b>ABS</b>	<b>KV 235</b>
<b>KF 133</b>	CH. --> NE299999	1.6 Si	74	03.91-12.94	<b>ABS</b>	<b>KV 202</b>
<b>KF 133</b>	CH. --> P*999999 / [A.T]	1.6 Si	74	03.91-12.94	<b>ABS</b>	<b>KV 202</b>
<b>KF 133</b>	CH. --> P5077914	1.6 Si	74	03.91-12.94	<b>ABS</b>	<b>KV 202</b>
<b>KF 134</b>	CH. --> P*999999 / [M.T]	1.6 Si	74	03.91-12.94	<b>ABS</b>	<b>KV 202</b>
<b>KF 134</b>	CH. --> P*999999	1.6 Si	74	03.91-12.94	<b>ABS</b>	<b>KV 202</b>
<b>KF 134</b>	CH. --> P*999999	1.6 Si	74	03.91-12.94	<b>ABS</b>	<b>KV 202</b>
<b>KF 137</b>	CH. R*000001 -->	1.6 Si	74	03.91-12.94	<b>ABS</b>	<b>KV 202</b>
<b>KF 133</b>	CH. --> NE299999	1.6 Si	74	03.91-12.94	<b>ABS</b>	<b>KV 235</b>
<b>KF 133</b>	CH. --> P*999999 / [A.T]	1.6 Si	74	03.91-12.94	<b>ABS</b>	<b>KV 235</b>
<b>KF 133</b>	CH. --> P5077914	1.6 Si	74	03.91-12.94	<b>ABS</b>	<b>KV 235</b>
<b>KF 134</b>	CH. --> P*999999 / [M.T]	1.6 Si	74	03.91-12.94	<b>ABS</b>	<b>KV 235</b>
<b>KF 134</b>	CH. --> P*999999	1.6 Si	74	03.91-12.94	<b>ABS</b>	<b>KV 235</b>
<b>KF 134</b>	CH. --> P*999999	1.6 Si	74	03.91-12.94	<b>ABS</b>	<b>KV 235</b>

	<b>i</b>	<b>ENGINE</b>	<b>POWER (kW)</b>	<b>YEAR</b>	<b>i</b>	
Fersa KIT FRONT						Fersa KIT REAR
<b>VAUXHALL</b>						
<b>ASTRA MK III</b>						
<b>KF 137</b>	CH. R*000001 -->	1.6 Si	74	03.91-12.94	<del>ABS</del>	<b>KV 235</b>
<b>KF 133</b>	CH. --> NE299999	1.6i	74	03.92-02.98	ABS	<b>KV 202</b>
<b>KF 133</b>	CH. --> P*999999 / [A.T]	1.6i	74	03.92-02.98	ABS	<b>KV 202</b>
<b>KF 133</b>	CH. --> P5077914	1.6i	74	03.92-02.98	ABS	<b>KV 202</b>
<b>KF 134</b>	CH. --> P*999999 / [M.T]	1.6i	74	03.92-02.98	ABS	<b>KV 202</b>
<b>KF 134</b>	CH. --> P*999999	1.6i	74	03.92-02.98	ABS	<b>KV 202</b>
<b>KF 134</b>	CH. --> P*999999	1.6i	74	03.92-02.98	ABS	<b>KV 202</b>
<b>KF 137</b>	CH. R*000001 -->	1.6i	74	03.92-02.98	ABS	<b>KV 202</b>
<b>KF 133</b>	CH. --> NE299999	1.6i	74	03.92-02.98	<del>ABS</del>	<b>KV 235</b>
<b>KF 133</b>	CH. --> P*999999 / [A.T]	1.6i	74	03.92-02.98	<del>ABS</del>	<b>KV 235</b>
<b>KF 133</b>	CH. --> P5077914	1.6i	74	03.92-02.98	<del>ABS</del>	<b>KV 235</b>
<b>KF 134</b>	CH. --> P*999999 / [M.T]	1.6i	74	03.92-02.98	<del>ABS</del>	<b>KV 235</b>
<b>KF 134</b>	CH. --> P*999999	1.6i	74	03.92-02.98	<del>ABS</del>	<b>KV 235</b>
<b>KF 134</b>	CH. --> P*999999	1.6i	74	03.92-02.98	<del>ABS</del>	<b>KV 235</b>
<b>KF 137</b>	CH. R*000001 -->	1.6i	74	03.92-02.98	<del>ABS</del>	<b>KV 235</b>
<b>KF 137</b>	ABS / [A.T]	1.6i 16V	74	01.94-02.98	ABS	<b>KV 202</b>
<b>KF 137</b>	ABS / CH. --> W2011157	1.6i 16V	74	01.94-02.98	ABS	<b>KV 202</b>
<b>KF 137</b>	ABS / CH. --> W5013208	1.6i 16V	74	01.94-02.98	ABS	<b>KV 202</b>
<b>KF 138</b>	CH. --> CH. W2011158 --> / [M.T],	1.6i 16V	74	01.94-02.98	ABS	<b>KV 202</b>
<b>KF 138</b>	CH. W5013209 --> / [M.T],	1.6i 16V	74	01.94-02.98	ABS	<b>KV 202</b>
<b>KF 137</b>	ABS / [A.T]	1.6i 16V	74	01.94-02.98	<del>ABS</del>	<b>KV 235</b>
<b>KF 137</b>	ABS / CH. --> W2011157	1.6i 16V	74	01.94-02.98	<del>ABS</del>	<b>KV 235</b>
<b>KF 137</b>	ABS / CH. --> W5013208	1.6i 16V	74	01.94-02.98	<del>ABS</del>	<b>KV 235</b>
<b>KF 138</b>	CH. --> CH. W2011158 --> / [M.T]	1.6i 16V	74	01.94-02.98	<del>ABS</del>	<b>KV 235</b>
<b>KF 138</b>	CH. W5013209 --> / [M.T]	1.6i 16V	74	01.94-02.98	<del>ABS</del>	<b>KV 235</b>
<b>KF 137</b>		1.6i 16V	74	08.94-09.98	ABS	<b>KV 202</b>
<b>KF 138</b>	CH. --> CH. W2011158 --> / [M.T]	1.6i 16V	74	08.94-09.98	ABS	<b>KV 202</b>
<b>KF 138</b>	CH. W5013209 --> / [M.T]	1.6i 16V	74	08.94-09.98	ABS	<b>KV 202</b>
<b>KF 137</b>		1.6i 16V	74	08.94-09.98	<del>ABS</del>	<b>KV 235</b>
<b>KF 138</b>	CH. --> CH. W2011158 --> / [M.T]	1.6i 16V	74	08.94-09.98	<del>ABS</del>	<b>KV 235</b>
<b>KF 138</b>	CH. W5013209 --> / [M.T]	1.6i 16V	74	08.94-09.98	<del>ABS</del>	<b>KV 235</b>
<b>KF 134</b>	CH. --> S*999999	1.8i	66	09.91-02.98	ABS	<b>KV 202</b>
<b>KF 138</b>	CH. T*000001 -->	1.8i	66	09.91-02.98	ABS	<b>KV 202</b>
<b>KF 138</b>	CH. T2500001 -->	1.8i	66	09.91-02.98	ABS	<b>KV 202</b>
<b>KF 134</b>	CH. --> S*999999	1.8i	66	09.91-02.98	<del>ABS</del>	<b>KV 235</b>
<b>KF 138</b>	CH. T*000001 -->	1.8i	66	09.91-02.98	<del>ABS</del>	<b>KV 235</b>
<b>KF 138</b>	CH. T2500001 -->	1.8i	66	09.91-02.98	ABS	<b>KV 235</b>
<b>KF 134</b>	CH. --> S*999999	1.8i; 1.8i 16V	66-85	09.91-09.98	ABS	<b>KV 202</b>
<b>KF 138</b>	CH. T*000001 -->	1.8i; 1.8i 16V	66-85	09.91-09.98	ABS	<b>KV 202</b>
<b>KF 138</b>	CH. T2500001 -->	1.8i; 1.8i 16V	66-85	09.91-09.98	ABS	<b>KV 202</b>
<b>KF 134</b>	CH. --> S*999999	1.8i; 1.8i 16V	66-85	09.91-09.98	<del>ABS</del>	<b>KV 235</b>
<b>KF 138</b>	CH. T*000001 -->	1.8i; 1.8i 16V	66-85	09.91-09.98	<del>ABS</del>	<b>KV 235</b>
<b>KF 138</b>	CH. T2500001 -->	1.8i; 1.8i 16V	66-85	09.91-09.98	<del>ABS</del>	<b>KV 235</b>
<b>KF 138</b>		1.8i; 1.8i 16V	66-85	09.91-09.98		
<b>KF 134</b>	CH. --> S*999999	1.8i 16V	85	09.94-02.98	ABS	<b>KV 202</b>
<b>KF 138</b>	CH. T*000001 -->	1.8i 16V	85	09.94-02.98	ABS	<b>KV 202</b>
<b>KF 138</b>	CH. T2500001 -->	1.8i 16V	85	09.94-02.98	ABS	<b>KV 202</b>

		ENGINE	POWER (kW)	YEAR		
Fersa KIT FRONT						Fersa KIT REAR
<b>VAUXHALL</b>						
<b>ASTRA MK III</b>						
<b>KF 134</b>	CH. --> S*999999	1.8i 16V	85	09.94-02.98	<b>ABS</b>	<b>KV 235</b>
<b>KF 138</b>	CH. T*000001 -->	1.8i 16V	85	09.94-02.98	<b>ABS</b>	<b>KV 235</b>
<b>KF 138</b>	CH. T2500001 -->	1.8i 16V	85	09.94-02.98	<b>ABS</b>	<b>KV 235</b>
<b>KF 138</b>	CH. T*000001 -->	1.8i 16V	85	09.94-02.98	<b>ABS</b>	<b>KV 202</b>
<b>KF 138</b>	CH. T2500001 -->	1.8i 16V	85	09.94-02.98	<b>ABS</b>	<b>KV 202</b>
<b>KF 138</b>	CH. T*000001 -->	1.8i 16V	92	09.94-02.98	<b>ABS</b>	<b>KV 202</b>
<b>KF 138</b>	CH. T2500001 -->	1.8i 16V	92	09.94-02.98	<b>ABS</b>	<b>KV 202</b>
<b>KF 138</b>	CH. T*000001 -->	1.8i 16V	85	09.94-02.98	<b>ABS</b>	<b>KV 235</b>
<b>KF 138</b>	CH. T2500001 -->	1.8i 16V	85	09.94-02.98	<b>ABS</b>	<b>KV 235</b>
<b>KF 138</b>	CH. T*000001 -->	1.8i 16V	92	09.94-02.98	<b>ABS</b>	<b>KV 235</b>
<b>KF 138</b>	CH. T2500001 -->	1.8i 16V	92	09.94-02.98	<b>ABS</b>	<b>KV 235</b>
<b>KF 134</b>	CH. --> S*999999	1.8 16V; 1.8i 16V; 2.0i	85-92	09.91-03.01	<b>ABS</b>	<b>KV 202</b>
<b>KF 138</b>	CH. T*000001 -->	1.8 16V; 1.8i 16V; 2.0i	85-92	09.91-03.01	<b>ABS</b>	<b>KV 202</b>
<b>KF 138</b>	T2500001	1.8 16V; 1.8i 16V; 2.0i	85-92	09.91-03.01	<b>ABS</b>	<b>KV 202</b>
<b>KF 134</b>	CH. --> S*999999	1.8 16V; 1.8i 16V; 2.0i	85-92	09.91-03.01	<b>ABS</b>	<b>KV 235</b>
<b>KF 138</b>	CH. T*000001 -->	1.8 16V; 1.8i 16V; 2.0i	85-92	09.91-03.01	<b>ABS</b>	<b>KV 235</b>
<b>KF 138</b>	T2500001	1.8 16V; 1.8i 16V; 2.0i	85-92	09.91-03.01	<b>ABS</b>	<b>KV 235</b>
<b>KF 134</b>	CH. --> S*999999	2.0i	85	09.91-02.98	<b>ABS</b>	<b>KV 202</b>
<b>KF 138</b>	CH. T*000001 -->	2.0i	85	09.91-02.98	<b>ABS</b>	<b>KV 202</b>
<b>KF 138</b>	CH. T2500001 -->	2.0i	85	09.91-02.98	<b>ABS</b>	<b>KV 202</b>
<b>KF 134</b>	CH. --> S*999999	2.0i	85	09.91-02.98	<b>ABS</b>	<b>KV 235</b>
<b>KF 138</b>	CH. T*000001 -->	2.0i	85	09.91-02.98	<b>ABS</b>	<b>KV 235</b>
<b>KF 138</b>	CH. T2500001 -->	2.0i	85	09.91-02.98	<b>ABS</b>	<b>KV 235</b>
<b>KF 134</b>	CH. --> S*999999	2.0i; 2.0i 16V	85-110	09.91-09.98	<b>ABS</b>	<b>KV 202</b>
<b>KF 138</b>	CH. T*000001 -->	2.0i; 2.0i 16V	85-110	09.91-09.98	<b>ABS</b>	<b>KV 202</b>
<b>KF 138</b>	CH. T2500001 -->	2.0i; 2.0i 16V	85-110	09.91-09.98	<b>ABS</b>	<b>KV 202</b>
<b>KF 134</b>	CH. --> S*999999	2.0i; 2.0i 16V	85-110	09.91-09.98	<b>ABS</b>	<b>KV 235</b>
<b>KF 138</b>	CH. T*000001 -->	2.0i; 2.0i 16V	85-110	09.91-09.98	<b>ABS</b>	<b>KV 235</b>
<b>KF 138</b>	CH. T2500001 -->	2.0i; 2.0i 16V	85-110	09.91-09.98	<b>ABS</b>	<b>KV 235</b>
<b>KF 134</b>	CH. --> S*999999	1.7 TD	60	12.91-02.98	<b>ABS</b>	<b>KV 202</b>
<b>KF 138</b>	CH. T*000001 -->	1.7 TD	60	12.91-02.98	<b>ABS</b>	<b>KV 202</b>
<b>KF 138</b>	CH. T2500001 -->	1.7 TD	60	12.91-02.98	<b>ABS</b>	<b>KV 202</b>
<b>KF 134</b>	CH. --> S*999999	1.7 TD	60	12.91-02.98	<b>ABS</b>	<b>KV 235</b>
<b>KF 138</b>	CH. T*000001 -->	1.7 TD	60	12.91-02.98	<b>ABS</b>	<b>KV 235</b>
<b>KF 138</b>	CH. T2500001 -->	1.7 TD	60	12.91-02.98	<b>ABS</b>	<b>KV 235</b>
		1.7 TD	60	12.91-02.98	<b>ABS</b>	<b>KV 202</b>
<b>KF 138</b>	CH. T*000001 -->	1.7 TD	60	12.91-02.98	<b>ABS</b>	<b>KV 202</b>
<b>KF 138</b>	CH. T2500001 -->	1.7 TD	60	12.91-02.98	<b>ABS</b>	<b>KV 202</b>
<b>KF 138</b>	CH. T*000001 -->	1.7 D	42	12.91-02.98	<b>ABS</b>	<b>KV 202</b>
<b>KF 138</b>	CH. T2500001 -->	1.7 D	42	12.91-02.98	<b>ABS</b>	<b>KV 202</b>
<b>KF 138</b>	CH. T*000001 -->	1.7 TD	60	12.91-02.98	<b>ABS</b>	<b>KV 235</b>
<b>KF 138</b>	CH. T2500001 -->	1.7 TD	60	12.91-02.98	<b>ABS</b>	<b>KV 235</b>
<b>KF 138</b>	CH. T*000001 -->	1.7 D	42	12.91-02.98	<b>ABS</b>	<b>KV 235</b>
<b>KF 138</b>	CH. T2500001 -->	1.7 D	42	12.91-02.98	<b>ABS</b>	<b>KV 235</b>
<b>KF 134</b>	CH. --> S*999999	1.7 D	42-44	03.91-02.98	<b>ABS</b>	<b>KV 202</b>
<b>KF 138</b>	CH. T*000001 -->	1.7 D	42-44	03.91-02.98	<b>ABS</b>	<b>KV 202</b>
<b>KF 138</b>	CH. T2500001 -->	1.7 D	42-44	03.91-02.98	<b>ABS</b>	<b>KV 202</b>
<b>KF 134</b>	CH. --> S*999999	1.7 D	42-44	03.91-02.98	<b>ABS</b>	<b>KV 235</b>
<b>KF 138</b>	CH. T*000001 -->	1.7 D	42-44	03.91-02.98	<b>ABS</b>	<b>KV 235</b>
<b>KF 138</b>	CH. T2500001 -->	1.7 D	42-44	03.91-02.98	<b>ABS</b>	<b>KV 235</b>



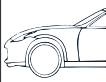
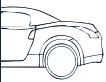

Fersa KIT FRONT		ENGINE			POWER (kW)	YEAR	Fersa KIT REAR	
<b>VAUXHALL</b>								
<b>ASTRA MK III</b>								
<b>KF 134</b>	CH. --> S*999999	1.7 D			44	09.91-12.94	ABS	<b>KV 202</b>
<b>KF 138</b>	CH. T*000001 -->	1.7 D			44	09.91-12.94	ABS	<b>KV 202</b>
<b>KF 138</b>	CH. T2500001 -->	1.7 D			44	09.91-12.94	ABS	<b>KV 202</b>
<b>KF 134</b>	CH. --> S*999999	1.7 D			44	09.91-12.94	ABS	<b>KV 235</b>
<b>KF 138</b>	CH. T*000001 -->	1.7 D			44	09.91-12.94	ABS	<b>KV 235</b>
<b>KF 138</b>	CH. T2500001 -->	1.7 D			44	09.91-12.94	ABS	<b>KV 235</b>
<b>KF 134</b>	CH. --> S*999999	1.7 D; 1.7 TD			42-50	03.92-09.98	ABS	<b>KV 202</b>
<b>KF 138</b>	CH. T*000001 -->	1.7 D; 1.7 TD			42-50	03.92-09.98	ABS	<b>KV 202</b>
<b>KF 138</b>	CH. T2500001 -->	1.7 D; 1.7 TD			42-50	03.92-09.98	ABS	<b>KV 202</b>
<b>KF 134</b>	CH. --> S*999999	1.7 D; 1.7 TD			42-50	03.92-09.98	ABS	<b>KV 235</b>
<b>KF 138</b>	CH. T*000001 -->	1.7 D; 1.7 TD			42-50	03.92-09.98	ABS	<b>KV 235</b>
<b>KF 138</b>	CH. T2500001 -->	1.7 D; 1.7 TD			42-50	03.92-09.98	ABS	<b>KV 235</b>
<b>ASTRA MK IV</b>								
<b>KV 199</b>	ABS	1.2 16V; 1.4 16V; 1.6; 1.6 16V; 1.6 Duafuel; 1.8 16V; 1.8 16V Duafuel; 2.0 16V; 2.0 16V TURBO; 2.0 TURBO; 2.2 16V			48-141	02.98-	ABS	<b>KV 202</b>
<b>KV 198</b>	ABS	1.2 16V; 1.4 16V; 1.6; 1.6 16V; 1.6 Duafuel; 1.8 16V; 1.8 16V Duafuel; 2.0 16V; 2.0 16V TURBO; 2.0 TURBO; 2.2 16V			48-141	02.98-	ABS	<b>KV 252</b>
<b>KV 247</b>	ABS	1.2 16V; 1.4 16V; 1.6; 1.6 16V; 1.6 Duafuel; 1.8 16V; 1.8 16V Duafuel; 2.0 16V; 2.0 16V TURBO; 2.0 TURBO; 2.2 16V			48-141	02.98-	ABS	<b>KV 235</b>
<b>KV 196</b>	ABS	1.2 16V; 1.4 16V; 1.6; 1.6 16V; 1.6 Duafuel; 1.8 16V; 1.8 16V Duafuel; 2.0 16V; 2.0 16V TURBO; 2.0 TURBO; 2.2 16V			48-141	02.98-	ABS	<b>KV 279</b>
<b>KV 199</b>	ABS	1.2 16V; 1.4 16V; 1.6; 1.6 16V; 1.6 Duafuel; 1.8 16V; 1.8 16V Duafuel; 2.0 16V; 2.0 16V TURBO; 2.0 TURBO; 2.2 16V			48-141	02.98-	ABS	<b>KV 252</b>
<b>KV 198</b>	ABS	1.2 16V; 1.4 16V; 1.6; 1.6 16V; 1.6 Duafuel; 1.8 16V; 1.8 16V Duafuel; 2.0 16V; 2.0 16V TURBO; 2.0 TURBO; 2.2 16V			48-141	02.98-	ABS	<b>KV 202</b>
<b>KV 247</b>	ABS	1.2 16V; 1.4 16V; 1.6; 1.6 16V; 1.6 Duafuel; 1.8 16V; 1.8 16V Duafuel; 2.0 16V; 2.0 16V TURBO; 2.0 TURBO; 2.2 16V			48-141	02.98-	ABS	<b>KV 279</b>
<b>KV 196</b>	ABS	1.2 16V; 1.4 16V; 1.6; 1.6 16V; 1.6 Duafuel; 1.8 16V; 1.8 16V Duafuel; 2.0 16V; 2.0 16V TURBO; 2.0 TURBO; 2.2 16V			48-141	02.98-	ABS	<b>KV 235</b>
<b>KV 199</b>	ABS	1.7 CDTI 16V; 1.7 DTI 16V; 1.7 TD; 2.0 DI; 2.0 DTI 16V			50-74	02.98-	ABS	<b>KV 202</b>
<b>KV 198</b>	ABS	1.7 CDTI 16V; 1.7 DTI 16V; 1.7 TD; 2.0 DI; 2.0 DTI 16V			50-74	02.98-	ABS	<b>KV 252</b>
<b>KV 247</b>	ABS	1.7 CDTI 16V; 1.7 DTI 16V; 1.7 TD; 2.0 DI; 2.0 DTI 16V			50-74	02.98-	ABS	<b>KV 235</b>
<b>KV 196</b>	ABS	1.7 CDTI 16V; 1.7 DTI 16V; 1.7 TD; 2.0 DI; 2.0 DTI 16V			50-74	02.98-	ABS	<b>KV 279</b>
<b>KV 199</b>	ABS	1.7 CDTI 16V; 1.7 DTI 16V; 1.7 TD; 2.0 DI; 2.0 DTI 16V			50-74	02.98-	ABS	<b>KV 252</b>
<b>KV 198</b>	ABS	1.7 CDTI 16V; 1.7 DTI 16V; 1.7 TD; 2.0 DI; 2.0 DTI 16V			50-74	02.98-	ABS	<b>KV 202</b>
<b>KV 247</b>	ABS	1.7 CDTI 16V; 1.7 DTI 16V; 1.7 TD; 2.0 DI; 2.0 DTI 16V			50-74	02.98-	ABS	<b>KV 279</b>
<b>KV 196</b>	ABS	1.7 CDTI 16V; 1.7 DTI 16V; 1.7 TD; 2.0 DI; 2.0 DTI 16V			50-74	02.98-	ABS	<b>KV 235</b>
<b>ASTRA MK V CC</b>								
<b>KV 333</b>		1.4; 1.6; 1.8			66-92	03.04-		<b>KV 330</b>
<b>KV 332</b>		1.4; 1.6; 1.8			66-92	03.04-		<b>KV 331</b>
<b>KV 332</b>		1.4; 1.6; 1.8			66-92	03.04-		<b>KV 330</b>
<b>KV 333</b>		1.4; 1.6; 1.8			66-92	03.04-		<b>KV 331</b>
<b>KV 333</b>		2.0 Turbo			125-147	03.04-		<b>KV 330</b>
<b>KV 332</b>	CH. --> 62079978	2.0 Turbo			125-147	03.04-		<b>KV 330</b>
<b>KV 332</b>	CH. --> 65076709	2.0 Turbo			125-147	03.04-		<b>KV 330</b>
<b>KV 332</b>	CH. --> 68027072	2.0 Turbo			125-147	03.04-		<b>KV 330</b>
<b>KV 333</b>		2.0 Turbo			125-147	03.04-		<b>KV 331</b>
<b>KV 332</b>	CH. --> 62079978	2.0 Turbo			125-147	03.04-		<b>KV 331</b>
<b>KV 332</b>	CH. --> 65076709	2.0 Turbo			125-147	03.04-		<b>KV 331</b>
<b>KV 332</b>	CH. --> 68027072	2.0 Turbo			125-147	03.04-		<b>KV 331</b>
<b>KV 333</b>		2.0 Turbo			177	03.05-		<b>KV 330</b>
<b>KV 333</b>		2.0 Turbo			177	03.05-		<b>KV 331</b>
<b>KV 333</b>		1.3 CDTI; 1.7 CDTI			59-74	03.04-		<b>KV 330</b>

	<b>i</b>	<b>ENGINE</b>	<b>POWER (kW)</b>	<b>YEAR</b>	<b>i</b>	
Fersa KIT FRONT						Fersa KIT REAR
<b>VAUXHALL</b>						
<b>ASTRA MK V CC</b>						
<b>KV 332</b>		1.3 CDTI; 1.7 CDTI	59-74	03.04-		<b>KV 331</b>
<b>KV 332</b>		1.3 CDTI; 1.7 CDTI	59-74	03.04-		<b>KV 330</b>
<b>KV 333</b>		1.3 CDTI; 1.7 CDTI	59-74	03.04-		<b>KV 331</b>
<b>KV 333</b>		1.9 CDTI; 1.9 CDTI 16V	88	04.04-		<b>KV 330</b>
<b>KV 332</b>	CH. --> 62079978	1.9 CDTI; 1.9 CDTI 16V	88	04.04-		<b>KV 330</b>
<b>KV 332</b>	CH. --> 65076709	1.9 CDTI; 1.9 CDTI 16V	88	04.04-		<b>KV 330</b>
<b>KV 332</b>	CH. --> 68027072	1.9 CDTI; 1.9 CDTI 16V	88	04.04-		<b>KV 330</b>
<b>KV 333</b>		1.9 CDTI; 1.9 CDTI 16V	88	04.04-		<b>KV 331</b>
<b>KV 332</b>	CH. --> 62079978	1.9 CDTI; 1.9 CDTI 16V	88	04.04-		<b>KV 331</b>
<b>KV 332</b>	CH. --> 65076709	1.9 CDTI; 1.9 CDTI 16V	88	04.04-		<b>KV 331</b>
<b>KV 332</b>	CH. --> 68027072	1.9 CDTI; 1.9 CDTI 16V	88	04.04-		<b>KV 331</b>
<b>KV 333</b>		1.9 CDTI	110	06.04-		<b>KV 330</b>
<b>KV 333</b>		1.9 CDTI	110	06.04-		<b>KV 331</b>
<b>ASTRA MK V ESTATE</b>						
<b>KV 333</b>		1.4; 1.6; 1.8	66-92	08.04-		<b>KV 330</b>
<b>KV 332</b>		1.4; 1.6; 1.8	66-92	08.04-		<b>KV 331</b>
<b>KV 332</b>		1.4; 1.6; 1.8	66-92	08.04-		<b>KV 330</b>
<b>KV 333</b>		1.4; 1.6; 1.8	66-92	08.04-		<b>KV 331</b>
<b>KV 333</b>		2.0 Turbo	125-147	08.04-		<b>KV 330</b>
<b>KV 332</b>	CH. --> 62079978	2.0 Turbo	125-147	08.04-		<b>KV 330</b>
<b>KV 332</b>	CH. --> 65076709	2.0 Turbo	125-147	08.04-		<b>KV 330</b>
<b>KV 332</b>	CH. --> 68027072	2.0 Turbo	125-147	08.04-		<b>KV 330</b>
<b>KV 333</b>		2.0 Turbo	125-147	08.04-		<b>KV 331</b>
<b>KV 332</b>	CH. --> 62079978	2.0 Turbo	125-147	08.04-		<b>KV 331</b>
<b>KV 332</b>	CH. --> 65076709	2.0 Turbo	125-147	08.04-		<b>KV 331</b>
<b>KV 332</b>	CH. --> 68027072	2.0 Turbo	125-147	08.04-		<b>KV 331</b>
<b>KV 333</b>		1.3 CDTI; 1.7 CDTI	66-74	08.04-		<b>KV 330</b>
<b>KV 332</b>		1.3 CDTI; 1.7 CDTI	66-74	08.04-		<b>KV 331</b>
<b>KV 332</b>		1.3 CDTI; 1.7 CDTI	66-74	08.04-		<b>KV 330</b>
<b>KV 333</b>		1.3 CDTI; 1.7 CDTI	66-74	08.04-		<b>KV 331</b>
<b>KV 333</b>		1.9 CDTI; 1.9 CDTI 16V	88	08.04-		<b>KV 330</b>
<b>KV 332</b>	CH. --> 62079978	1.9 CDTI; 1.9 CDTI 16V	88	08.04-		<b>KV 330</b>
<b>KV 332</b>	CH. --> 65076709	1.9 CDTI; 1.9 CDTI 16V	88	08.04-		<b>KV 330</b>
<b>KV 332</b>	CH. --> 68027072	1.9 CDTI; 1.9 CDTI 16V	88	08.04-		<b>KV 330</b>
<b>KV 333</b>		1.9 CDTI; 1.9 CDTI 16V	88	08.04-		<b>KV 331</b>
<b>KV 332</b>	CH. --> 62079978	1.9 CDTI; 1.9 CDTI 16V	88	08.04-		<b>KV 331</b>
<b>KV 332</b>	CH. --> 65076709	1.9 CDTI; 1.9 CDTI 16V	88	08.04-		<b>KV 331</b>
<b>KV 332</b>	CH. --> 68027072	1.9 CDTI; 1.9 CDTI 16V	88	08.04-		<b>KV 331</b>
<b>KV 333</b>		1.9 CDTI	110	08.04-		<b>KV 330</b>
<b>KV 333</b>		1.9 CDTI	110	08.04-		<b>KV 331</b>
<b>ASTRA MK V SPORT HATCH</b>						
<b>KV 333</b>		1.6; 1.8	77-92	02.05-		<b>KV 330</b>
<b>KV 332</b>		1.6; 1.8	77-92	02.05-		<b>KV 331</b>
<b>KV 332</b>		1.6; 1.8	77-92	02.05-		<b>KV 330</b>
<b>KV 333</b>		1.6; 1.8	77-92	02.05-		<b>KV 331</b>
<b>KV 333</b>		2.0 Turbo	125	02.05-		<b>KV 330</b>
<b>KV 332</b>	CH. --> 62079978	2.0 Turbo	125	02.05-		<b>KV 330</b>
<b>KV 332</b>	CH. --> 65076709	2.0 Turbo	125	02.05-		<b>KV 330</b>
<b>KV 332</b>	CH. --> 68027072	2.0 Turbo	125	02.05-		<b>KV 330</b>
<b>KV 333</b>		2.0 Turbo	125	02.05-		<b>KV 331</b>

	<b>i</b>	<b>ENGINE</b>	<b>POWER (kW)</b>	<b>YEAR</b>	<b>i</b>	
Fersa KIT FRONT						Fersa KIT REAR
<b>VAUXHALL</b>						
<b>ASTRA MK V SPORT HATCH</b>						
<b>KV 332</b>	CH. --> 62079978	2.0 Turbo	125	02.05-		<b>KV 331</b>
<b>KV 332</b>	CH. --> 65076709	2.0 Turbo	125	02.05-		<b>KV 331</b>
<b>KV 332</b>	CH. --> 68027072	2.0 Turbo	125	02.05-		<b>KV 331</b>
<b>KV 333</b>		1.7 CDTi	74	02.05-		<b>KV 330</b>
<b>KV 332</b>		1.7 CDTi	74	02.05-		<b>KV 331</b>
<b>KV 332</b>		1.7 CDTi	74	02.05-		<b>KV 330</b>
<b>KV 333</b>		1.7 CDTi	74	02.05-		<b>KV 331</b>
<b>KV 333</b>		1.9 CDTi	88	02.05-		<b>KV 330</b>
<b>KV 332</b>	CH. --> 62079978	1.9 CDTi	88	02.05-		<b>KV 330</b>
<b>KV 332</b>	CH. --> 65076709	1.9 CDTi	88	02.05-		<b>KV 330</b>
<b>KV 332</b>	CH. --> 68027072	1.9 CDTi	88	02.05-		<b>KV 330</b>
<b>KV 333</b>		1.9 CDTi	88	02.05-		<b>KV 331</b>
<b>KV 332</b>	CH. --> 62079978	1.9 CDTi	88	02.05-		<b>KV 331</b>
<b>KV 332</b>	CH. --> 65076709	1.9 CDTi	88	02.05-		<b>KV 331</b>
<b>KV 332</b>	CH. --> 68027072	1.9 CDTi	88	02.05-		<b>KV 331</b>
<b>KV 333</b>		1.9 CDTi	110	02.05-		<b>KV 330</b>
<b>KV 333</b>		1.9 CDTi	110	02.05-		<b>KV 331</b>
<b>ASTRA TWINTOP</b>						
<b>KV 333</b>		1.6	77	09.05-		<b>KV 330</b>
<b>KV 332</b>		1.6	77	09.05-		<b>KV 331</b>
<b>KV 332</b>		1.6	77	09.05-		<b>KV 330</b>
<b>KV 333</b>		1.6	77	09.05-		<b>KV 331</b>
<b>ASTRAVAN MK IV</b>						
<b>KV 199</b>	ABS	1.6i	55-62	08.98-	ABS	<b>KV 202</b>
<b>KV 198</b>	ABS	1.6i	55-62	08.98-	ABS	<b>KV 252</b>
<b>KV 247</b>	ABS	1.6i	55-62	08.98-	ABS	<b>KV 235</b>
<b>KV 196</b>	ABS	1.6i	55-62	08.98-	ABS	<b>KV 279</b>
<b>KV 199</b>	ABS	1.6i	55-62	08.98-	ABS	<b>KV 252</b>
<b>KV 198</b>	ABS	1.6i	55-62	08.98-	ABS	<b>KV 202</b>
<b>KV 247</b>	ABS	1.6i	55-62	08.98-	ABS	<b>KV 279</b>
<b>KV 196</b>	ABS	1.6i	55-62	08.98-	ABS	<b>KV 235</b>
<b>KV 199</b>	ABS	1.7 CDTi; 1.7 TD; 2.0 Di; 2.0 DTi	50-74	08.98-	ABS	<b>KV 202</b>
<b>KV 198</b>	ABS	1.7 CDTi; 1.7 TD; 2.0 Di; 2.0 DTi	50-74	08.98-	ABS	<b>KV 252</b>
<b>KV 247</b>	ABS	1.7 CDTi; 1.7 TD; 2.0 Di; 2.0 DTi	50-74	08.98-	ABS	<b>KV 235</b>
<b>KV 196</b>	ABS	1.7 CDTi; 1.7 TD; 2.0 Di; 2.0 DTi	50-74	08.98-	ABS	<b>KV 279</b>
<b>KV 199</b>	ABS	1.7 CDTi; 1.7 TD; 2.0 Di; 2.0 DTi	50-74	08.98-	ABS	<b>KV 252</b>
<b>KV 198</b>	ABS	1.7 CDTi; 1.7 TD; 2.0 Di; 2.0 DTi	50-74	08.98-	ABS	<b>KV 202</b>
<b>KV 247</b>	ABS	1.7 CDTi; 1.7 TD; 2.0 Di; 2.0 DTi	50-74	08.98-	ABS	<b>KV 279</b>
<b>KV 196</b>	ABS	1.7 CDTi; 1.7 TD; 2.0 Di; 2.0 DTi	50-74	08.98-	ABS	<b>KV 235</b>
<b>BELMONT</b>						
<b>KF 134</b>		1.6D-1.6DA-1.6S-1.8-2.0	55-62	86-91		<b>KA 038</b>
<b>CALIBRA</b>						
<b>KF 134</b>		2.0i; 2.0i 16V	85-100	06.90-07.97		<b>KF 136</b>
<b>KF 136</b>		2.0i 16V	110	06.90-02.94		<b>KA 007</b>
<b>KF 134</b>		2.0i 16V 4x4; 2.0i 4x4; 2.0i TURBO 4x4; 2.5i V6	85-150	06.90-07.97		<b>KF 136</b>
<b>CARLTON MK II</b>						
<b>KA 007</b>		1.8 S Limousine	65	12.82-08.86		
<b>KA 007</b>		1.8 S Estate Car	66	11.82-08.86		
<b>KA 007</b>		2.0i Limousine	81	01.83-12.84		
<b>KA 007</b>	[M.T.]	2.0 S Limousine	74	10.78-08.86		

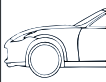
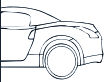
	<b>i</b>	<b>ENGINE</b>	<b>POWER (kW)</b>	<b>YEAR</b>	<b>i</b>	
Fersa KIT FRONT						Fersa KIT REAR
<b>VAUXHALL</b>						
<b>CARLTON MK II</b>						
KA 039	[A.T]	2.0 S Limousine	74	10.78-08.86		
KA 007	[M.T]	2.0 S Estate Car	74	01.82-08.86		
KA 039	[A.T]	2.0 S Estate Car	74	01.82-08.86		
KA 007		2.2i Limousine	85	11.84-08.86		
KA 007		2.2i Estate Car	85	11.84-08.86		
KA 039		2.3 D Limousine; 2.3 D Estate Car	52	05.83-08.86		
<b>CARLTON MK III</b>						
KV 135		1.8 N Limousine	60	09.86-08.87		
KV 135		1.8; 1.8 N Estate Car	60-65	09.86-03.94		KF 136
KV 135		1.8 Limousine; 1.8 S Limousine	65-66	09.86-03.94		
KV 135		1.8 S Estate Car	66	09.86-03.94		
		1.8 S Estate Car	66	09.86-03.94	01.87 -->	KF 136
KV 135		1.8i	85	09.86-03.94		KF 136
KV 135		1.8i Limousine; 2.0 Limousine	73-85	09.86-03.94		
KV 135		2.0; 2.0i	73-74	09.90-03.94		KF 136
KV 135		2.0 Limousine	74-85	09.86-03.94		
KV 135		2.0 Estate Car	85	09.86-03.94	01.87 -->	KF 136
KV 135		2.0i	90	09.86-03.94		KF 136
KV 135		2.0i Limousine	90	09.86-03.94		
KV 135		2.4i Limousine; 2.4i Estate Car; 2.6i Limousine; 2.6i Estate Car; 3.0 Estate Car; 3.0 24V Estate Car; 3000 Limousine; 3000 24V Limousine	92-150	03.87-03.94		KF 136
KV 135		3.6 24V Lotus	277	08.90-09.92		
KV 135		2.2 TD; 2.3 D; 2.3 D Limousine; 2.3 TD INTERC. Limousine; 2.3 TD INTERC. Estate Car	54-74	09.86-03.94		KF 136
<b>CAVALIER</b>						
KA 007		1.3; 1.6 N; 1.6 S; 1.9 S; 1600; 2.0 S	44-74	03.75-08.81		
KA 007		2000	74	08.77-08.81		
KF 134		2.0 S	74	03.78-08.81		KA 007
KF 137	ABS	1.8i	74	88-95		KA 038
<b>CAVALIER MK II</b>						
KF 133		1.3	55	81-10.88		KA 038
KF 133		1.6	55	82-10.88		KA 038
KF 133		1.3 N	44	09.81-08.88		KA 007
KF 134		1.3 N	44	09.81-08.88		KA 007
KF 133		1.3 S	55	09.81-08.88		KA 007
KF 134		1.3 S	55	09.81-08.88		KA 007
KF 133		1.6 N	55	09.81-08.88		KA 007
KF 134		1.6 N	55	09.81-08.88		KA 007
KF 133		1.6i	55	08.86-08.88		KA 007
KF 133		1.6; 1.6 S	66	09.81-08.88		KA 007
KF 134		1.6; 1.6 S	66	09.81-08.88		KA 007
KF 134		1.8; 1.8i; 1800i Convertible; 2.0 SRI 130; 2.0i; 2000i	62-95	09.81-10.88		KA 007
KF 134		1.6 D; 1600D	40	03.82-08.88		KA 007
<b>CAVALIER MK III</b>						
KF 133		1.4	55	09.88-11.95		KA 007
KF 133	--> 12.93 / [M.T]	1.6i	52-55	09.88-11.95		KA 007
KF 134	--> 12.93 / [A.T]	1.6i	52-55	09.88-11.95		KA 007
KF 137	--> 01.94	1.6i	52-55	09.88-11.95		KA 007
		1.6i	52-55	09.88-11.95	[M.T]	KA 007
KF 133	[M.T]	1.6	60	09.88-05.93	[M.T]	KA 007

	<b>i</b>	<b>ENGINE</b>	<b>POWER (kW)</b>	<b>YEAR</b>	<b>i</b>	
Fersa KIT FRONT						Fersa KIT REAR
<b>VAUXHALL</b>						
<b>CAVALIER MK III</b>						
KF 134	[A.T.]	1.6	60	09.88-05.93		
KF 134		1.8	66	09.88-10.92		KA 007
KF 134		1.8i	66	03.90-11.95	--> 12.93	KA 007
KF 134		1.8i	66	03.90-11.95	ABS / --> 12.93	KV 202
KF 134		1.8i	66	03.90-11.95	ABS / --> 01.94	KV 235
KF 134		2.0i	85	09.88-10.92		KA 007
KF 134		2.0i	85	09.90-11.95	--> 12.93	KA 007
KF 134		2.0i	85	09.90-11.95	ABS / --> 12.93	KV 202
KF 134		2.0i	85	09.90-11.95	ABS / --> 01.94	KV 235
KF 134		2.0i 16V 4x4; 2.0i 4x4; 2.0i TURBO 4x4	85-150	09.88-11.95		KF 136
KF 134		2.0i; 2.0i 16V	95-100	09.88-11.95		KA 007
KF 134		2.0i; 2.0i 16V	95-100	09.88-11.95		
KF 134		2.0i 16V	100	09.93-11.95		
KF 134		2.0i 16V	100	09.93-11.95	ABS	KV 202
KF 134		2.0i 16V	100	09.93-11.95		KV 235
KF 134		2.0i 16V	110	09.88-11.95		KA 007
		2.0i 16V	110	09.88-11.95		KA 007
KF 134		2.0i 16V	110	09.88-11.95		
KF 138		2.5 V6	125	02.93-11.95		KV 252
KF 134		1.7 TD	60	09.88-11.95	--> 12.93	KA 007
KF 134		1.7 TD	60	09.88-11.95	ABS / --> 12.93	KV 202
KF 134		1.7 TD	60	09.88-11.95	ABS / --> 01.94	KV 235
KF 134		1.7 D	42	09.88-09.92		KA 007
KF 134		1.7 D	44	07.92-11.95	--> 12.93	KA 007
KF 134		1.7 D	44	07.92-11.95	ABS / --> 12.93	KV 202
KF 134		1.7 D	44	07.92-11.95	ABS / --> 01.94	KV 235
<b>CHEVETTE</b>						
KA 040	--> 04.76 / CH. --> 133466	1.2 Limousine	39	03.75-12.85		
KA 007	05.76--> / CH. 133467	1.2 Limousine	39	03.75-12.85		
KA 007		1.2 Hatchback; 1.2 Estate Car	39	03.75-12.85		
KA 040	--> 04.76 / CH. --> 133466	1.2 Limousine	42	03.75-12.85		
KA 007	05.76--> / CH. 133467	1.2 Limousine	42	03.75-12.85		
KA 007		1.2 Hatchback; 1.2 Estate Car	42	03.75-12.85		
<b>COMBO</b>						
KF 137		1.2	33	07.94-10.01		KA 039
KF 292		1.4	66	01.04-	ABS	KV 202
KF 292		1.4	66	01.04-	ABS	KV 235
KF 137		1.4	44-60	07.94-10.01		KA 039
KF 292		1.6	64	10.01-	ABS	KV 202
KF 292		1.6	64	10.01-	ABS	KV 235
KF 137		1.7 D	44	07.94-10.01		KA 039
KF 292		1.7 DI 16V; 1.7 DTI 16V	48-55	09.01-	ABS	KV 202
KF 292		1.7 DI 16V; 1.7 DTI 16V	48-55	09.01-	ABS	KV 235
<b>CORSA MK II</b>						
KF 137		1.0i 12V; 1.2i; 1.2i 16V	33-48	03.93-09.00		KA 007
		1.0i 12V; 1.2i; 1.2i 16V	33-48	03.93-09.00		KA 007
KF 137		1.0i 12V; 1.2i; 1.2i 16V	33-48	03.93-09.00		
KF 137		1.4i	44	03.93-09.00		KA 007
KF 133		1.4i	44	03.93-09.00		KA 007
KF 137		1.4i 16V; 1.4i S; 1.6 GSI 16V; 1.6i 16V	60-80	03.93-		KA 007

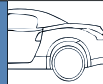

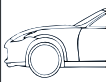
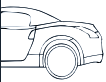
	<b>i</b>	ENGINE	POWER (kW)	YEAR	<b>i</b>	
Fersa KIT FRONT						Fersa KIT REAR
<b>VAUXHALL</b>						
<b>CORSA MK II</b>						
KF 137		1.5 D; 1.5 TD; 1.7 D	37-49	03.93-09.00		KA 007
KF 137		1.5 D; 1.5 TD; 1.7 D	37-49	03.93-09.00		
KF 292		1.0 12V; 1.2 16V; 1.2 16V Dualfuel; 1.4 16V; 1.8 16V	43-92	09.00-	DISC BRAKE	KV 337
KF 292		1.0 12V; 1.2 16V; 1.2 16V Dualfuel; 1.4 16V; 1.8 16V	43-92	09.00-	DRUM BRAKE	KB 338
KF 292		1.3 CDTi 16V; 1.7 DTi 16V	48-55	09.00-	DISC BRAKE	KV 337
KF 292		1.3 CDTi 16V; 1.7 DTi 16V	48-55	09.00-	DRUM BRAKE	KB 338
KF 134		1.7 CDTi 16V	74	04.04-	DISC BRAKE	KV 337
KF 134		1.7 CDTi 16V	74	04.04-	DRUM BRAKE	KB 338
<b>CORSAVAN MK II</b>						
KF 292		1.2 16V; 1.2 16V Dualfuel	55	09.00-	DISC BRAKE	KV 337
KF 292		1.2 16V; 1.2 16V Dualfuel	55	09.00-	DRUM BRAKE	KB 338
KF 292		1.3 CDTi 16V; 1.7 DI 16V; 1.7 DTi 16V	48-55	09.00-	DISC BRAKE	KV 337
KF 292		1.3 CDTi 16V; 1.7 DI 16V; 1.7 DTi 16V	48-55	09.00-	DRUM BRAKE	KB 338
<b>MERIVA</b>						
KF 292		1.6i; 1.6i 16V; 1.8i 16V	64-92	05.03-	ABS	KV 202
KF 292		1.6i; 1.6i 16V; 1.8i 16V	64-92	05.03-	<del>ABS</del>	KV 235
KF 292		1.7 CDTi 16V	74	04.04-	ABS	KV 202
KF 292		1.7 CDTi 16V	74	04.04-	<del>ABS</del>	KV 235
<b>MOVANO</b>						
KB 293		1.9 DTi; 2.2 DTi; 2.5 CDTi; 2.5 D; 2.5 DTi; 2.8 DTi; 2.8 TDi; 3.0 Dti	59-100	10.98-		
KB 278		1.9 DTi; 2.2 DTi; 2.5 CDTi; 2.5 D; 2.5 DTi; 2.8 DTi; 2.8 TDi; 3.0 Dti	59-100	10.98-		
		1.9 DTi; 2.2 DTi; 2.5 CDTi; 2.5 D; 2.5 DTi; 2.8 DTi; 2.8 TDi; 3.0 Dti	59-100	10.98-		KB 344
<b>NOVA</b>						
KF 133		1.0; 1.2; 1.2 N; 1.2 S; 1.2i; 1.3 S; 1.3i; 1.4; 1.4 S; 1.4i; 1.4i S; 1.6 GSi	33-74	09.82-03.93	<del>ABS</del>	KA 007
KF 133		1.5 D; 1.5 TD	37-49	09.87-03.93	ABS	KA 007
KF 133		1.5 D; 1.5 TD	37-49	09.87-03.93		
<b>NOVAVAN</b>						
KF 133		1.2	38	01.90-10.94	<del>ABS</del>	KA 007
KF 133		1.5 D	37	01.91-10.94	<del>ABS</del>	KA 007
<b>OMEGA</b>						
KV 135		2.0; 2.0i	85	03.94-12.00		KF 138
KV 135		2.0; 2.0i	85	03.94-12.00		KF 136
KV 135		2.0 16V; 2.0i	85-100	03.94-09.99		KF 136
KV 135		2.0i 16V	100	03.94-09.99		KF 138
KV 135		2.0i 16V	100	03.94-09.99		KF 136
KV 135		2.2i	106	09.99-		KF 136
KV 135		2.2i; 2.5i	106-125	03.94-		KF 138
KV 135		2.2i; 2.5i	106-125	03.94-		KF 136
KV 135		2.5i	125	03.94-09.00		KF 136
KV 135		2.6 V6	132	09.00-		KF 138
KV 135		2.6 V6	132	09.00-		KF 136
KV 135		2.6 V6; 3.0 MV 6	132-155	04.94-		KF 136
KV 135		3.0 MV6; 3.2 V6	155-160	04.94-		KF 138
KV 135		3.0 MV6; 3.2 V6	155-160	04.94-		KF 136
KV 135		3.2 V6	160	02.01-		KF 136
KV 135		2.0 DTi 16V	74	10.98-09.00		KF 136
KV 135		2.0 TDi 16V; 2.2 DTi 16V	74-88	10.98-		KF 138

	<b>i</b>	<b>ENGINE</b>	<b>POWER (kW)</b>	<b>YEAR</b>	<b>i</b>	
Fersa KIT FRONT						Fersa KIT REAR
<b>VAUXHALL</b>						
<b>OMEGA</b>						
<b>KV 135</b>		2.0TDi 16V; 2.2 DTi 16V	74-88	10.98-		<b>KF 136</b>
<b>KV 135</b>		2.2 DTi 16V	88	09.00-		<b>KF 136</b>
<b>KV 135</b>		2.5 TD	96	04.94-02.01		<b>KF 138</b>
<b>KV 135</b>		2.5 TD	96	04.94-02.01		<b>KF 136</b>
<b>KV 135</b>		2.5 DTi 24V	110	09.01-		<b>KF 138</b>
<b>KV 135</b>		2.5 DTi 24V	110	09.01-		<b>KF 136</b>
<b>ROYALE</b>						
<b>KA 039</b>		2.0 E; 2.2 E	85	03.83-08.87		
<b>KA 039</b>	CH. 91362918 -->	2.5	85	05.78-12.80		
<b>KA 039</b>		2.5 E	100-103	01.83-08.87		
<b>KA 039</b>	CH. 91362918 -->	2.8; 2.9	103-110	02.78-10.82		
<b>KA 039</b>		2.9	115	09.85-08.87		
<b>KA 039</b>	CH. 91362918 -->	2.9; 2.9 E; 3.0	132	02.78-12.86		
<b>KA 039</b>		2.2 TD	63	11.84-08.87		
<b>SENATOR MK II</b>						
<b>KV 135</b>		2.5i	103	09.84-08.87		<b>KF 136</b>
<b>KV 135</b>		2.5i; 2.6i; 3.0; 3.0 24V; 3.0i	103-150	09.87-09.93		<b>KF 136</b>
<b>SIGNUM</b>						
<b>KV 343</b>	--> 12.04	2.0i Turbo; 2.2i; 3.2 V6	114-155	05.03-		<b>KV 336</b>
<b>KV 335</b>	01.05 -->	2.0i Turbo; 2.2i; 3.2 V6	114-155	05.03-		<b>KV 336</b>
<b>KV 343</b>	--> 12.04	1.9 CDTi; 1.9 CDTi 16V; 2.0 DTi; 2.2 DTi; 3.0 CDTi	74-130	05.03-		<b>KV 336</b>
<b>KV 335</b>	01.05 -->	1.9 CDTi; 1.9 CDTi 16V; 2.0 DTi; 2.2 DTi; 3.0 CDTi	74-130	05.03-		<b>KV 336</b>
<b>TIGRA</b>						
<b>KF 137</b>		1.4 16V; 1.6 16V	66-78	07.94-		<b>KA 007</b>
<b>TIGRA TWINTOP</b>						
<b>KF 292</b>		1.4; 1.8	66-92	06.04-	DISC BRAKE	<b>KV 337</b>
<b>KF 292</b>		1.4; 1.8	66-92	06.04-	DRUM BRAKE	<b>KB 338</b>
<b>KF 292</b>		1.3 CDTi	51	06.04-	DISC BRAKE	<b>KV 337</b>
<b>KF 292</b>		1.3 CDTi	51	06.04-	DRUM BRAKE	<b>KB 338</b>
<b>VECTRA MK II</b>						
<b>KF 138</b>		1.6i	55	10.95-	--> 12.98 / CH. --> W1999999	<b>KV 202</b>
<b>KF 138</b>		1.6i	55	10.95-	01.99 --> / CH. X1000001 -->	<b>KV 252</b>
<b>KF 138</b>		1.6i	55	11.96-		<b>KV 252</b>
<b>KF 138</b>		1.6i 16V; 1.8i 16V	74-85	10.95-	--> 12.98 / CH. --> W1999999	<b>KV 202</b>
<b>KF 138</b>		1.6i 16V; 1.8i 16V	74-85	10.95-	01.99 --> / CH. X1000001 -->	<b>KV 252</b>
<b>KF 138</b>		1.8i 16V; 2.0i 16V; 2.2i 16V; 2.5i GSi; 2.5i V6; 2.6i V6	92-143	10.95-		<b>KV 252</b>
<b>KF 138</b>		1.7 TD	60	10.95-11.96		<b>KV 202</b>
<b>KF 138</b>		2.0 DI 16V; 2.0 DTi 16V	60-74	11.96-	--> 12.98 / CH. --> W1999999	<b>KV 202</b>
<b>KF 138</b>		2.0 DI 16V; 2.0 DTi 16V	60-74	11.96-	01.99 --> / CH. X1000001 -->	<b>KV 252</b>
<b>KF 138</b>		2.2 DTi 16V	92	09.00-		<b>KV 252</b>
<b>KV 343</b>	CH. --> 41999999 / CH. --> 48999999	1.6; 1.6 16V; 1.8; 1.8 16V; 1.8 16V Dualfuel; 2.0 16V Turbo; 2.2 16V; 2.2 direct; 2.8 V6 Turbo; 3.2 V6	74-188	04.02-		<b>KV 336</b>
<b>KV 335</b>	CH. 51000001 --> / CH. 58000001 -->	1.6; 1.6 16V; 1.8; 1.8 16V; 1.8 16V Dualfuel; 2.0 16V Turbo; 2.2 16V; 2.2 direct; 2.8 V6 Turbo; 3.2 V6	74-188	04.02-		<b>KV 336</b>
<b>KV 343</b>	CH. --> 41999999 / CH. --> 48999999	1.9 CDTi; 1.9 CDTi 16V; 2.0 DTi 16V; 2.2 DTi 16V; 3.0 CDTi; 3.0 V6 CDTi	74-135	04.02-		<b>KV 336</b>
<b>KV 335</b>	CH. 51000001 --> / CH. 58000001 -->	1.9 CDTi; 1.9 CDTi 16V; 2.0 DTi 16V; 2.2 DTi 16V; 3.0 CDTi; 3.0 V6 CDTi	74-135	04.02-		<b>KV 336</b>
<b>VIVARO</b>						
<b>KF 340</b>	ABS / CH. --> 3V613233	2.0 16V	88	08.01-		<b>KB 339</b>
<b>KF 315</b>	ABS / CH. --> 3V613233	2.0 16V	88	08.01-		<b>KB 339</b>

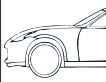
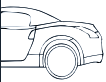

	<b>i</b>	<b>ENGINE</b>	<b>POWER (kW)</b>	<b>YEAR</b>	<b>i</b>	
Fersa KIT FRONT						Fersa KIT REAR
<b>VAUXHALL</b>						
<b>VIVARO</b>						
<b>KF 334</b>	CH. 3V613234 -->	2.0 16V	88	08.01-		<b>KB 339</b>
		2.0 16V	88	08.01-		<b>KB 339</b>
<b>KF 340</b>	ABS / CH. --> 3V613233	1.9 DI; 1.9 DTI	59-74	08.01-		<b>KB 339</b>
<b>KF 315</b>	ABS / CH. --> 3V613233	1.9 DI; 1.9 DTI	59-74	08.01-		<b>KB 339</b>
<b>KF 334</b>	CH. 3V613234 -->	1.9 DI; 1.9 DTI	59-74	08.01-		<b>KB 339</b>
		1.9 DI; 1.9 DTI	59-74	08.01-		<b>KB 339</b>
<b>KF 334</b>		2.5 DTI	99	04.04-		<b>KB 339</b>
<b>ZAFIRA MK II</b>						
<b>KV 199</b>	ABS	1.6 16V; 1.8 16V	74-92	04.99-	ABS	<b>KV 252</b>
<b>KV 247</b>	ABS	1.6 16V; 1.8 16V	74-92	04.99-	ABS	<b>KV 279</b>
<b>KV 199</b>	ABS	2.0 GSI TURBO; 2.2 16V	108-141	09.00-	ABS	<b>KV 252</b>
<b>KV 198</b>	ABS	2.0 GSI TURBO; 2.2 16V	108-141	09.00-	ABS	<b>KV 252</b>
<b>KV 247</b>	ABS	2.0 GSI TURBO; 2.2 16V	108-141	09.00-	ABS	<b>KV 279</b>
<b>KV 196</b>	ABS	2.0 GSI TURBO; 2.2 16V	108-141	09.00-	ABS	<b>KV 279</b>
<b>KV 199</b>	ABS	2.0 DI 16V; 2.0 DTI 16V	60-74	04.99-	ABS	<b>KV 252</b>
<b>KV 247</b>	ABS	2.0 DI 16V; 2.0 DTI 16V	60-74	04.99-	ABS	<b>KV 279</b>
<b>KV 332</b>		1.6; 1.8	77-103	07.05-		<b>KV 331</b>
<b>KV 332</b>	CH. --> 62034065	2.0	147	07.05-		<b>KV 331</b>
<b>KV 332</b>	CH. --> 6G019309	2.0	147	07.05-		<b>KV 331</b>
		2.0	177	01.06-		<b>KV 331</b>
<b>KV 332</b>	CH. --> 62034065	2.2	110	07.05-		<b>KV 331</b>
<b>KV 332</b>	CH. --> 6G019309	2.2	110	07.05-		<b>KV 331</b>
<b>KV 332</b>	CH. --> 62034065	1.9 CDTI	88	07.05-		<b>KV 331</b>
<b>KV 332</b>	CH. --> 6G019309	1.9 CDTI	88	07.05-		<b>KV 331</b>
		1.9 CDTI	110	07.05-		<b>KV 331</b>
<b>VOLKSWAGEN</b>						
<b>BORA (1J2,1J6)</b>						
<b>KF 184</b>		1.4i 16V, 1.6i, 1.8i 20V, 1.9 TDi, 2.0i, 2.3i VR5, 2.8i V6	55-132	99-		<b>KV 097</b>
<b>KF 184</b>		1.4 16V; 1.6; 1.6 16V; 1.6 FSi; 1.8; 1.8 T	55-132	10.98-05.05		<b>KV 194</b>
<b>KF 184</b>		1.8i 20V, 1.9 Tdi, 2.0i	92	99-		<b>KV 097</b>
<b>KF 184</b>		1.8 4motion	92	02.99-05.05		<b>KF 184</b>
<b>KF 184</b>		2.0	85	10.98-05.05		<b>KV 194</b>
<b>KF 184</b>		2.0 4motion	85	04.00-05.05		<b>KF 184</b>
<b>KF 184</b>		2.3 V5; 2.3 VR5	110-125	10.98-05.05		<b>KV 194</b>
<b>KF 184</b>		2.3 V5 4motion; 2.8 V6 4motion	110-150	12.98-05.05		<b>KF 184</b>
<b>KF 184</b>		1.9 SDi; 1.9 TDI	50-110	10.98-05.05		<b>KV 194</b>
<b>KF 184</b>		1.9 TDI 4motion	66-110	02.99-05.05		<b>KF 184</b>
<b>CADDY I</b>						
<b>KF 179</b>		1.5; 1.6; 1.8	51-70	08.82-07.92		<b>KA 005</b>
<b>KF 179</b>		1.5; 1.6; 1.8	51-70	08.82-07.92		
<b>KF 179</b>		1.6 D	40	08.82-07.92		<b>KA 005</b>
<b>KF 179</b>		1.6 D	40	08.82-07.92		
<b>CADDY II</b>						
<b>KF 182</b>		1.4 Estate Car; 60 1.4 Bus	44	11.95-01.04	CH. --> 9K-W-503258	<b>KA 005</b>
<b>KF 182</b>		1.4 Estate Car; 60 1.4 Bus	44	11.95-01.04	CH. 9K-W-503259 --> / CH. --> 9K-Y-500748	<b>KA 248</b>
<b>KF 182</b>		1.4 Bus	55	08.00-01.04	CH. 9K-W-503259 --> / CH. --> 9K-Y-500748	<b>KA 248</b>

	<b>i</b>	<b>ENGINE</b>	<b>POWER (kW)</b>	<b>YEAR</b>	<b>i</b>	
Fersa KIT FRONT						Fersa KIT REAR
<b>VOLKSWAGEN</b>						
<b>CADDY II</b>						
<b>KF 182</b>		1.4 16V Estate Car; 1.6; 1.6 Estate Car; 75 1.6 Bus	55-65	11.95-01.04		
<b>KF 182</b>		1.4 16V Estate Car; 1.6; 1.6 Estate Car; 75 1.6 Bus	55-65	11.95-01.04	CH. --> 9K-W-503258	<b>KA 005</b>
<b>KF 182</b>		1.4 16V Estate Car; 1.6; 1.6 Estate Car; 75 1.6 Bus	55-65	11.95-01.04	CH. 9K-W-503259 --> / CH. --> 9K-Y-500748	<b>KA 248</b>
<b>KF 182</b>		75 1.6 Bus	55	11.95-09.00		
<b>KF 182</b>		75 1.6 Bus	55	11.95-09.00	CH. --> 9K-W-503258	<b>KA 005</b>
<b>KF 182</b>		75 1.6 Bus	55	11.95-09.00	CH. 9K-W-503259 --> / CH. --> 9K-Y-500748	<b>KA 248</b>
<b>KF 159</b>		1.6 Pick-Up	55	06.96-12.00		<b>KA 006</b>
<b>KF 182</b>		1.7 SDI Estate Car; 1.7 SDI Bus; 1.9 D Estate Car; 1.9 D Bus	42-47	11.95-01.04	CH. --> 9K-W-503258	<b>KA 005</b>
<b>KF 182</b>		1.7 SDI Estate Car; 1.7 SDI Bus; 1.9 D Estate Car; 1.9 D Bus	42-47	11.95-01.04	CH. 9K-W-503259 --> / CH. --> 9K-Y-500748	<b>KA 248</b>
<b>KF 182</b>		1.9 SDI Estate Car	47	11.95-01.04	CH. --> 9K-W-503258	<b>KA 005</b>
<b>KF 182</b>		1.9 SDI Estate Car	47	11.95-01.04	CH. 9K-W-503259 --> / CH. --> 9K-Y-500748	<b>KA 248</b>
<b>KF 182</b>		1.9 SDI Bus	47	11.95-01.04	CH. --> 9K-W-503258	<b>KA 005</b>
<b>KF 182</b>		1.9 SDI Bus	47	11.95-01.04	CH. 9K-W-503259 --> / CH. --> 9K-Y-500748	<b>KA 248</b>
<b>KF 159</b>		1.9 D Pick-Up	47	06.96-12.00		<b>KA 006</b>
<b>KF 182</b>		1.9 TDI Estate Car; 1.9 TDI Bus	66	09.96-01.04	CH. --> 9K-W-503258	<b>KA 005</b>
<b>KF 182</b>		1.9 TDI Estate Car; 1.9 TDI Bus	66	09.96-01.04	CH. 9K-W-503259 --> / CH. --> 9K-Y-500748	<b>KA 248</b>
<b>CORRADO (53I)</b>						
<b>KF 182</b>		1.8 16V; 1.8 G60; 2.0i; 2.0i 16V	85-118	09.88-12.95		<b>KA 006</b>
<b>KF 183</b>		2.9 VR6	140	08.91-12.95		<b>KA 006</b>
<b>DERBY (86)</b>						
<b>KF 180</b>		0.9; 1.1; 1.3	29-44	02.77-09.81		<b>KA 006</b>
<b>DERBY (86C)</b>						
<b>KF 180</b>		1.0; 1.1; 1.3	29-55	08.81-12.84		<b>KA 006</b>
		1.0; 1.1; 1.3	29-55	08.81-12.84		<b>KA 006</b>
<b>KF 180</b>		1.0; 1.1; 1.3	29-55	08.81-12.84		
<b>FOX (5Z1)</b>						
<b>KV 287</b>		1.2	40	04.05-		<b>KV 286</b>
<b>KV 287</b>		1.4	55	04.05-		<b>KV 286</b>
<b>KV 287</b>		1.4 TDI	51	04.05-		<b>KV 286</b>
<b>GOLF I</b>						
<b>KF 179</b>		1.1; 1.3; 1.5; 1.5 Cabriolet Convertible; 1.6; 1.6 Cabriolet Convertible; 1.6 GTI; 1.8 Cabriolet Convertible; 1.8 GTI	37-82	04.74-04.93		<b>KA 006</b>
<b>KF 179</b>		1.5 D; 1.6 D; 1.6 TD	37-51	08.76-07.83		<b>KA 006</b>
		1.5 D; 1.6 D; 1.6 TD	37-51	08.76-07.83		<b>KA 006</b>
<b>GOLF II</b>						
<b>KF 179</b>	--> 06.84 / CH. --> E299999	1.0	33	11.83-08.85		<b>KA 006</b>
<b>KF 181</b>	07.84 --> / CH. E300001 -->	1.0	33	11.83-08.85		<b>KA 006</b>
		1.0	33	11.83-08.85		<b>KA 006</b>
<b>KF 181</b>	--> 12.87	1.0	37	08.85-10.91		<b>KA 006</b>
<b>KF 182</b>	01.88 -->	1.0	37	08.85-10.91		<b>KA 006</b>
		1.0	37	08.85-10.91		<b>KA 006</b>
<b>KF 181</b>		1.3	37	08.85-12.87		<b>KA 006</b>
		1.3	37	08.85-12.87		<b>KA 006</b>
<b>KF 181</b>	--> 12.87	1.3	40	06.86-12.92		<b>KA 006</b>
<b>KF 182</b>	01.88 -->	1.3	40	06.86-12.92		<b>KA 006</b>
		1.3	40	06.86-12.92		<b>KA 006</b>

	<b>i</b>	ENGINE	POWER (kW)	YEAR	<b>i</b>	
Fersa KIT FRONT						Fersa KIT REAR
<b>VOLKSWAGEN</b>						
<b>GOLF II</b>						
<b>KF 179</b>	--> 06.84 / CH. --> E299999	1.3	40-44	08.83-06.87		<b>KA 006</b>
<b>KF 181</b>	07.84 --> / CH. E300001 -->	1.3	40-44	08.83-06.87		<b>KA 006</b>
		1.3	40-44	08.83-06.87		<b>KA 006</b>
<b>KF 181</b>	--> 12.87	1.6	51-53	02.86-12.92		<b>KA 006</b>
<b>KF 182</b>	01.88 -->	1.6	51-53	02.86-12.92		<b>KA 006</b>
		1.6	51-53	02.86-12.92		<b>KA 006</b>
<b>KF 179</b>	--> 12.84 / CH. --> E299999	1.6	55	08.83-07.92		<b>KA 006</b>
<b>KF 181</b>	01.85 --> / --> 12.87 / CH. E300001 -->	1.6	55	08.83-07.92		<b>KA 006</b>
<b>KF 182</b>	01.88 -->	1.6	55	08.83-07.92		<b>KA 006</b>
		1.6	55	08.83-07.92		<b>KA 006</b>
<b>KF 181</b>	--> 12.87	1.8	62	08.86-01.90		<b>KA 006</b>
<b>KF 182</b>	01.88 -->	1.8	62	08.86-01.90		<b>KA 006</b>
		1.8	62	08.86-01.90		<b>KA 006</b>
<b>KF 179</b>	--> 12.84 / CH. --> E299999	1.8	66	08.84-10.91		<b>KA 006</b>
<b>KF 181</b>	01.85 --> / --> 12.87 / CH. E300001 -->	1.8	66	08.84-10.91		<b>KA 006</b>
<b>KF 182</b>	01.88 -->	1.8	66	08.84-10.91		<b>KA 006</b>
		1.8	66	08.84-10.91		<b>KA 006</b>
<b>KF 181</b>	--> 12.87	1.8 SYNCRO; 1.8i SYNCRO	66	02.86-10.91		<b>KA 006</b>
<b>KF 182</b>	01.88 -->	1.8 SYNCRO; 1.8i SYNCRO	66	02.86-10.91		<b>KA 006</b>
		1.8 SYNCRO; 1.8i SYNCRO	66	02.86-10.91		<b>KF 182</b>
		1.8 SYNCRO; 1.8i SYNCRO	66	02.86-10.91		<b>KF 095</b>
<b>KF 181</b>	--> 12.87	1.8 GTI; 1.8i	66-79	01.87-10.91		<b>KA 006</b>
<b>KF 182</b>	01.88 -->	1.8 GTI; 1.8i	66-79	01.87-10.91		<b>KA 006</b>
<b>KF 182</b>		1.8 GTI G60 SYNCRO; 1.8 SYNCRO	72-118	08.88-07.91		<b>KF 182</b>
<b>KF 182</b>		1.8 GTI G60 SYNCRO; 1.8 SYNCRO	72-118	08.88-07.91		<b>KF 095</b>
<b>KF 182</b>		1.8 GTI G60 SYNCRO; 1.8 SYNCRO	72-118	08.88-07.91		
		1.8 GTI G60 SYNCRO; 1.8 SYNCRO	72-118	08.88-07.91		<b>KF 182</b>
		1.8 GTI G60 SYNCRO; 1.8 SYNCRO	72-118	08.88-07.91		<b>KF 095</b>
<b>KF 181</b>		1.8 GTI	79	08.85-10.87		<b>KA 006</b>
<b>KF 179</b>	--> 12.84 / CH. --> E299999	1.8 GTI	82	08.83-10.91		<b>KA 006</b>
<b>KF 181</b>	01.85 --> / --> 12.87 / CH. E300001 -->	1.8 GTI	82	08.83-10.91		<b>KA 006</b>
<b>KF 182</b>	01.88 -->	1.8 GTI	82	08.83-10.91		<b>KA 006</b>
<b>KF 181</b>	--> 12.87	1.8 GTI 16V	95-102	02.86-10.91		<b>KA 006</b>
<b>KF 182</b>	01.88 -->	1.8 GTI 16V	95-102	02.86-10.91		<b>KA 006</b>
<b>KF 182</b>		1.8 GTI G60	118	04.90-07.91		<b>KA 006</b>
<b>KF 179</b>	--> 12.84 / CH. --> E299999	1.6 D; 1.6 TD	37-51	08.83-10.91		<b>KA 006</b>
<b>KF 181</b>	01.85 --> / --> 12.87 / CH. E300001 -->	1.6 D; 1.6 TD	37-51	08.83-10.91		<b>KA 006</b>
<b>KF 182</b>	01.88 -->	1.6 D; 1.6 TD	37-51	08.83-10.91		<b>KA 006</b>
<b>KF 182</b>		1.6 TD	44-59	04.89-10.91		<b>KA 006</b>
<b>GOLF III</b>						
<b>KF 182</b>		1.4; 1.6; 1.8	40-74	10.91-04.99		<b>KA 006</b>
<b>KF 182</b>		1.8 SYNCRO; 1.8 SYNCRO (1HX1)	66	01.93-04.99		<b>KF 095</b>
<b>KF 182</b>		2.0; 2.0 GTI	85	11.91-04.99		<b>KA 006</b>
<b>KF 182</b>		2.0 SYNCRO; 2.0 SYNCRO (1HX1)	85	08.95-04.99		<b>KF 095</b>
<b>KF 183</b>		2.0 GTI 16V	110	08.92-08.97		<b>KA 006</b>
<b>KF 183</b>		2.8 VR6; 2.9 VR6	128-140	01.92-04.99		<b>KA 006</b>
<b>KF 183</b>		2.9 VR6 SYNCRO; 2.9 VR6 SYNCRO (1HX1)	140	10.94-04.99		<b>KF 182</b>
<b>KF 182</b>		1.9 D; 1.9 SDI; 1.9 TD; 1.9 TD,GTD; 1.9 TDI	47-81	11.91-04.99		<b>KA 006</b>

	<b>i</b>	<b>ENGINE</b>	<b>POWER (kW)</b>	<b>YEAR</b>	<b>i</b>	
Fersa KIT FRONT						Fersa KIT REAR
<b>VOLKSWAGEN</b>						
<b>GOLF III</b>						
<b>KF 182</b>		1.9 TDI; 1.9 TDI SYNCRO	66	07.95-04.99		<b>KF 095</b>
<b>KF 184</b>		1.4 Hatchback; 1.4 Estate Car; 1.6 Hatchback; 1.6 Estate Car	55-74	08.97-		<b>KV 194</b>
<b>GOLF IV</b>						
<b>KF 182</b>		1.6 Convertible	74	06.98-06.02		<b>KA 006</b>
<b>KF 184</b>		1.6 Hatchback; 1.6 Estate Car; 1.6 16V Hatchback; 1.6 16V Estate Car; 1.6 FSI Hatchback; 1.6 FSI Estate Car	75-81	02.00-		<b>KV 194</b>
<b>KF 182</b>		1.8 Convertible	55-66	06.98-06.02		<b>KA 006</b>
<b>KF 184</b>		1.8 4motion Hatchback; 1.8 4motion Estate Car	92	05.98-		<b>KF 184</b>
<b>KF 184</b>		1.8 Hatchback; 1.8 T Hatchback; 1.8 T Estate Car; 1.8 T GTI Hatchback	92-132	08.97-		<b>KV 194</b>
<b>KF 182</b>		2.0 Convertible	85	06.98-06.02		<b>KA 006</b>
<b>KF 184</b>		2.0 Estate Car; 2.0 [20]; 2.0 Bi-Fuel Estate Car	85	07.98-		<b>KV 194</b>
<b>KF 184</b>		2.0 4motion Hatchback; 2.0 4motion Estate Car	85	10.00-		<b>KF 184</b>
<b>KF 184</b>		2.3 V5 Hatchback; 2.3 V5 Estate Car	110-125	08.97-		<b>KV 194</b>
<b>KF 184</b>		2.3 V5 4motion Hatchback; 2.3 V5 4motion Estate Car; 2.8 V6 4motion Hatchback; 2.8 V6 4motion Estate Car; 3.2 R32 4motion Hatchback	110-177	12.98-		<b>KF 184</b>
<b>KF 184</b>		1.9 SDI Hatchback; 1.9 SDI Estate Car; 1.9 TDI Hatchback; 1.9 TDI Estate Car	50-66	08.97-		<b>KV 194</b>
		1.9 SDI Hatchback; 1.9 SDI Estate Car; 1.9 TDI Hatchback; 1.9 TDI Estate Car	50-66	08.97-		<b>KV 194</b>
<b>KF 182</b>		1.9 TDI Convertible	66	06.98-06.02		<b>KA 006</b>
<b>KF 182</b>		1.9 TDI Convertible	66	06.98-06.02		
<b>KF 184</b>		1.9 TDI 4motion Hatchback; 1.9 TDI 4motion Estate Car	66-110	07.98-		<b>KF 184</b>
<b>KF 184</b>		1.9 TDI Hatchback; 1.9 TDI Estate Car	74	09.00-		<b>KV 194</b>
<b>KF 182</b>		1.9 TDI Convertible	81	06.98-06.02		<b>KA 006</b>
<b>KF 184</b>		1.9 TDI Hatchback; 1.9 TDI Estate Car	81-110	08.97-		<b>KV 194</b>
<b>JETTA I</b>						
<b>KF 179</b>		1.1; 1.3; 1.5; 1.6; 1.6 GLI; 1.8	37-82	08.78-02.84		<b>KA 006</b>
<b>KF 179</b>		1.5 D; 1.6 D; 1.6 TD	37-51	08.78-02.84		<b>KA 006</b>
<b>JETTA II</b>						
<b>KF 181</b>	--> 12.87	1.3	40	06.87-12.91		<b>KA 006</b>
<b>KF 182</b>	01.88 -->	1.3	40	06.87-12.91		<b>KA 006</b>
<b>KF 179</b>	--> 06.84 / CH. --> E299999	1.3	40-44	01.84-06.87		<b>KA 006</b>
<b>KF 181</b>	07.84 --> / CH. E300001 -->	1.3	40-44	01.84-06.87		<b>KA 006</b>
<b>KF 181</b>	--> 12.87	1.6	51-53	03.86-10.91		<b>KA 006</b>
<b>KF 182</b>	01.88 -->	1.6	51-53	03.86-10.91		<b>KA 006</b>
<b>KF 179</b>	--> 12.84 / CH. --> E299999	1.6	55	01.84-07.92		<b>KA 006</b>
<b>KF 181</b>	01.85 --> / --> 12.87 / CH. E300001 -->	1.6	55	01.84-07.92		<b>KA 006</b>
<b>KF 182</b>	01.88 -->	1.6	55	01.84-07.92		<b>KA 006</b>
<b>KF 181</b>	--> 12.87	1.8	62-79	08.84-10.91		<b>KA 006</b>
<b>KF 182</b>	01.88 -->	1.8	62-79	08.84-10.91		<b>KA 006</b>
<b>KF 182</b>		1.8 SYNCRO	66-72	08.87-07.91		<b>KF 095</b>
<b>KF 181</b>		1.8	79	08.85-10.87		<b>KA 006</b>
<b>KF 179</b>	--> 06.84 / CH. --> E299999	1.8	82	01.84-10.91		<b>KA 006</b>
<b>KF 181</b>	07.84 --> / --> 12.87 / CH. E300001 -->	1.8	82	01.84-10.91		<b>KA 006</b>
<b>KF 182</b>	01.88 -->	1.8	82	01.84-10.91		<b>KA 006</b>
		1.8	82	01.84-10.91		<b>KA 006</b>
<b>KF 181</b>	--> 12.87	1.8 16V	95-102	08.86-10.91		<b>KA 006</b>
<b>KF 182</b>	01.88 -->	1.8 16V	95-102	08.86-10.91		<b>KA 006</b>
		1.8 16V	95-102	08.86-10.91		<b>KA 006</b>

	<b>i</b>	<b>ENGINE</b>	<b>POWER (kW)</b>	<b>YEAR</b>	<b>i</b>	
Fersa KIT FRONT						Fersa KIT REAR
<b>VOLKSWAGEN</b>						
<b>JETTA II</b>						
<b>KF 179</b>	--> 06.84 / CH. --> E299999	1.6 D	40	01.84-10.91		<b>KA 006</b>
<b>KF 181</b>	07.84 --> / --> 12.87 / CH. E300001 -->	1.6 D	40	01.84-10.91		<b>KA 006</b>
<b>KF 182</b>	01.88 -->	1.6 D	40	01.84-10.91		<b>KA 006</b>
		1.6 D	40	01.84-10.91		<b>KA 006</b>
<b>KF 179</b>	--> 06.84 / CH. --> E299999	1.6 TD	51	01.84-10.91		<b>KA 006</b>
<b>KF 181</b>	07.84 --> / --> 12.87 / CH. E300001 -->	1.6 TD	51	01.84-10.91		<b>KA 006</b>
<b>KF 182</b>	01.88 -->	1.6 TD	51	01.84-10.91		<b>KA 006</b>
<b>KF 182</b>		1.6 TD	44-59	04.89-10.91		<b>KA 006</b>
<b>KF 182</b>		1.6 TD	44-59	04.89-10.91		
<b>KA 006</b>	01.75 --> / --> 12.78	1200 1.2 (11)	25	01.60-12.85		
<b>KA 006</b>		1302 1.2 (11)	25	08.69-08.72		
<b>KARMANN GHIA (14,34)</b>						
<b>KA 006</b>		1500	32	01.66-12.69		
<b>KA 006</b>		1600	35-37	01.70-07.74		
<b>LT 28-35 I</b>						
<b>KA 071</b>		2.0 Bus; 2.0 Bus; 2.0 Platform	55	04.75-09.83		<b>KA 072</b>
<b>KA 071</b>		2.4 Bus; 2.4 Bus; 2.4 Platform	66	12.82-07.92		<b>KA 072</b>
<b>KA 071</b>		2.4i Bus	69	08.89-06.96		<b>KA 072</b>
<b>KA 071</b>		2.4i Bus; 2.4i Platform	69	03.94-06.96		<b>KA 072</b>
<b>KA 071</b>		2.4 D Bus; 2.4 D Bus; 2.4 D Platform	51	08.89-06.96		<b>KA 072</b>
<b>KA 071</b>		2.4 D Platform	55	12.78-02.91		<b>KA 072</b>
<b>KA 071</b>		2.4 D Bus; 2.4 D Bus	55	01.79-07.92		<b>KA 072</b>
<b>KA 071</b>		2.4 TD Bus; 2.4 TD Bus; 2.4 TD Platform	68	08.88-08.92		<b>KA 072</b>
<b>KA 071</b>		2.4 D Bus; 2.4 D Bus; 2.4 TD Platform	70	06.92-06.96		<b>KA 072</b>
<b>KA 071</b>		2.4 TD Bus	75	12.82-07.89		<b>KA 072</b>
<b>KA 071</b>		2.4 TD Bus; 2.4 TD Platform	75	12.82-09.93		<b>KA 072</b>
<b>KA 071</b>		2.7 D Bus; 2.7 D Platform	48	11.75-01.80		<b>KA 072</b>
<b>LT 40-55 I</b>						
<b>KA 071</b>		2.0 Platform	55	04.75-09.83		<b>KA 072</b>
<b>KA 071</b>		2.4 Bus	66	12.82-07.92		<b>KA 072</b>
<b>KA 071</b>		2.4 4WD Bus	66	12.82-07.92		<b>KA 072</b>
<b>KA 071</b>		2.4i Bus; 2.4i Platform	69	01.93-06.96		<b>KA 072</b>
<b>KA 071</b>		2.4 D Bus; 2.4 D Platform	51	07.90-06.96		<b>KA 072</b>
<b>KA 071</b>		2.4 D Bus; 2.4 D Platform	55	12.78-07.92		<b>KA 072</b>
<b>KA 071</b>		2.4 D 4WD Bus; 2.4 TD 4WD Bus	55-75	08.78-03.86		<b>KA 072</b>
<b>KA 071</b>		2.4 TD Bus; 2.4 TD Platform	68-75	02.86-06.96		<b>KA 072</b>
<b>KA 071</b>		2.4 TD Platform	75	12.82-09.93		<b>KA 072</b>
<b>LT 28-35 II</b>						
<b>KA 273</b>		2.3 Bus	105	05.96-		
<b>KA 273</b>		2.5 SDI Bus; 2.5 TDI Bus	55-80	05.96-		
<b>KA 273</b>		2.3 Bus; 2.3 Platform	105	05.96-		
<b>KA 273</b>		2.5 SDI Bus; 2.5 SDI Platform; 2.5 TDI Bus; 2.5 TDI Platform; 2.8 TDI Bus; 2.8 TDI Platform	55-116	05.96-		
<b>LUPU (6X)</b>						
<b>KF 181</b>		1.0; 1.4; 1.4 16V; 1.4 FSI; 1.6 GTI	37-92	09.98-07.05		<b>KV 284</b>
<b>KF 181</b>		1.0i	37-92	98-		<b>KA 069</b>
<b>KF 181</b>		1.2 TD, 1.4 D	37-92	98-		<b>KA 069</b>
<b>KV 285</b>		1.2 TDI	45	07.99-07.05		
<b>KF 181</b>		1.4 TDI; 1.7 SDI	44-55	09.98-07.05		<b>KV 284</b>

	<b>i</b>	<b>ENGINE</b>	<b>POWER (kW)</b>	<b>YEAR</b>	<b>i</b>	
Fersa KIT FRONT						Fersa KIT REAR
<b>VOLKSWAGEN</b>						
<b>LUPO (6X)</b>						
<b>KF 181</b>		1.4i, 1.6i 16V	44-55	98-		<b>KA 069</b>
<b>KF 181</b>		1.7 SDi	44-55	98-		<b>KA 069</b>
<b>NEW BEETLE</b>						
<b>KF 184</b>		1.4; 1.6; 1.8 T; 2.0; 2.3 V5; RSI 3.2	55-165	01.98-		<b>KV 194</b>
<b>KF 184</b>		1.9 TDI	66-74	01.98-		<b>KV 194</b>
<b>PASSAT (32,33)</b>						
<b>KF 095</b>		1.3 Hatchback; 1.3 Estate Car; 1.5 Hatchback; 1.5 Estate Car; 1.6 Hatchback; 1.6 Estate Car; 1.6i Estate Car	40-81	05.73-07.80		<b>KA 006</b>
<b>KF 095</b>		1.5 D Hatchback; 1.5 D Estate Car; 1.6 D Estate Car	37-40	02.77-07.80		<b>KA 006</b>
<b>PASSAT (32B)</b>						
<b>KF 095</b>		1.3 Hatchback; 1.3 Estate Car; 1.6 Limousine; 1.6 Hatchback; 1.6 Estate Car; 1.8 Limousine; 1.8 Hatchback; 1.8 Estate Car	40-82	08.80-03.88		<b>KA 006</b>
<b>KF 095</b>		1.8 SYNCRO Estate Car	66	01.86-03.88		<b>KF 095</b>
<b>KF 095</b>		1.9 Hatchback; 1.9 Estate Car; 2.0 Hatchback; 2.0 Estate Car	85	01.81-03.88		<b>KA 006</b>
<b>KF 095</b>		2.0 SYNCRO Estate Car	85	05.84-03.88		<b>KF 095</b>
<b>KF 095</b>		2.1 Hatchback; 2.2 Limousine; 2.2 Hatchback; 2.2 Estate Car	85-100	01.81-03.88		<b>KA 006</b>
<b>KF 095</b>		2.2 SYNCRO Estate Car	88	08.85-03.88		<b>KF 095</b>
<b>KF 095</b>		1.6 D Hatchback; 1.6 D Estate Car; 1.6 TD Limousine; 1.6 TD Hatchback; 1.6 TD Estate Car	40-59	08.80-03.88		<b>KA 006</b>
<b>PASSAT (35I)</b>						
<b>KF 095</b>	CH. --> 32-J-299999	1.6 Limousine; 1.6 Estate Car; 1.8 Limousine; 1.8 Estate Car; 1.8 16V Limousine; 1.8 16V Estate Car	53-100	02.88-05.97		
<b>KF 182</b>	CH. 31-J-000001 -->	1.6 Limousine; 1.6 Estate Car; 1.8 Limousine; 1.8 Estate Car; 1.8 16V Limousine; 1.8 16V Estate Car	53-100	02.88-05.97		
		1.6 Limousine; 1.6 Estate Car; 1.8 Limousine; 1.8 Estate Car; 1.8 16V Limousine; 1.8 16V Estate Car	53-100	02.88-05.97		<b>KA 006</b>
<b>KF 182</b>		1.8 G60 SYNCRO Limousine; 1.8 G60 SYNCRO Estate Car	118	08.88-05.97		
		1.8 G60 SYNCRO Limousine; 1.8 G60 SYNCRO Estate Car	118	08.88-05.97	CH. --> 31-M-367758	<b>KF 095</b>
		1.8 G60 SYNCRO Limousine; 1.8 G60 SYNCRO Estate Car	118	08.88-05.97	CH. 31-M-367759 -->	<b>KF 182</b>
<b>KF 095</b>	CH. --> 32-J-299999	2.0 Limousine; 2.0 Estate Car; 2.0 16V Estate Car; 2.0 16V GT Limousine	79-100	08.88-05.97		
<b>KF 182</b>	CH. 31-J-000001 -->	2.0 Limousine; 2.0 Estate Car; 2.0 16V Estate Car; 2.0 16V GT Limousine	79-100	08.88-05.97		
		2.0 Limousine; 2.0 Estate Car; 2.0 16V Estate Car; 2.0 16V GT Limousine	79-100	08.88-05.97		<b>KA 006</b>
<b>KF 182</b>		2.0 SYNCRO Limousine; 2.0 SYNCRO Estate Car	85	10.90-05.97		
		2.0 SYNCRO Limousine; 2.0 SYNCRO Estate Car	85	10.90-05.97	CH. --> 31-M-367758	<b>KF 095</b>
		2.0 SYNCRO Limousine; 2.0 SYNCRO Estate Car	85	10.90-05.97	CH. 31-M-367759 -->	<b>KF 182</b>
<b>KF 183</b>	CH. 3A-V-300000 -->	2.0 16V Limousine; 2.0 16V Estate Car	110	01.94-05.97		<b>KA 006</b>
<b>KF 183</b>		2.8 VR6 Limousine; 2.8 VR6 Estate Car	128	06.91-05.97		<b>KA 006</b>
<b>KF 183</b>		2.9 VR6 SYNCRO Estate Car	135	01.94-05.97		<b>KF 182</b>
<b>KF 182</b>		1.6 TD Limousine; 1.6 TD Estate Car; 1.9 D Limousine; 1.9 D Estate Car; 1.9 TD Limousine; 1.9 TD Estate Car; 1.9 TDI Limousine; 1.9 TDI Estate Car	50-66	08.88-05.97		<b>KA 006</b>
<b>KF 183</b>		1.9 TDI Limousine	81	03.96-08.96		<b>KV 276</b>
<b>KF 182</b>		1.9 TDI Estate Car	81	03.96-05.97		<b>KA 006</b>
<b>PASSAT (3B2,3B5)</b>						
<b>KF 096</b>		1.6 Limousine; 1.6 Estate Car	74	10.96-11.00		<b>KV 276</b>
<b>KF 096</b>		1.8 Limousine; 1.8 Estate Car	85	01.97-11.00		<b>KV 276</b>
<b>KF 096</b>		1.8 20V Limousine; 1.8 20V Estate Car	92	10.96-11.00		<b>KV 276</b>
<b>KF 096</b>		1.8 4motion Limousine; 1.8 4motion Estate Car	92	10.96-11.00		<b>KF 098</b>
<b>KF 096</b>		1.8 T 20V Limousine; 1.8 T 20V Estate Car	110	10.96-11.00		<b>KV 276</b>
<b>KF 096</b>	[M.T]	2.3 VR5 Limousine; 2.3 VR5 Estate Car	110	10.96-11.00		<b>KV 276</b>

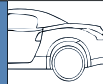
	<b>i</b>	<b>ENGINE</b>	<b>POWER (kW)</b>	<b>YEAR</b>	<b>i</b>	
Fersa KIT FRONT						Fersa KIT REAR
<b>VOLKSWAGEN</b>						
<b>PASSAT (3B2,3B5)</b>						
<b>KF 098</b>	[A.T]	2.3 VR5 Limousine; 2.3 VR5 Estate Car	110	10.96-11.00		<b>KV 276</b>
<b>KF 096</b>		2.3 VR5 4motion Limousine; 2.3 VR5 4motion Estate Car	110	10.97-11.00		<b>KF 096</b>
<b>KF 098</b>		2.8 V6 Limousine; 2.8 V6 Estate Car	132-140	05.97-11.00		<b>KV 276</b>
<b>KF 098</b>		2.8 V6 4motion Limousine; 2.8 V6 4motion Estate Car	140	09.99-11.00		<b>KF 096</b>
<b>KF 098</b>		2.8 V6 4motion Limousine; 2.8 V6 4motion Estate Car	140	09.99-11.00		
<b>KF 098</b>		2.8 30V Limousine; 2.8 30V Estate Car	142	08.96-11.00		<b>KV 276</b>
<b>KF 098</b>		2.8 V6 4motion Limousine; 2.8 V6 4motion Estate Car	142	10.96-11.00		<b>KF 096</b>
<b>KF 096</b>		1.9 TDI Limousine; 1.9 TDI Estate Car	66	10.96-11.00		<b>KV 276</b>
<b>KF 098</b>		1.9 TDI Limousine; 1.9 TDI Estate Car	81	10.96-11.00		<b>KV 276</b>
<b>KF 098</b>		1.9 TDI 4motion Limousine; 1.9 TDI 4motion Estate Car	81	10.96-11.00		<b>KF 096</b>
<b>KF 096</b>	CH. --> 3B-Y-390000 / [5-M.T]	1.9 TDI Limousine; 1.9 TDI Estate Car	85	08.98-11.00		<b>KV 276</b>
<b>KF 098</b>	CH. 3B-Y-390001 --> / [5-M.T]	1.9 TDI Limousine; 1.9 TDI Estate Car	85	08.98-11.00		<b>KV 276</b>
<b>KF 098</b>	[6-M.T]	1.9 TDI Limousine; 1.9 TDI Estate Car	85	08.98-11.00		<b>KV 276</b>
<b>KF 098</b>		1.9 TDI 4motion Limousine; 1.9 TDI 4motion Estate Car	85	08.99-11.00		<b>KF 096</b>
<b>KF 098</b>		2.5 TDI Limousine; 2.5 TDI Estate Car	110	07.98-11.00		<b>KV 276</b>
<b>KF 098</b>		2.5 TDI 4motion Limousine; 2.5 TDI 4motion Estate Car	110	12.98-11.00		<b>KF 096</b>
<b>KF 098</b>		2.5 TDI 4motion Limousine; 2.5 TDI 4motion Estate Car	110	12.98-11.00		
<b>PASSAT (3B3,3B6)</b>						
<b>KF 096</b>		1.6 Limousine; 1.6 Estate Car	75	11.00-05.05		<b>KV 276</b>
<b>KF 096</b>	[M.T]	1.8 T 20V Limousine; 1.8 T 20V Estate Car	110	11.00-05.05		<b>KV 276</b>
<b>KF 098</b>	[A.T]	1.8 T 20V Limousine; 1.8 T 20V Estate Car	110	11.00-05.05		<b>KV 276</b>
<b>KF 098</b>		1.8 T Limousine	125	02.01-05.05		<b>KV 276</b>
<b>KF 096</b>		2.0 4motion Limousine; 2.0 4motion Estate Car	85	11.00-05.05		
<b>KF 096</b>		2.0 Limousine; 2.0 Estate Car	85-96	11.00-05.05		<b>KV 276</b>
		2.0 Limousine; 2.0 Estate Car	85-96	11.00-05.05		<b>KV 276</b>
<b>KF 098</b>		2.3 VR5 Limousine; 2.3 VR5 Estate Car	125	11.00-05.05		<b>KV 276</b>
<b>KF 098</b>		2.3 V5 4motion Limousine; 2.3 VR5 4motion Estate Car; 2.8 4motion Limousine;	125-202	11.00-05.05		
<b>KF 096</b>	[M.T]	1.9 TDI Limousine; 1.9 TDI Estate Car	74	11.00-05.05		
<b>KF 098</b>	[A.T]	1.9 TDI Limousine; 1.9 TDI Estate Car	74	11.00-05.05		
		1.9 TDI Limousine; 1.9 TDI Estate Car	74	11.00-05.05		<b>KV 276</b>
<b>KF 098</b>		1.9 TDI Limousine; 1.9 TDI Estate Car	96	11.00-05.05		<b>KV 276</b>
<b>KF 098</b>		1.9 TDI 4motion Limousine; 1.9 TDI 4motion Estate Car	96	11.00-05.05		
<b>KF 098</b>		2.0 TDI Limousine; 2.0 TDI Estate Car; 2.5 TDI Limousine; 2.5 TDI Estate Car	100-120	11.00-05.05		<b>KV 276</b>
<b>KF 098</b>		2.5 TDI 4motion Limousine; 2.5 TDI 4motion Estate Car	110-132	11.00-05.05		
<b>POLO (6KV2)</b>						
<b>KF 182</b>		1.4 60; 1.4 16V 75	44-55	12.95-09.01		
		1.4 60; 1.4 16V 75	44-55	12.95-09.01	CH. --> 6K-Y-502794	<b>KA 006</b>
		1.4 60; 1.4 16V 75	44-55	12.95-09.01	CH. 6K-Y-502795 -->	<b>KV 284</b>
<b>KF 182</b>		1,675	55	11.95-09.97		<b>KA 006</b>
<b>KF 182</b>		1.6 75; 1.6 100; 1.8 90; 2.0	55-85	11.95-09.01		
<b>KF 182</b>		1.6 75; 1.6 100; 1.8 90; 2.0	55-85	11.95-09.01	CH. --> 6K-Y-502794	<b>KA 006</b>
<b>KF 182</b>		1.6 75; 1.6 100; 1.8 90; 2.0	55-85	11.95-09.01	CH. 6K-Y-502795 -->	<b>KV 284</b>
<b>KF 182</b>		1.7 SDI q57; 1.9 SDI 50; 1.9 SDI 64; 1.9 TDI 90; 1.9 TDI 110	42-81	12.95-09.01	CH. --> 6K-Y-502794	<b>KA 006</b>
<b>KF 182</b>		1.7 SDI q57; 1.9 SDI 50; 1.9 SDI 64; 1.9 TDI 90; 1.9 TDI 110	42-81	12.95-09.01	CH. 6K-Y-502795 -->	<b>KV 284</b>
<b>POLO (6KV5)</b>						
<b>KF 182</b>		1.4; 1.4 16V; 1.6; 1.8	40-74	05.97-09.01	CH. --> 6K-Y-502794	<b>KA 006</b>
<b>KF 182</b>		1.4; 1.4 16V; 1.6; 1.8	40-74	05.97-09.01	CH. 6K-Y-502795 -->	<b>KV 284</b>



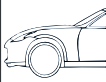
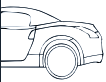

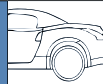
	<b>i</b>	<b>ENGINE</b>	<b>POWER (kW)</b>	<b>YEAR</b>	<b>i</b>	
Fersa KIT FRONT						Fersa KIT REAR
<b>VOLKSWAGEN</b>						
<b>POLO (6KV5)</b>						
<b>KF 182</b>		1.7 SDI; 1.9 SDI; 1.9 TDI	42-81	05.97-09.01	CH. --> 6K-Y-502794	<b>KA 006</b>
<b>KF 182</b>		1.7 SDI; 1.9 SDI; 1.9 TDI	42-81	05.97-09.01	CH. 6K-Y-502795 -->	<b>KV 284</b>
<b>POLO (6N1)</b>						
<b>KF 181</b>		1.0 50 Hatchback	37	09.96-10.99	CH. --> 6N-XY379991	<b>KA 006</b>
<b>KF 181</b>		1.0 50 Hatchback	37	09.96-10.99	CH. 6N-XY379992 -->	<b>KV 284</b>
<b>KF 182</b>		1.0 Bus	33	10.94-12.99	CH. --> 6K-X-610000	<b>KA 006</b>
<b>KF 182</b>		1.0 Bus	33	10.94-12.99	CH. --> 6K-X-610001	<b>KV 284</b>
<b>KF 181</b>		1.0 45 Hatchback; 1.3 55 Hatchback; 1.4 55 Hatchback	33-40	10.94-10.99	CH. --> 6N-XY379991	<b>KA 006</b>
<b>KF 181</b>		1.0 45 Hatchback; 1.3 55 Hatchback; 1.4 55 Hatchback	33-40	10.94-10.99	CH. 6N-XY379992 -->	<b>KV 284</b>
<b>KF 182</b>		1.4 Bus	44	05.98-12.99	CH. --> 6N-XY379991	<b>KA 006</b>
<b>KF 182</b>		1.4 Bus	44	05.98-12.99	CH. 6N-XY379992 -->	<b>KV 284</b>
<b>KF 181</b>		1.4 60 Hatchback; 1.4 100 Hatchback; 1.6 75 Hatchback; 1.6 16V GTI 120 Hatchback	44-88	10.94-10.99	CH. --> 6N-XY379991	<b>KA 006</b>
<b>KF 181</b>		1.4 60 Hatchback; 1.4 100 Hatchback; 1.6 75 Hatchback; 1.6 16V GTI 120 Hatchback	44-88	10.94-10.99	CH. 6N-XY379992 -->	<b>KV 284</b>
<b>KF 181</b>		1.7 SDI Hatchback	42	04.97-10.99	CH. --> 6N-XY379991	<b>KA 006</b>
<b>KF 181</b>		1.7 SDI Hatchback	42	04.97-10.99	CH. 6N-XY379992 -->	<b>KV 284</b>
<b>KF 182</b>		1.7 SDI Bus	44	08.97-12.99	CH. --> 6K-X-610000	<b>KA 006</b>
<b>KF 182</b>		1.7 SDI Bus	44	08.97-12.99	CH. --> 6K-X-610001	<b>KV 284</b>
<b>KF 181</b>		1.7 SDI 60 Hatchback	44	08.97-10.99	CH. --> 6N-XY379991	<b>KA 006</b>
<b>KF 181</b>		1.7 SDI 60 Hatchback	44	08.97-10.99	CH. 6N-XY379992 -->	<b>KV 284</b>
<b>KF 182</b>		1.9 D Bus	47	10.94-12.99	CH. --> 6K-X-610000	<b>KA 006</b>
<b>KF 182</b>		1.9 D Bus	47	10.94-12.99	CH. --> 6K-X-610001	<b>KV 284</b>
<b>KF 181</b>		1.9 D 64 Hatchback	47	10.94-10.99	CH. --> 6N-XY379991	<b>KA 006</b>
<b>KF 181</b>		1.9 D 64 Hatchback	47	10.94-10.99	CH. 6N-XY379992 -->	<b>KV 284</b>
<b>KF 182</b>		1.9 SDI Bus	47	07.96-12.99	CH. --> 6N-XY379991	<b>KA 006</b>
<b>KF 182</b>		1.9 SDI Bus	47	07.96-12.99	CH. 6N-XY379992 -->	<b>KV 284</b>
<b>KF 181</b>		1.9 SDI 64 Hatchback	47	07.96-10.99	CH. --> 6N-XY379991	<b>KA 006</b>
<b>KF 181</b>		1.9 SDI 64 Hatchback	47	07.96-10.99	CH. 6N-XY379992 -->	<b>KV 284</b>
<b>POLO (6N2)</b>						
<b>KF 181</b>		1.0; 1.4	37-40	10.99-09.01	CH. --> 6N-XY379991	<b>KA 006</b>
<b>KF 181</b>		1.0; 1.4	37-40	10.99-09.01	CH. 6N-XY379992 -->	<b>KV 284</b>
<b>KF 181</b>		1.4	44	10.99-09.01	CH. --> 6N-XY379991	<b>KA 006</b>
<b>KF 181</b>		1.4	44	10.99-09.01	CH. 6N-XY379992 -->	<b>KV 284</b>
<b>KF 181</b>		1.4 16V; 1.6 16V GTI	55-92	10.99-09.01	CH. --> 6N-XY379991	<b>KA 006</b>
<b>KF 181</b>		1.4 16V; 1.6 16V GTI	55-92	10.99-09.01	CH. 6N-XY379992 -->	<b>KV 284</b>
<b>KF 181</b>		1.4 TDI; 1.7 SDI; 1.9 D; 1.9 SDI	44-55	10.99-09.01	CH. --> 6N-XY379991	<b>KA 006</b>
<b>KF 181</b>		1.4 TDI; 1.7 SDI; 1.9 D; 1.9 SDI	44-55	10.99-09.01	CH. 6N-XY379992 -->	<b>KV 284</b>
<b>POLO (86)</b>						
<b>KF 180</b>		0.9; 1.1; 1.3	29-44	03.75-09.81		<b>KA 006</b>
<b>POLO (86C)</b>						
<b>KF 180</b>		0.9 Hatchback; 1.0 Limousine; 1.0 Hatchback; 1.0 Coupe	29-33	10.81-09.94		<b>KA 006</b>
<b>KF 182</b>		1.0 Bus	33	08.92-07.94		
<b>KF 182</b>		1.0 Bus	33	08.92-07.94	CH. --> 6K-X-610000	<b>KA 006</b>
<b>KF 182</b>		1.0 Bus	33	08.92-07.94	CH. --> 6K-X-610001	<b>KV 284</b>
<b>KF 180</b>		1.0 Hatchback; 1.0 Coupe; 1.1 Hatchback; 1.1 Coupe; 1.3; 1.3 Hatchback; 1.3 Coupe	33-40	10.81-09.94		<b>KA 006</b>
<b>KF 180</b>		1.0 Hatchback; 1.0 Coupe; 1.1 Hatchback; 1.1 Coupe; 1.3; 1.3 Hatchback; 1.3 Coupe	33-40	10.81-09.94		
<b>KF 182</b>		1.3 Bus	40	08.92-07.94		
<b>KF 182</b>		1.3 Bus	40	08.92-07.94	CH. --> 6K-X-610000	<b>KA 006</b>

	<b>i</b>	<b>ENGINE</b>	<b>POWER (kW)</b>	<b>YEAR</b>	<b>i</b>	
Fersa KIT FRONT						Fersa KIT REAR
<b>VOLKSWAGEN</b>						
<b>POLO (86C)</b>						
<b>KF 182</b>		1.3 Bus	40	08.92-07.94	CH. --> 6K-X-610001	<b>KV 284</b>
<b>KF 180</b>		1.3 Limousine; 1.3 Hatchback; 1.3 Coupe; 1.3 G40 Coupe	40-85	10.81-09.94		<b>KA 006</b>
<b>KF 180</b>		1.3 Limousine; 1.3 Hatchback; 1.3 Coupe; 1.3 G40 Coupe	40-85	10.81-09.94		
<b>KF 180</b>		1.3 D Limousine; 1.3 D Hatchback; 1.3 D Coupe; 1.4 D Limousine; 1.4 D Hatchback; 1.4 D Coupe	33-35	08.86-09.94		<b>KA 006</b>
<b>KF 180</b>		1.3 D Limousine; 1.3 D Hatchback; 1.3 D Coupe; 1.4 D Limousine; 1.4 D Hatchback; 1.4 D Coupe	33-35	08.86-09.94		
<b>KF 182</b>		1.4 D Bus	35	08.92-07.94		
<b>KF 182</b>		1.4 D Bus	35	08.92-07.94	CH. --> 6K-X-610000	<b>KA 006</b>
<b>KF 182</b>		1.4 D Bus	35	08.92-07.94	CH. --> 6K-X-610001	<b>KV 284</b>
<b>POLO (9N )</b>						
<b>KV 287</b>		1.2; 1.4 16V; 1.4 FSI	40-74	10.01-		<b>KV 286</b>
<b>KV 287</b>		1.4 TDI; 1.9 SDI; 1.9 TDI	47-74	10.01-		<b>KV 286</b>
<b>SANTANA (32B)</b>						
<b>KF 185</b>		1.3,1.6,1.6D,1.8,1.9,2.0,2.1	44-85	83-85		<b>KA 069</b>
<b>KF 095</b>		1.3; 1.6; 1.8; 1.9; 2.0; 2.1	44-85	08.81-12.84		<b>KA 006</b>
<b>KF 095</b>		1.6 D; 1.6 TD	40-51	08.81-12.84		<b>KA 006</b>
<b>KF 185</b>		1.6 TD, 1.8,2.0	40-51	83-85		<b>KA 069</b>
<b>KF 185</b>		1.3,1.6,1.6D,1.8,1.9,2.0,2.1	44-85	83-85		<b>KA 069</b>
<b>SCIROCCO (53)</b>						
<b>KF 179</b>		1.1; 1.3; 1.4; 1.5; 1.6	37-81	02.74-07.80		<b>KA 006</b>
<b>SCIROCCO (53B)</b>						
<b>KF 179</b>		1.3; 1.4; 1.6; 1.8; 1.8 16V	44-102	08.80-07.92		<b>KA 006</b>
<b>SHARAN</b>						
<b>KF 240</b>		1.8 T 20V; 2.0; 2.0 CL; 2.8 VR6; 2.8 VR6 24V	85-150	09.95-		<b>KF 241</b>
<b>KF 240</b>		2.8 V6 24V 4motion; 2.8 VR6 SYNCRO	128-150	11.96-		<b>KF 240</b>
<b>KF 240</b>		1.9 TDI	66-110	09.95-		<b>KF 241</b>
<b>KF 240</b>		1.9 TDI 4motion	85	04.00-		<b>KF 240</b>
<b>KF 240</b>		2.0 TDI	103	11.05-		<b>KF 241</b>
<b>TARO</b>						
<b>KA 070</b>		1.8; 2.2	61-69	04.89-09.94		
<b>KA 070</b>		2.4 D	58-61	06.89-03.97		
<b>TRANSPORTER II</b>						
		1.6 Platform	37	08.68-07.79		<b>KC 256</b>
		1.6 Bus; 1.6 Bus	37	08.70-04.79		<b>KC 256</b>
		1.7 Bus; 1.7 Bus; 1.8 Bus; 1.8 Bus; 2.0 Bus; 2.0 Bus	49-51	08.71-07.79		<b>KC 256</b>
<b>TRANSPORTER III</b>						
		1.6 Bus; 1.6 Bus	37	05.79-12.82		<b>KC 256</b>
		1.9 Bus; 1.9 Bus; 1.9 Platform	44-66	08.82-07.92		<b>KC 256</b>
		1.9 SYNCRO Bus; 1.9 SYNCRO Bus; 1.9 SYNCRO Platform	57	11.84-07.92		<b>KC 256</b>
		1.9 Bus	66	08.83-02.89		<b>KC 256</b>
		2.0 Bus	51	05.79-12.82		<b>KC 256</b>
		2.0 Bus	51	05.79-04.86		<b>KC 256</b>
		2.0 Platform	51	05.79-04.86		<b>KC 256</b>
		2.1 Bus	64	10.86-07.92		<b>KC 256</b>
		2.1 SYNCRO Bus	64	10.86-07.92		<b>KC 256</b>
		2.1 Bus; 2.1 Bus; 2.1 Platform; 2.1i Bus; 2.1i Bus; 2.1i Platform	68-82	08.85-07.92		<b>KC 256</b>
		2.1 SYNCRO Bus; 2.1 SYNCRO Bus; 2.1 SYNCRO Platform	70-82	08.85-07.92		<b>KC 256</b>
		1.6 D Bus; 1.6 D Bus; 1.6 D Platform	37	01.81-07.87		<b>KC 256</b>
		1.6 TD Bus; 1.6 TD Bus; 1.6 TD Platform	51	08.84-07.92		<b>KC 256</b>

	<b>i</b>	<b>ENGINE</b>	<b>POWER (kW)</b>	<b>YEAR</b>	<b>i</b>	
Fersa KIT FRONT						Fersa KIT REAR
<b>VOLKSWAGEN</b>						
<b>TRANSPORTER III</b>						
		1.6 TD SYNCRO Bus; 1.6 TD SYNCRO Bus; 1.6 TD SYNCRO Platform	51	03.86-07.92		<b>KC 256</b>
		1.7 D Bus; 1.7 D Bus; 1.7 D Platform	42	10.86-07.92		<b>KC 256</b>
<b>TRANSPORTER IV</b>						
<b>KF 233</b>	CH. 28DD-007273 -->	1.8 Bus	49	12.90-07.92	800 * 1200[kg]	<b>KF 233</b>
<b>KF 233</b>	CH. --> 70-T-199000	2.0 Bus; 2.0 Bus; 2.0 Platform; 2.5 Bus; 2.5 Bus; 2.5 Platform; 2.5 SYNCRO Bus; 2.5 SYNCRO Bus; 2.5 SYNCRO Platform; 2.8 Bus	62-103	07.90-04.03	800 * 1200[kg]	<b>KF 233</b>
<b>KF 233</b>	CH. 70-T-200001 -->	2.0 Bus; 2.0 Bus; 2.0 Platform; 2.5 Bus; 2.5 Bus; 2.5 Platform; 2.5 SYNCRO Bus; 2.5 SYNCRO Bus; 2.5 SYNCRO Platform; 2.8 Bus	62-103	07.90-04.03	800 * 1200[kg]	<b>KF 233</b>
<b>KF 233</b>	CH. --> 70-T-199000	1.9 D Bus; 1.9 D Bus; 1.9 D Platform; 1.9 TD Bus; 1.9 TD Bus; 1.9 TD Platform; 2.4 D Bus; 2.4 D Bus; 2.4 D Platform; 2.4 D SYNCRO Bus; 2.4 D SYNCRO Bus; 2.4 D SYNCRO Platform; 2.5 TDI Bus; 2.5 TDI Bus; 2.5 TDI Platform; 2.5 TDI (7DW) Bus;	44-111	07.90-04.03	800 * 1200[kg]	<b>KF 233</b>
<b>KF 233</b>	CH. 70-T-200001 -->	1.9 D Bus; 1.9 D Bus; 1.9 D Platform; 1.9 TD Bus; 1.9 TD Bus; 1.9 TD Platform; 2.4 D Bus; 2.4 D Bus; 2.4 D Platform; 2.4 D SYNCRO Bus; 2.4 D SYNCRO Bus; 2.4 D SYNCRO Platform; 2.5 TDI Bus; 2.5 TDI Bus; 2.5 TDI Platform; 2.5 TDI (7DW) Bus;	44-111	07.90-04.03	800 * 1200[kg]	<b>KF 233</b>
<b>KF 233</b>	CH. --> 70-T-199000	2.5 TDI SYNCRO Bus; 2.5 TDI SYNCRO Platform	75	09.95-04.03	800 * 1200[kg]	<b>KF 233</b>
<b>KF 233</b>	CH. 70-T-200001 -->	2.5 TDI SYNCRO Bus; 2.5 TDI SYNCRO Platform	75	09.95-04.03	800 * 1200[kg]	<b>KF 233</b>
<b>KF 233</b>		2.5 TDI SYNCRO Platform	75	05.98-04.03	800 * 1200[kg]	<b>KF 233</b>
<b>KF 233</b>		2.5 TDI Bus	111	09.00-04.03	800 * 1200[kg]	<b>KF 233</b>
<b>VENTO</b>						
<b>KF 182</b>		1.4; 1.6; 1.8; 2.0	40-85	11.91-09.98	DRUM BRAKE	<b>KA 006</b>
<b>KF 182</b>		1.4,1.6,1.8,1.9D,TD	40-85	95-		<b>KA 069</b>
<b>KF 183</b>		2.0,2.0 16V,2.8 VR6	40-85	92-		<b>KA 069</b>
<b>KF 183</b>		2.8 VR6	128	01.92-09.98	DRUM BRAKE	<b>KA 006</b>
<b>KF 182</b>		1.9 D; 1.9 SDI; 1.9 TD; 1.9 TDI	47-81	11.91-09.98	DRUM BRAKE	<b>KA 006</b>
<b>VOLVO</b>						
<b>66</b>						
<b>KA 068</b>		66 DL 1.1; 66 GL 1.3	33-42	08.75-11.79		
<b>140</b>						
		1.8 S Limousine; 2.0 S Limousine	74-85	07.67-08.75	CH. 343370 -->	<b>KA 211</b>
		1.8 S Limousine; 2.0 S Limousine	74-85	07.67-08.75	CH. 364569 -->	<b>KA 211</b>
		2.0 S Estate Car	85	09.73-02.75	CH. 169776 -->	<b>KA 211</b>
		2.0 Limousine	60	08.68-07.74	CH. 343370 -->	<b>KA 211</b>
		2.0 Limousine	60	08.68-07.74	CH. 364569 -->	<b>KA 211</b>
		2.0 S Estate Car	60	08.68-07.74	CH. 169776 -->	<b>KA 211</b>
		2.0 Limousine	70	08.71-07.72	CH. 343370 -->	<b>KA 211</b>
		2.0 Limousine	70	08.71-07.72	CH. 364569 -->	<b>KA 211</b>
		2.0 S Estate Car	73	08.72-07.73	CH. 169776 -->	<b>KA 211</b>
		2.0 S Limousine	74	11.68-09.72	CH. 343370 -->	<b>KA 211</b>
		2.0 S Limousine	74	11.68-09.72	CH. 364569 -->	<b>KA 211</b>
		2.0 S Estate Car	74	08.72-07.74	CH. 169776 -->	<b>KA 211</b>
		2.0 Limousine	91	09.70-04.75	CH. 343370 -->	<b>KA 211</b>
		2.0 Limousine	91	09.70-04.75	CH. 364569 -->	<b>KA 211</b>
		2.0 S Estate Car	91	08.72-07.73	CH. 169776 -->	<b>KA 211</b>
<b>164</b>						
		2.9; 2.9 E	96-118	08.68-07.74	CH. 081146 -->	<b>KA 211</b>

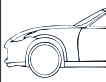
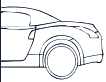

	<b>i</b>	<b>ENGINE</b>	<b>POWER (kW)</b>	<b>YEAR</b>	<b>i</b>	
Fersa KIT FRONT						Fersa KIT REAR
<b>VOLVO</b>						
<b>240</b>						
		2.0 Limousine	60-66	08.74-07.79		<b>KA 211</b>
		2.0 Limousine; 2.0 Estate Car	66-71	08.76-08.83		<b>KA 211</b>
		2.0 Limousine; 2.0 Estate Car	71-86	08.80-07.93		<b>KA 211</b>
		2.1 Limousine; 2.1 Estate Car	71-74	08.74-07.80		<b>KA 211</b>
		2.1 Limousine; 2.1 Estate Car	79-80	08.80-07.84		<b>KA 211</b>
		2.1 Limousine; 2.1 Estate Car	90	08.74-07.80		<b>KA 211</b>
		2.1 TURBO Limousine; 2.1 TURBO Estate Car; 2.3 Limousine; 2.3 Estate Car	81-114	08.80-07.93		<b>KA 211</b>
		2.3 Limousine; 2.7 GLT 6 Limousine; 2.7 GLT6 Estate Car	103-104	08.78-07.80		<b>KA 211</b>
		2.4 D Limousine; 2.4 D Estate Car	58	08.87-08.93		<b>KA 211</b>
		2.4 D Limousine; 2.4 D Estate Car	60	08.78-08.93		<b>KA 211</b>
<b>260</b>						
		2.7 Limousine	92	08.76-07.82		<b>KA 211</b>
		2.7 Limousine; 2.7 Estate Car	92-103	08.74-07.80		<b>KA 211</b>
		2.7 Estate Car	103	07.75-07.82		<b>KA 211</b>
		2.7 Coupe	103	08.77-07.78		<b>KA 211</b>
		2.7 Limousine; 2.7 Estate Car	109	08.78-07.82		<b>KA 211</b>
		2.8 Limousine; 2.8 Estate Car	95-114	08.80-07.82		<b>KA 211</b>
<b>340-360</b>						
<b>KA 068</b>		1.4	46-47	08.79-08.85		
<b>KA 068</b>		1.4	50	08.86-12.88		
<b>KA 068</b>		1.4	51	08.75-07.83		
<b>KA 068</b>		1.4	51	08.87-07.88		
<b>KA 068</b>		1.4	52-53	08.83-07.86		
<b>KA 068</b>		1.7	59	08.85-07.91		
<b>KA 068</b>		2.0	65-70	08.80-07.84		
<b>KA 068</b>		2.0	75-77	08.84-07.90		
<b>KA 068</b>		2.0	80-82	08.86-07.89		
<b>KA 068</b>		2.0	83-85	08.82-07.84		
<b>KA 068</b>		2.0	85-87	08.84-07.86		
<b>KA 068</b>		2.1	90	08.81-07.82		
<b>KA 068</b>		1.6 D	40	08.84-07.91		
<b>440</b>						
<b>KF 175</b>	CH. --> 205699	1.6; 1.7	61-64	09.88-12.96	<b>ABS</b>	<b>KV 178</b>
<b>KF 176</b>	CH. 205700 -->	1.6; 1.7	61-64	09.88-12.96	<b>ABS</b>	<b>KV 178</b>
<b>KF 175</b>		1.7	70	08.88-07.89	<b>ABS</b>	<b>KV 178</b>
<b>KF 175</b>	CH. --> 205699	1.7; 1.7 TURBO	75-88	08.88-12.96	<b>ABS</b>	<b>KV 178</b>
<b>KF 176</b>	CH. 205700 -->	1.7; 1.7 TURBO	75-88	08.88-12.96	<b>ABS</b>	<b>KV 178</b>
<b>KF 176</b>		1.7 TURBO; 1.8; 2.0	66-90	01.91-12.96	<b>ABS</b>	<b>KV 178</b>
<b>KF 176</b>		1.9 TD	66	07.94-12.96	<b>ABS</b>	<b>KV 178</b>
<b>460</b>						
<b>KF 176</b>		1.6	61	07.92-07.96	<b>ABS</b>	<b>KV 178</b>
<b>KF 175</b>	CH. --> 205699	1.7; 1.7 TURBO	64-88	09.88-07.96	<b>ABS</b>	<b>KV 178</b>
<b>KF 176</b>	CH. 205700 -->	1.7; 1.7 TURBO	64-88	09.88-07.96	<b>ABS</b>	<b>KV 178</b>
<b>KF 176</b>		1.7 TURBO; 1.8; 2.0	66-90	01.91-07.96	<b>ABS</b>	<b>KV 178</b>
<b>KF 176</b>		1.9 TD	66	07.94-07.96	<b>ABS</b>	<b>KV 178</b>
<b>480</b>						
<b>KF 175</b>		1.7	70	08.87-07.89	<b>ABS</b>	<b>KV 178</b>
<b>KF 175</b>	--> 12.90	1.7	75	08.89-07.96	<b>ABS</b>	<b>KV 178</b>
<b>KF 176</b>	01.91 -->	1.7	75	08.89-07.96	<b>ABS</b>	<b>KV 178</b>

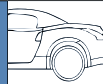
	<b>i</b>	<b>ENGINE</b>	<b>POWER (kW)</b>	<b>YEAR</b>	<b>i</b>	
Fersa KIT FRONT						Fersa KIT REAR
<b>VOLVO</b>						
<b>480</b>						
<b>KF 175</b>		1.7	78-80	04.86-07.89	<b>ABS</b>	<b>KV 178</b>
<b>KF 175</b>	--> 12.90	1.7 TURBO	88	08.87-07.96	<b>ABS</b>	<b>KV 178</b>
<b>KF 176</b>	01.91 -->	1.7 TURBO	88	08.87-07.96	<b>ABS</b>	<b>KV 178</b>
<b>KF 176</b>		1.7 TURBO; 2.0	81-90	01.91-07.96	<b>ABS</b>	<b>KV 178</b>
<b>740</b>						
		2.0 Estate Car	82	08.89-07.91		<b>KA 212</b>
		2.0 Limousine; 2.0 Estate Car; 2.3 Limousine; 2.3 Estate Car	83-89	08.84-07.92	01.89 -->	<b>KA 212</b>
		2.0 Limousine; 2.0 Estate Car; 2.3 Limousine; 2.3 Estate Car	83-89	08.84-07.92		<b>KA 211</b>
		2.0 Limousine; 2.0 Estate Car; 2.3 Limousine; 2.3 Estate Car	83-89	08.84-07.92	01.86--> / --> 12.88	<b>KA 212</b>
		2.0 Limousine; 2.0 Estate Car; 2.3 Limousine; 2.3 Estate Car	83-89	08.84-07.92	12.85 -->	<b>KA 212</b>
		2.3 Limousine; 2.3 Estate Car	85	08.87-07.92	01.89 -->	<b>KA 212</b>
		2.3 Limousine; 2.3 Estate Car	85	08.87-07.92		<b>KA 211</b>
		2.3 Limousine; 2.3 Estate Car	85	08.87-07.92	--> 12.88	<b>KA 212</b>
		2.3 Limousine	86	08.86-07.88		<b>KA 211</b>
		2.3 Limousine	86	08.86-07.88		<b>KA 212</b>
		2.3 Limousine	95	08.83-07.84		<b>KA 212</b>
		2.3 Limousine; 2.3 Estate Car	96	08.84-07.88	12.85 -->	<b>KA 212</b>
		2.3 Limousine; 2.3 Estate Car	96	08.84-07.88	01.86 -->	<b>KA 211</b>
		2.3 Limousine; 2.3 Estate Car	96	08.84-07.88	01.86 -->	<b>KA 212</b>
		2.3 Limousine	100	08.88-07.90		<b>KA 211</b>
		2.3 Limousine	100	08.88-07.90	--> 12.88	<b>KA 212</b>
		2.3 Limousine	100	08.88-07.90	01.89 -->	<b>KA 212</b>
		2.3 Estate Car	100	08.89-07.90		<b>KA 212</b>
		2.3 Limousine	111	08.88-08.92		<b>KA 211</b>
		2.3 Limousine	111	08.88-08.92	--> 12.88	<b>KA 212</b>
		2.3 Limousine	111	08.88-08.92	01.89 -->	<b>KA 212</b>
		2.3 Estate Car	111	07.89-08.92		<b>KA 212</b>
		2.3 Limousine; 2.3 Estate Car	114	08.88-07.91	--> 12.88	<b>KA 211</b>
		2.3 Limousine; 2.3 Estate Car	114	08.88-07.91	--> 12.88	<b>KA 212</b>
		2.3 Limousine; 2.3 Estate Car	114	08.88-07.91	01.89 -->	<b>KA 212</b>
		2.3 Limousine; 2.3 Estate Car; 2.3 TURBO Limousine; 2.3 TURBO Estate Car	115-117	08.86-07.89	01.89 -->	<b>KA 212</b>
		2.3 Limousine; 2.3 Estate Car; 2.3 TURBO Limousine; 2.3 TURBO Estate Car	115-117	08.86-07.89	--> 12.88	<b>KA 211</b>
		2.3 Limousine; 2.3 Estate Car; 2.3 TURBO Limousine; 2.3 TURBO Estate Car	115-117	08.86-07.89	--> 12.88	<b>KA 212</b>
		2.3 TURBO Limousine; 2.3 TURBO Estate Car	121	08.89-07.90		<b>KA 212</b>
		2.3 TURBO Estate Car	134	08.85-07.88	12.85 -->	<b>KA 212</b>
		2.3 TURBO Estate Car	134	08.85-07.88	01.86 -->	<b>KA 211</b>
		2.3 TURBO Estate Car	134	08.85-07.88	01.86 -->	<b>KA 212</b>
		2.3 TURBO Limousine; 2.3 TURBO Estate Car	140	08.89-07.90		<b>KA 212</b>
		2.4 D Limousine	60	08.84-07.92	01.89 -->	<b>KA 212</b>
		2.4 D Limousine	60	08.84-07.92	12.85 -->	<b>KA 212</b>
		2.4 D Limousine	60	08.84-07.92		<b>KA 211</b>
		2.4 D Limousine	60	08.84-07.92	01.86--> / --> 12.88	<b>KA 212</b>
		2.4 D Estate Car	60	08.85-07.88	12.85 -->	<b>KA 212</b>
		2.4 D Estate Car	60	08.85-07.88	01.86 -->	<b>KA 211</b>
		2.4 D Estate Car	60	08.85-07.88	01.86 -->	<b>KA 212</b>
		2.4 D Limousine; 2.4 TD Estate Car	80-83	08.84-07.92	01.89 -->	<b>KA 212</b>
		2.4 D Limousine; 2.4 TD Estate Car	80-83	08.84-07.92	12.85 -->	<b>KA 212</b>
		2.4 D Limousine; 2.4 TD Estate Car	80-83	08.84-07.92	01.86--> / --> 12.88	<b>KA 211</b>

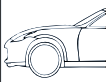
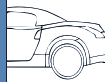
	<b>i</b>	<b>ENGINE</b>	<b>POWER (kW)</b>	<b>YEAR</b>	<b>i</b>	
Fersa KIT FRONT						Fersa KIT REAR
<b>VOLVO</b>						
<b>740</b>						
		2.4 D Limousine; 2.4 TD Estate Car	80-83	08.84-07.92	01.86--> / --> 12.88	<b>KA 212</b>
		2.4 TD Interc. Estate Car	90	08.86-07.88		<b>KA 211</b>
		2.4 TD Interc. Estate Car	90	08.86-07.88		<b>KA 212</b>
<b>760</b>						
		2.3 TURBO (704) Limousine	127	08.82-07.84		<b>KA 211</b>
		2.3 TURBO (704) Limousine	127	08.82-07.84		<b>KA 212</b>
		2.3 TURBO (704) Limousine	134	08.84-10.88		<b>KA 211</b>
		2.3 TURBO (704) Limousine	134	08.84-10.88		<b>KA 212</b>
		2.8 Limousine; 2.8 (765) Estate Car	95	01.82-12.87		<b>KA 211</b>
		2.8 Limousine; 2.8 (765) Estate Car	95	01.82-12.87		<b>KA 212</b>
		2.4 TD Interc. Estate Car	105	05.86-08.91	--> 12.87	<b>KA 211</b>
		2.4 TD Interc. Estate Car	105	05.86-08.91		<b>KA 212</b>
		2.8 (704) Limousine; 2.8 (764) Limousine	105-108	05.86-08.91	--> 12.88	<b>KA 211</b>
		2.8 (704) Limousine; 2.8 (764) Limousine	105-108	05.86-08.91	--> 12.88	<b>KA 212</b>
		2.8 (704) Limousine	115	08.81-07.88		<b>KA 211</b>
		2.8 (704) Limousine	115	08.81-07.88		<b>KA 212</b>
		2.8 (765) Estate Car	115	08.86-08.90	--> 12.87	<b>KA 211</b>
		2.8 (765) Estate Car	115	08.86-08.90		<b>KA 212</b>
		2.4 TD (704) Limousine	80	04.87-07.92	--> 12.88	<b>KA 211</b>
		2.4 TD (704) Limousine	80	04.87-07.92	--> 12.88	<b>KA 212</b>
		2.4 TD (704) Limousine	82	08.82-07.87		<b>KA 211</b>
		2.4 TD (704) Limousine	82	08.82-07.87		<b>KA 212</b>
		2.4 TD Interc. Limousine	85	08.87-07.92	--> 12.88	<b>KA 211</b>
		2.4 TD Interc. Limousine	85	08.87-07.92	--> 12.88	<b>KA 212</b>
		2.4 TD Interc. Estate Car	85	08.87-07.92	--> 12.87	<b>KA 211</b>
		2.4 TD Interc. Estate Car	85	08.87-07.92		<b>KA 212</b>
<b>780</b>						
		2.9	108	08.87-07.90		<b>KA 212</b>
		2.9	115	08.86-07.87		<b>KA 212</b>
<b>850</b>						
<b>KV 245</b>	CH. --> 219645	2.0 10V Limousine	93	08.94-12.96		<b>KV 234</b>
<b>KV 245</b>	CH. 219646 -->	2.0 10V Limousine	93	08.94-12.96		<b>KV 234</b>
<b>KV 245</b>	CH. --> 121428	2.0 10V Estate Car	93	08.94-12.96		<b>KV 234</b>
<b>KV 245</b>	CH. 121429 -->	2.0 10V Estate Car	93	08.94-12.96		<b>KV 234</b>
<b>KV 245</b>	01.94 --> / CH. --> 219645	2.0 Limousine	105	06.91-12.96	01.94 -->	<b>KV 234</b>
<b>KV 245</b>	CH. 219646 -->	2.0 Limousine	105	06.91-12.96	01.94 -->	<b>KV 234</b>
<b>KV 245</b>	01.94 --> / CH. --> 121428	2.0 Estate Car	105	02.93-12.96	01.94 -->	<b>KV 234</b>
<b>KV 245</b>	CH. 121429 -->	2.0 Estate Car	105	02.93-12.96	01.94 -->	<b>KV 234</b>
<b>KV 245</b>	01.94 --> / CH. --> 219645	2.0 Turbo Limousine	132	09.93-10.96	01.94 -->	<b>KV 234</b>
<b>KV 245</b>	CH. 219646 -->	2.0 Turbo Limousine	132	09.93-10.96	01.94 -->	<b>KV 234</b>
<b>KV 245</b>	01.94 --> / CH. --> 121428	2.0 Turbo Estate Car	132	09.93-10.97	01.94 -->	<b>KV 234</b>
<b>KV 245</b>	CH. 121429 -->	2.0 Turbo Estate Car	132	09.93-10.97	01.94 -->	<b>KV 234</b>
<b>KV 245</b>	01.94 --> / CH. --> 121428	2.0 20V TURBO Estate Car	155	02.93-12.96	01.94 -->	<b>KV 234</b>
<b>KV 245</b>	CH. 121429 -->	2.0 20V TURBO Estate Car	155	02.93-12.96	01.94 -->	<b>KV 234</b>
		2.0 20V TURBO Estate Car	155	02.93-12.96	01.94 -->	<b>KV 234</b>
<b>KV 245</b>	01.94 --> / CH. --> 219645	2.0 20V TURBO Limousine	155	08.93-12.96	01.94 -->	<b>KV 234</b>
<b>KV 245</b>	CH. 219646 -->	2.0 20V TURBO Limousine	155	08.93-12.96	01.94 -->	<b>KV 234</b>
<b>KV 245</b>	CH. --> 219645	2.3 Limousine	106	01.96-10.96		<b>KV 234</b>
<b>KV 245</b>	CH. 219646 -->	2.3 Limousine	106	01.96-10.96		<b>KV 234</b>
<b>KV 245</b>	CH. --> 121428	2.3 Estate Car	106	01.96-10.96		<b>KV 234</b>

	<b>i</b>	<b>ENGINE</b>	<b>POWER (kW)</b>	<b>YEAR</b>	<b>i</b>	
Fersa KIT FRONT						Fersa KIT REAR
<b>VOLVO</b>						
<b>850</b>						
<b>KV 245</b>	CH. 121429 -->	2.3 Estate Car	106	01.96-10.96		<b>KV 234</b>
<b>KV 245</b>	01.94 --> / CH. --> 121428	2.3 T5 Estate Car	166	02.93-12.96	01.94 -->	<b>KV 234</b>
<b>KV 245</b>	CH. 121429 -->	2.3 T5 Estate Car	166	02.93-12.96	01.94 -->	<b>KV 234</b>
<b>KV 245</b>	01.94 --> / CH. --> 219645	2.3 T5 Limousine	166	08.93-07.96	01.94 -->	<b>KV 234</b>
<b>KV 245</b>	CH. 219646 -->	2.3 T5 Limousine	166	08.93-07.96	01.94 -->	<b>KV 234</b>
<b>KV 245</b>	CH. --> 219645	2.3 T5 R Limousine	176	04.96-10.96		<b>KV 234</b>
<b>KV 245</b>	CH. 219646 -->	2.3 T5 R Limousine	176	04.96-10.96		<b>KV 234</b>
<b>KV 245</b>	CH. --> 121428	2.3 T5 R Estate Car	176	04.96-10.96		<b>KV 234</b>
<b>KV 245</b>	CH. 121429 -->	2.3 T5 R Estate Car	176	04.96-10.96		<b>KV 234</b>
<b>KV 245</b>	CH. --> 219645	2.3 Turbo R Limousine	177	06.95-10.96		<b>KV 234</b>
<b>KV 245</b>	CH. 219646 -->	2.3 Turbo R Limousine	177	06.95-10.96		<b>KV 234</b>
<b>KV 245</b>	CH. --> 121428	2.3 Turbo R Estate Car	177	06.95-10.97		<b>KV 234</b>
<b>KV 245</b>	CH. 121429 -->	2.3 Turbo R Estate Car	177	06.95-10.97		<b>KV 234</b>
<b>KV 245</b>	CH. --> 219645	2.3 T5-R Limousine	184	08.95-12.96		<b>KV 234</b>
<b>KV 245</b>	CH. 219646 -->	2.3 T5-R Limousine	184	08.95-12.96		<b>KV 234</b>
<b>KV 245</b>	CH. --> 121428	2.3 T5-R Estate Car	184	08.95-12.96		<b>KV 234</b>
<b>KV 245</b>	CH. 121429 -->	2.3 T5-R Estate Car	184	08.95-12.96		<b>KV 234</b>
<b>KV 245</b>	01.94 --> / CH. --> 219645	2.4 10V Limousine	103	06.91-07.94	01.94 -->	<b>KV 234</b>
<b>KV 245</b>	CH. 219646 -->	2.4 10V Limousine	103	06.91-07.94	01.94 -->	<b>KV 234</b>
<b>KV 245</b>	01.94 --> / CH. --> 121428	2.4 10V Estate Car	103	08.92-07.94	01.94 -->	<b>KV 234</b>
<b>KV 245</b>	CH. 121429 -->	2.4 10V Estate Car	103	08.92-07.94	01.94 -->	<b>KV 234</b>
<b>KV 245</b>	CH. --> 219645	2.4 10V Limousine	106	08.94-12.96		<b>KV 234</b>
<b>KV 245</b>	CH. 219646 -->	2.4 10V Limousine	106	08.94-12.96		<b>KV 234</b>
<b>KV 245</b>	CH. --> 121428	2.4 10V Estate Car	106	08.94-12.96		<b>KV 234</b>
<b>KV 245</b>	CH. 121429 -->	2.4 10V Estate Car	106	08.94-12.96		<b>KV 234</b>
<b>KV 245</b>	01.94 --> / CH. --> 219645	2.4 20V Limousine	125	08.91-12.96	01.94 -->	<b>KV 234</b>
<b>KV 245</b>	CH. 219646 -->	2.4 20V Limousine	125	08.91-12.96	01.94 -->	<b>KV 234</b>
<b>KV 245</b>	01.94 --> / CH. --> 121428	2.4 20V Estate Car	125	09.92-12.96	01.94 -->	<b>KV 234</b>
<b>KV 245</b>	CH. 121429 -->	2.4 20V Estate Car	125	09.92-12.96	01.94 -->	<b>KV 234</b>
<b>KV 245</b>	01.94 --> / CH. --> 219645	2.4 GLE Limousine	142	09.93-10.97	01.94 -->	<b>KV 234</b>
<b>KV 245</b>	CH. 219646 -->	2.4 GLE Limousine	142	09.93-10.97	01.94 -->	<b>KV 234</b>
<b>KV 245</b>	01.94 --> / CH. --> 121428	2.4 GLE Estate Car	142	09.93-10.97	01.94 -->	<b>KV 234</b>
<b>KV 245</b>	CH. 121429 -->	2.4 GLE Estate Car	142	09.93-10.97	01.94 -->	<b>KV 234</b>
<b>KV 245</b>	CH. --> 121428	2.4 AWD Estate Car	142	04.96-12.96		<b>KV 234</b>
<b>KV 245</b>	CH. 121429 -->	2.4 AWD Estate Car	142	04.96-12.96		<b>KV 234</b>
<b>KV 245</b>	CH. --> 219645	2.5 TDI Limousine	103	08.95-12.96		<b>KV 234</b>
<b>KV 245</b>	CH. 219646 -->	2.5 TDI Limousine	103	08.95-12.96		<b>KV 234</b>
<b>KV 245</b>	CH. --> 121428	2.5 TDI Estate Car	103	08.95-12.96		<b>KV 234</b>
<b>KV 245</b>	CH. 121429 -->	2.5 TDI Estate Car	103	08.95-12.96		<b>KV 234</b>
<b>940</b>						
		2.0 Limousine; 2.0 Estate Car	82	01.92-07.94		<b>KA 212</b>
		2.3 Limousine; 2.3 Estate Car; 2.3 16V Limousine; 2.3 16V Estate Car	85-114	08.90-12.94		<b>KA 212</b>
		2.4 D Limousine; 2.4 TD Limousine; 2.4 TD Estate Car; 2.4 TD Interc. Limousine	60-90	08.90-12.94		<b>KA 212</b>
<b>940 II</b>						
		2.3 Limousine; 2.3 Estate Car; 2.3 TURBO Limousine; 2.3 TURBO Estate Car	85-126	08.94-10.98		<b>KA 212</b>
		2.4 TD Interc. Limousine; 2.4 TD Interc. Estate Car	90	08.94-10.98		<b>KA 212</b>
<b>960</b>						
		2.9 Estate Car; 3.0 Limousine	150	08.90-07.94		<b>KA 212</b>

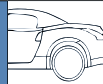

		ENGINE	POWER (kW)	YEAR		
Fersa KIT FRONT						Fersa KIT REAR
<b>VOLVO</b>						
<b>960</b>						
		2.4 TD Interc. Limousine	85	09.91-07.94		<b>KA 212</b>
		2.4 TD Interc. Estate Car	85	09.91-07.94		<b>KA 212</b>
<b>960 II</b>						
		2.5 24V Limousine; 2.5 24V Estate Car; 2.9 24V Limousine; 2.9 24V Estate Car	125-150	07.94-12.96		<b>KA 212</b>
<b>C70</b>						
<b>KV 249</b>		2.0 20V T Coupe; 2.0 20V T Convertible	120	03.00-10.05		<b>KV 234</b>
		2.0 20V T Coupe; 2.0 20V T Convertible	120	03.00-10.05		<b>KV 234</b>
<b>KV 245</b>	--> 12.98	2.0 20V Coupe; 2.0 20V Convertible; 2.0 20V TURBO Coupe; 2.0 20V TURBO Convertible; 2.3 20V T-5 Coupe; 2.3 20V T-5 Convertible	132-176	03.97-10.05		<b>KV 234</b>
<b>KV 249</b>	01.99 -->	2.0 20V Coupe; 2.0 20V Convertible; 2.0 20V TURBO Coupe; 2.0 20V TURBO Convertible; 2.3 20V T-5 Coupe; 2.3 20V T-5 Convertible	132-176	03.97-10.05		<b>KV 234</b>
		2.0 20V Coupe; 2.0 20V Convertible; 2.0 20V TURBO Coupe; 2.0 20V TURBO Convertible; 2.3 20V T-5 Coupe; 2.3 20V T-5 Convertible	132-176	03.97-10.05		<b>KV 234</b>
<b>KV 249</b>		2.3 T5 Convertible; 2.4 20V Coupe; 2.5 20 V Coupe	121-180	03.99-10.05		<b>KV 234</b>
		2.3 T5 Convertible; 2.4 20V Coupe; 2.5 20 V Coupe	121-180	03.99-10.05		<b>KV 234</b>
<b>KV 245</b>	--> 12.98	2.4 20V Convertible; 2.4 20V TURBO Convertible; 2.5 20V TURBO Coupe	125-142	03.97-10.05		<b>KV 234</b>
<b>KV 249</b>	01.99 -->	2.4 20V Convertible; 2.4 20V TURBO Convertible; 2.5 20V TURBO Coupe	125-142	03.97-10.05		<b>KV 234</b>
		2.4 20V Convertible; 2.4 20V TURBO Convertible; 2.5 20V TURBO Coupe	125-142	03.97-10.05		<b>KV 234</b>
<b>KV 249</b>		2.4 T Convertible	147	07.02-10.05		<b>KV 234</b>
<b>S40 I</b>						
<b>KF 302</b>		1.6 16V	80	03.99-12.03		<b>KV 242</b>
<b>KF 302</b>	10.97 -->	1.6 16V; 1.8 16V	77-85	07.95-08.99		
		1.6 16V; 1.8 16V	77-85	07.95-08.99		<b>KV 242</b>
<b>KF 302</b>		1.8 16V; 1.8i	90-92	03.98-12.03		<b>KV 242</b>
<b>KF 302</b>	10.97 -->	1.9 T4; 2.0 16V	100-147	07.95-12.03		<b>KV 242</b>
<b>KF 302</b>		2.0 T; 2.0 T4	118-147	10.97-12.03		<b>KV 242</b>
<b>KF 302</b>	10.97 -->	1.9 TD	66	07.95-08.99		<b>KV 242</b>
<b>KF 302</b>		1.9 DI	70-85	03.99-12.03		<b>KV 242</b>
<b>S60</b>						
		2.4; 2.4 T; T5	103-184	11.00-		<b>KV 177</b>
		2.4 D 5	120	07.01-		<b>KV 177</b>
<b>S70</b>						
<b>KV 245</b>	--> 12.98	2.0; 2.0 20V; 2.0 20V TURBO; 2.3 20V T-5; 2.3 TURBO	93-184	01.97-11.00		<b>KV 177</b>
<b>KV 249</b>	01.99 -->	2.0; 2.0 20V; 2.0 20V TURBO; 2.3 20V T-5; 2.3 TURBO	93-184	01.97-11.00		<b>KV 177</b>
		2.0; 2.0 20V; 2.0 20V TURBO; 2.3 20V T-5; 2.3 TURBO	93-184	01.97-11.00		<b>KV 234</b>
<b>KV 245</b>		2.3 T5 GLT AWD; 2.3 T5 R AWD; 2.3 T5 Sport	176-177	11.96-09.98		<b>KV 234</b>
<b>KV 245</b>	--> 12.98	2.3 T5 Sport AWD	184	07.97-09.00		<b>KV 234</b>
<b>KV 249</b>	01.99 -->	2.3 T5 Sport AWD	184	07.97-09.00		<b>KV 234</b>
<b>KV 249</b>		2.3 AWD; 2.4 16V; 2.5 Bifuel	103-195	04.99-11.00		<b>KV 234</b>
<b>KV 245</b>	--> 12.98	2.4; 2.4 20 V; 2.4 20V; 2.4 20V TURBO; 2.4 Bifuel; 2.4 T5 Sport AWD	106-142	11.96-11.00		<b>KV 234</b>
<b>KV 249</b>	01.99 -->	2.4; 2.4 20 V; 2.4 20V; 2.4 20V TURBO; 2.4 Bifuel; 2.4 T5 Sport AWD	106-142	11.96-11.00		<b>KV 234</b>
<b>KV 245</b>	--> 12.98	2.5 TDI	103	01.97-11.00		<b>KV 234</b>
<b>KV 249</b>	01.99 -->	2.5 TDI	103	01.97-11.00		<b>KV 234</b>
		2.5 TDI	103	01.97-11.00		<b>KV 234</b>

	<b>i</b>	ENGINE	POWER (kW)	YEAR	<b>i</b>	
Fersa KIT FRONT						Fersa KIT REAR
<b>VOLVO</b>						
<b>S80</b>						
		2.0 20V; 2.0 T; 2.4 20 V; 2.4 20V; 2.4 Bifuel; 2.4 T; 2.8 24V TURBO; 2.9 24V; 3.0; 3.0 T6	103-200	05.98-07.06		<b>KV 177</b>
		2.4 D; 2.4 D 5; 2.5 TDI	96-120	01.99-07.06		<b>KV 177</b>
<b>V40</b>						
<b>KF 302</b>		1.6 16V	80	03.99-06.04		<b>KV 242</b>
<b>KF 302</b>	10.97 -->	1.6 16V; 1.8 16V	77-85	07.95-08.99		<b>KV 242</b>
<b>KF 302</b>		1.8 16V; 1.8i	90-92	03.98-06.04		<b>KV 242</b>
<b>KF 302</b>	10.97 -->	1.9 T4; 2.0 16V	100-147	07.95-06.04		<b>KV 242</b>
<b>KF 302</b>		1.9 T 16V; 2.0 T; 2.0 T4	118-147	10.97-06.04		<b>KV 242</b>
<b>KF 302</b>	10.97 -->	1.9 TD	66	07.95-08.99		<b>KV 242</b>
<b>KF 302</b>		1.9 DI	70-85	03.99-06.04		<b>KV 242</b>
<b>V70 I</b>						
<b>KV 245</b>	--> 12.98	2.0; 2.0 20V; 2.0 20V TURBO	93-166	01.97-03.00		<b>KV 234</b>
<b>KV 249</b>	01.99 -->	2.0; 2.0 20V; 2.0 20V TURBO	93-166	01.97-03.00		<b>KV 234</b>
<b>KV 245</b>	--> 12.98	2.0 TURBO 20V AWD	166	01.97-03.00		<b>KV 234</b>
<b>KV 249</b>	01.99 -->	2.0 TURBO 20V AWD	166	01.97-03.00		<b>KV 234</b>
<b>KV 245</b>	--> 12.98	2.3 20V T-5; 2.3 TURBO	176-184	01.97-03.00		<b>KV 234</b>
<b>KV 249</b>	01.99 -->	2.3 20V T-5; 2.3 TURBO	176-184	01.97-03.00		<b>KV 234</b>
<b>KV 245</b>	--> 12.98	2.3 AWD; 2.3 20V T-5 AWD; 2.3 T AWD	176-195	01.97-03.00		<b>KV 234</b>
<b>KV 249</b>	01.99 -->	2.3 AWD; 2.3 20V T-5 AWD; 2.3 T AWD	176-195	01.97-03.00		<b>KV 234</b>
<b>KV 249</b>		2.4 16V; 2.4 16V Bifuel	103	08.99-05.00		<b>KV 234</b>
<b>KV 245</b>	--> 12.98	2.4	106	01.97-03.00		<b>KV 234</b>
<b>KV 249</b>	01.99 -->	2.4	106	01.97-03.00		<b>KV 234</b>
<b>KV 249</b>		2.5 Bifuel	106	10.98-08.99		<b>KV 234</b>
<b>KV 245</b>	--> 12.98	2.4 20V; 2.4 20V TURBO; 2.5 20V	121-142	01.97-05.00		<b>KV 234</b>
<b>KV 249</b>	01.99 -->	2.4 20V; 2.4 20V TURBO; 2.5 20V	121-142	01.97-05.00		<b>KV 234</b>
<b>KV 245</b>	--> 12.98	2.5 20V TURBO AWD	142	01.97-05.00		<b>KV 234</b>
<b>KV 249</b>	01.99 -->	2.5 20V TURBO AWD	142	01.97-05.00		<b>KV 234</b>
<b>KV 249</b>		2.4 AWD; 2.5 AWD	195	03.99-03.00		<b>KV 234</b>
<b>KV 245</b>	--> 12.98	2.5 TDI	103	01.97-05.00		<b>KV 234</b>
<b>KV 249</b>	01.99 -->	2.5 TDI	103	01.97-05.00		<b>KV 234</b>
<b>V70 II</b>						
		2.0 T	132	07.01-		<b>KV 177</b>
<b>KV 249</b>	--> 12.00	2.3 T5; 2.4	103-184	03.00-	--> 12.00	<b>KV 234</b>
		2.3 T5; 2.4	103-184	03.00-	01.01 -->	<b>KV 177</b>
		2.4 Bifuel	103	09.01-		<b>KV 177</b>
<b>KV 249</b>	--> 12.00	2.4; 2.4 T	125-147	03.00-	--> 12.00	<b>KV 234</b>
		2.4; 2.4 T	125-147	03.00-	01.01 -->	<b>KV 177</b>
		2.4 D	96-120	08.01-		<b>KV 177</b>
<b>KV 249</b>	--> 12.00	2.5 TDI	103	03.00-	--> 12.00	<b>KV 234</b>
		2.5 TDI	103	03.00-	01.01 -->	<b>KV 177</b>
<b>ZASTAVA</b>						
<b>YUGO FLORIDA</b>						
<b>KF 160</b>		1.1; 1.3 (103 A); 1.4; 1.6	44-62	10.88-		<b>KV 162</b>
<b>ZASTAVA 101 (1100)</b>						
<b>KF 161</b>		1.1	37	12.75-01.80		<b>KV 162</b>
<b>KF 161</b>	--> 06.82	1.1	40-41	06.73-12.93		
<b>KF 160</b>	07.82 -->	1.1	40-41	06.73-12.93		

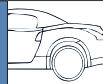
	<b>i</b>	ENGINE	POWER (kW)	YEAR	<b>i</b>	
Fersa KIT FRONT						Fersa KIT REAR
<b>ZASTAVA</b>						
<b>ZASTAVA 101 (1100)</b>						
		1.1	40-41	06.73-12.93		<b>KV 162</b>
<b>KF 161</b>		1.1 SUPER	47	07.79-09.81		<b>KV 162</b>
<b>KF 161</b>	--> 06.82	1.3	48	10.81-12.93		
<b>KF 160</b>	07.82 -->	1.3	48	10.81-12.93		
		1.3	48	10.81-12.93		<b>KV 162</b>
<b>ZASTAVA YUGO</b>						
<b>KF 161</b>		1.1 60 EFI (145 A); 1.3 60 EFI (145 A)	44-48	08.91-06.95		<b>KV 162</b>



## 08/ Pictures of Fersa wheel bearing kits

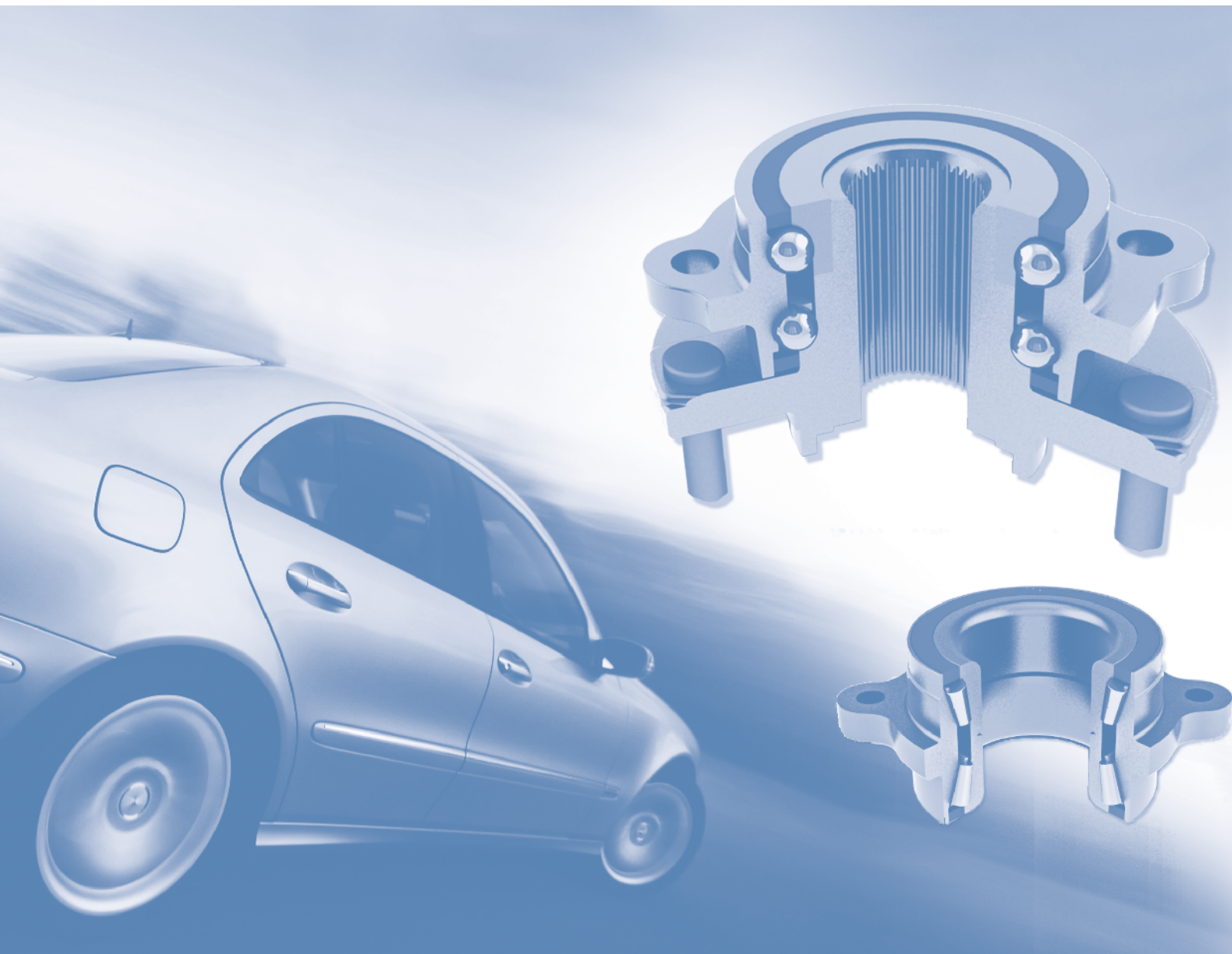











































## 08 Pictures of Fersa wheel bearing kits























Product range





















<p>KA 001</p> 	<p>KA 002</p> 	<p>KA 003</p> 	<p>KA 004</p> 
<p>KA 005</p> 	<p>KA 006</p> 	<p>KA 007</p> 	<p>KB 008</p> 
<p>KA 009</p> 	<p>KA 010</p> 	<p>KB 011</p> 	<p>KB 012</p> 
<p>KA 013</p> 	<p>KA 014</p> 	<p>KA 015</p> 	<p>KA 016</p> 
<p>KA 017</p> 	<p>KA 018</p> 	<p>KA 019</p> 	<p>KA 020</p> 



















<p>KA 021</p> 	<p>KA 022</p> 	<p>KA 023</p> 	<p>KA 024</p> 
<p>KA 025</p> 	<p>KA 026</p> 	<p>KA 027</p> 	<p>KA 028</p> 
<p>KA 029</p> 	<p>KA 030</p> 	<p>KA 031</p> 	<p>KA 032</p> 
<p>KA 033</p> 	<p>KA 034</p> 	<p>KA 035</p> 	<p>KA 036</p> 
<p>KA 037</p> 	<p>KA 038</p> 	<p>KA 039</p> 	<p>KA 040</p> 



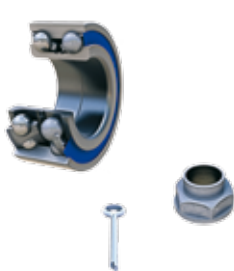
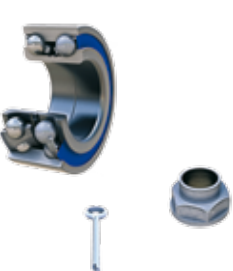
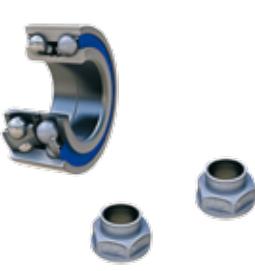

















Product range

<p>KA 041</p> 	<p>KA 042</p> 	<p>KA 043</p> 	<p>KA 044</p> 
<p>KB 045</p> 	<p>KB 046</p> 	<p>KB 047</p> 	<p>KB 048</p> 
<p>KA 049</p> 	<p>KA 050</p> 	<p>KA 051</p> 	<p>KA 052</p> 
<p>KA 053</p> 	<p>KA 054</p> 	<p>KA 055</p> 	<p>KA 056</p> 
<p>KA 057</p> 	<p>KA 058</p> 	<p>KA 059</p> 	<p>KA 060</p> 

<p>KA 061</p> 	<p>KB 062</p> 	<p>KA 063</p> 	<p>KA 064</p> 
<p>KA 065</p> 	<p>KA 066</p> 	<p>KA 067</p> 	<p>KA 068</p> 
<p>KA 069</p> 	<p>KA 070</p> 	<p>KA 071</p> 	<p>KA 072</p> 
<p>KA 073</p> 	<p>KA 074</p> 	<p>KA 075</p> 	<p>KA 076</p> 
<p>KA 077</p> 	<p>KB 078</p> 	<p>KA 079</p> 	<p>KA 080</p> 

Product range











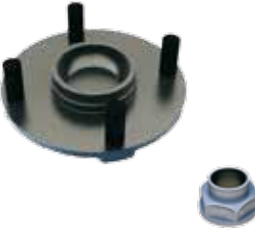

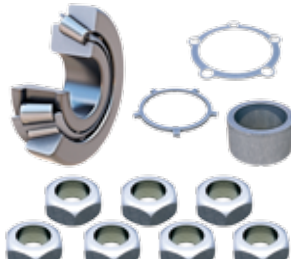
<p>KA 081</p> 	<p>KA 082</p> 	<p>KA 083</p> 	<p>KA 084</p> 
<p>KA 085</p> 	<p>KA 086</p> 	<p>KA 087</p> 	<p>KA 088</p> 
<p>KA 089</p> 	<p>KB 090</p> 	<p>KA 091</p> 	<p>KF 092</p> 
<p>KF 093</p> 	<p>KF 094</p> 	<p>KF 095</p> 	<p>KF 096</p> 
<p>KV 097</p> 	<p>KF 098</p> 	<p>KF 099</p> 	<p>KV 100</p> 

<p><b>KF 101</b></p> 	<p><b>KF 102</b></p> 	<p><b>KV 103</b></p> 	<p><b>KF 104</b></p> 
<p><b>KV 105</b></p> 	<p><b>KF 106</b></p> 	<p><b>KF 107</b></p> 	<p><b>KV 108</b></p> 
<p><b>KF 109</b></p> 	<p><b>KF 010</b></p> 	<p><b>KF 111</b></p> 	<p><b>KF 112</b></p> 
<p><b>KF 113</b></p> 	<p><b>KV 114</b></p> 	<p><b>KF 115</b></p> 	<p><b>KF 116</b></p> 
<p><b>KD 117</b></p> 	<p><b>KD 118</b></p> 	<p><b>KF 119</b></p> 	<p><b>KV 120</b></p> 

Pictures



Product range











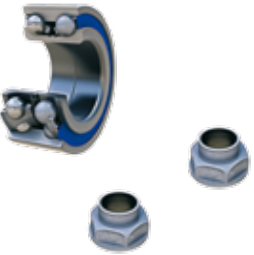
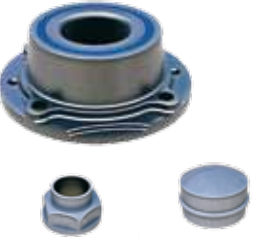
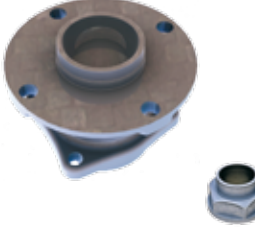







<p><b>KF 121</b></p> 	<p><b>KV 122</b></p> 	<p><b>KV 123</b></p> 	<p><b>KF 124</b></p> 
<p><b>KB 125</b></p> 	<p><b>KA 126</b></p> 	<p><b>KF 127</b></p> 	<p><b>KF 128</b></p> 
<p><b>KF 129</b></p> 	<p><b>KF 130</b></p> 	<p><b>KA 131</b></p> 	<p><b>KC 132</b></p> 
<p><b>KF 133</b></p> 	<p><b>KF 134</b></p> 	<p><b>KV 135</b></p> 	<p><b>KF 136</b></p> 
<p><b>KF 137</b></p> 	<p><b>KF 138</b></p> 	<p><b>KF 139</b></p> 	<p><b>KF 140</b></p> 

KF 141	KF 142	KF 143	KV 144
			
KF 145	KC 146	KC 147	KC 148
			
KC 149	KF 150	KA 151	KV 152
			
KF 153	KV 154	KF 155	KV 156
			
KV 157	KF 158	KF 159	KF 160
			

Pictures



















Product range

<p><b>KF 161</b></p> 	<p><b>KV 162</b></p> 	<p><b>KV 163</b></p> 	<p><b>KV 164</b></p> 
<p><b>KF 165</b></p> 	<p><b>KF 166</b></p> 	<p><b>KF 167</b></p> 	<p><b>KF 168</b></p> 
<p><b>KA 169</b></p> 	<p><b>KA 170</b></p> 	<p><b>KA 171</b></p> 	<p><b>KF 172</b></p> 
<p><b>KF 173</b></p> 	<p><b>KC 174</b></p> 	<p><b>KF 175</b></p> 	<p><b>KF 176</b></p> 
<p><b>KV 177</b></p> 	<p><b>KV 178</b></p> 	<p><b>KF 179</b></p> 	<p><b>KF 180</b></p> 

KF 181	KF 182	KF 183	KF 184
KF 185	KA 186	KA 187	KC 188
KA 189	KA 190	KB 191	KB 192
KB 193	KV 194	KF 195	KV 196
KF 197	KV 198	KV 199	KA 200

Pictures





















Product range



















<p><b>KF 201</b></p> 	<p><b>KV 202</b></p> 	<p><b>KF 203</b></p> 	<p><b>KV 204</b></p> 
<p><b>KC 205</b></p> 	<p><b>KA 206</b></p> 	<p><b>KA 207</b></p> 	<p><b>KA 208</b></p> 
<p><b>KC 209</b></p> 	<p><b>KA 210</b></p> 	<p><b>KA 211</b></p> 	<p><b>KA 212</b></p> 
<p><b>KA 213</b></p> 	<p><b>KA 214</b></p> 	<p><b>KV 215</b></p> 	<p><b>KF 216</b></p> 
<p><b>KB 217</b></p> 	<p><b>KV 218</b></p> 	<p><b>KV 219</b></p> 	<p><b>KV 220</b></p> 

KV 221	KV 222	KC 223	KC 224
			
KF 225	KV 226	KF 227	KV 228
			
KV 229	KV 230	KV 231	KV 232
			
KF 233	KV 234	KV 235	KV 236
			
KV 237	KV 238	KV 239	KF 240
			



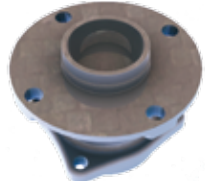

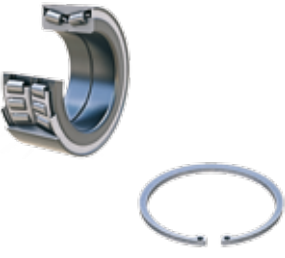







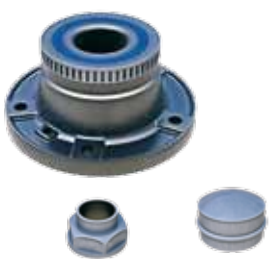



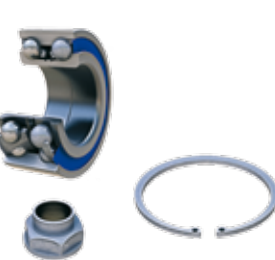



Product range



<p><b>KF 241</b></p> 	<p><b>KV 242</b></p> 	<p><b>KV 243</b></p> 	<p><b>KV 244</b></p> 
<p><b>KV 245</b></p> 	<p><b>KV 246</b></p> 	<p><b>KV 247</b></p> 	<p><b>KA 248</b></p> 
<p><b>KV 249</b></p> 	<p><b>KV 250</b></p> 	<p><b>KV 251</b></p> 	<p><b>KV 252</b></p> 
<p><b>KC 253</b></p> 	<p><b>KA 254</b></p> 	<p><b>KA 255</b></p> 	<p><b>KC 256</b></p> 
<p><b>KA 257</b></p> 	<p><b>KV 258</b></p> 	<p><b>KF 259</b></p> 	<p><b>KV 260</b></p> 

KF 261	KB 262	KB 263	KF 264
			
KC 265	KA 266	KV 267	KA 268
			
KA 269	KF 270	KV 271	KA 272
			
KA 273	KF 274	KV 275	KV 276
			
KF 277	KB 278	KV 279	KF 280
			

Product range

<p><b>KF 281</b></p> 	<p><b>KF 282</b></p> 	<p><b>KF 283</b></p> 	<p><b>KV 284</b></p> 
<p><b>KV 285</b></p> 	<p><b>KV 286</b></p> 	<p><b>KV 287</b></p> 	<p><b>KF 288</b></p> 
<p><b>KF 289</b></p> 	<p><b>KV 290</b></p> 	<p><b>KV 291</b></p> 	<p><b>KF 292</b></p> 
<p><b>KB 293</b></p> 	<p><b>KV 294</b></p> 	<p><b>KB 295</b></p> 	<p><b>KB 296</b></p> 
<p><b>KA 297</b></p> 	<p><b>KF 298</b></p> 	<p><b>KF 299</b></p> 	<p><b>KF 300</b></p> 



<p><b>KF 301</b></p> 	<p><b>KF 302</b></p> 	<p><b>KF 303</b></p> 	<p><b>KF 304</b></p> 
<p><b>KV 305</b></p> 	<p><b>KF 306</b></p> 	<p><b>KF 307</b></p> 	<p><b>KF 308</b></p> 
<p><b>KF 309</b></p> 	<p><b>KF 310</b></p> 	<p><b>KF 311</b></p> 	<p><b>KF 312</b></p> 
<p><b>KF 313</b></p> 	<p><b>KF 314</b></p> 	<p><b>KF 315</b></p> 	<p><b>KF 316</b></p> 
<p><b>KF 317</b></p> 	<p><b>KB 318</b></p> 	<p><b>KF 319</b></p> 	<p><b>KF 320</b></p> 

Pictures

Product range

<p><b>KF 321</b></p> 	<p><b>KV 322</b></p> 	<p><b>KV 323</b></p> 	<p><b>KV 324</b></p> 
<p><b>KV 325</b></p> 	<p><b>KV 326</b></p> 	<p><b>KF 327</b></p> 	<p><b>KV 328</b></p> 
<p><b>KF 329</b></p> 	<p><b>KV 330</b></p> 	<p><b>KV 331</b></p> 	<p><b>KV 332</b></p> 
<p><b>KV 333</b></p> 	<p><b>KF 334</b></p> 	<p><b>KV 335</b></p> 	<p><b>KV 336</b></p> 
<p><b>KV 337</b></p> 	<p><b>KB 338</b></p> 	<p><b>KB 339</b></p> 	<p><b>KF 340</b></p> 

<p>KF 341</p> 	<p>KF 342</p> 	<p>KV 343</p> 	<p>KB 344</p> 
<p>KB 345</p> 	<p>KF 346</p> 	<p>KA 347</p> 	<p>KF 348</p> 
<p>KA 349</p> 	<p>KB 350</p> 	<p>KF 351</p> 	<p>KF 352</p> 
<p>KV 353</p> 	<p>KF 354</p> 		

Pictures

## 09/ Content of the kits (Bill of material)

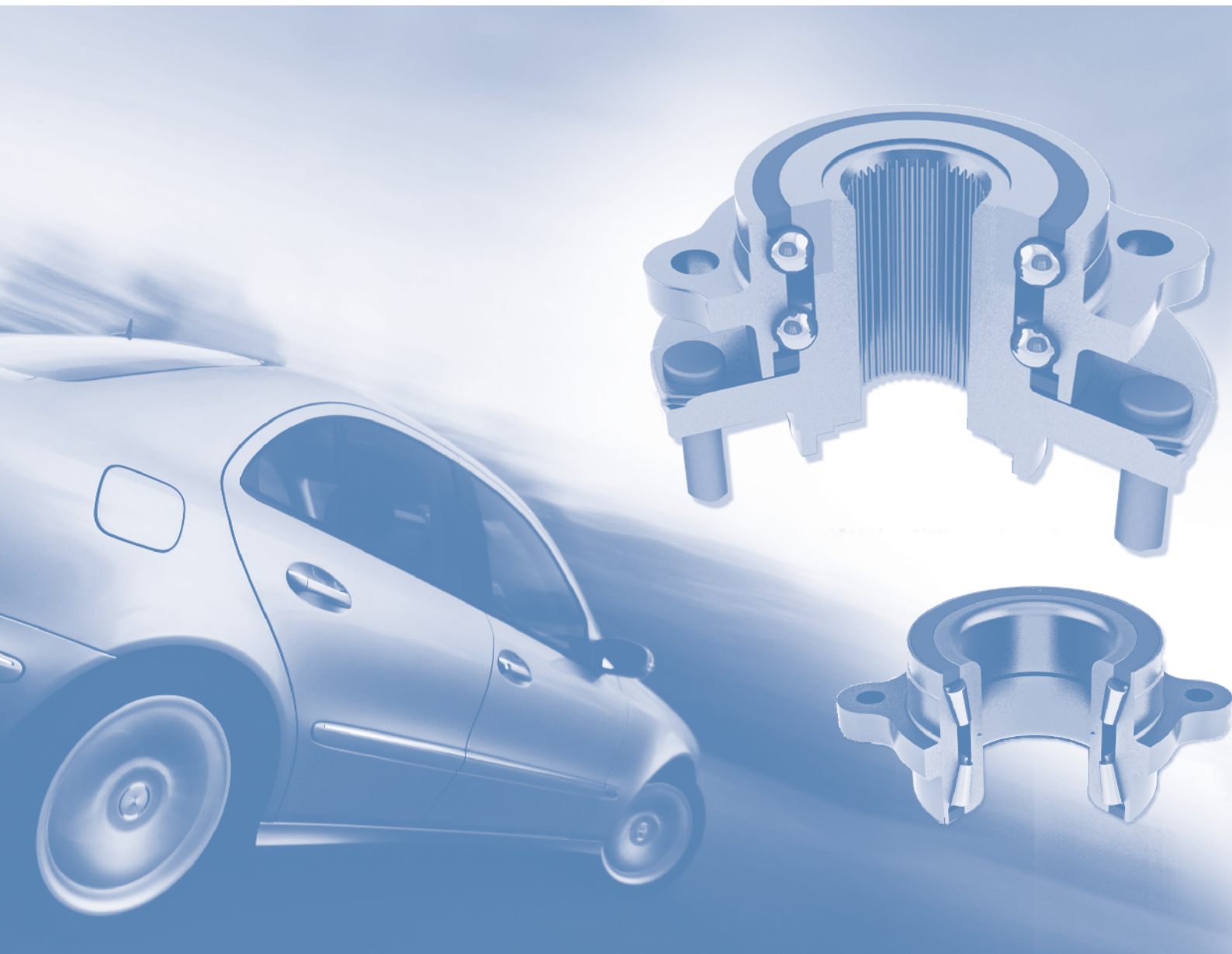























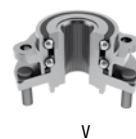









## 09 Content of the kits (Bill of material)

09. Content of the Kits (Bill of material)

															
Fersa KIT	FRONT WHEEL	REAR WHEEL	BEARINGS	TYPE	Locking Washer	Nut	Screw	Spacer	Locking	Circlip	Oil Seal	O-Ring Gasket	Shield Plate	Split Pin	Grease Cap
KA 001	X	X	2	A		1					1				
KA 002	X		2	A							1			1	
KA 003	X		2	A		1					1			1	
KA 004	X		2	A							1			1	
KA 005		X	2	A							1			2	
KA 006	X	X	2	A	1						1			1	1
KA 007	X	X	2	A							1			1	
KB 008		X	1	B		1				1	3				
KA 009	X		2	A		1					2				
KA 010		X	2	A		1					1				
KB 011	X		1	B		1					2				
KB 012		X	1	B		1					1				
KA 013		X	2	A		1					1				
KA 014	X	X	2	A							1			1	
KA 015	X		2	A		1					2				
KA 016	X	X	2	A							1			1	
KA 017	X		2	A							1			1	
KA 018	X		2	A		1					1				
KA 019	X		2	A		1					2				
KA 020	X	X	2	A		1									
KA 021		X	2	A							1				
KA 022	X		2	A							2			1	
KA 023	X		2	A							1			1	
KA 024	X		2	A		1					2				
KA 025	X		2	A							1				
KA 026		X	2	A	1	1		1			3				
KA 027	X		2	A							1				
KA 028	X		2	A							1				
KA 029	X	X	2	A							1				
KA 030	X		2	A							1				
KA 031	X		2	A							2				
KA 032		X	2	A	1						1				
KA 033	X		2	A		1		1			2				
KA 034		X	2	A							1			1	
KA 035	X		2	A							1				
KA 036	X		2	A							1			1	
KA 037		X	2	A							1				
KA 038	X	X	2	A							1			1	
KA 039	X	X	2	A							1			1	
KA 040	X		2	A							1			1	
KA 041	X		2	A	1	1					1	1			
KA 042	X	X	2	A							1			1	
KA 043		X	2	A							1			1	
KA 044		X	2	A							1			1	
KB 045		X	1	B		1				1					
KB 046		X	1	B		1				1					
KB 047		X	1	B		1				1					
KB 048	X		1	B		1				1					
KA 049		X	2	A		1					1				
KA 050	X	X	2	A	1					1	2	3			
KA 051	X	X	2	A	1						2	2		2	
KA 052	X	X	2	A	2					1	1	1			



															
Fersa KIT	FRONT WHEEL	REAR WHEEL	BEARINGS	TYPE	Locking Washer	Nut	Screw	Spacer	Locking	Circlip	Oil Seal	O-Ring Gasket	Shield Plate	Split Pin	Grease Cap
KA 053	X	X	2	A	1						2	1			
KA 054		X	2	A							1			1	
KA 055	X		2	A		2					1				
KA 056	X		2	A											
KA 057	X		2	A											
KA 058		X	2	A		2					1				
KA 059	X		2	A	1					1	2				
KA 060		X	2	A						1	1				
KA 061	X		2	A	1						2				
KB 062	X	X	1	B						1	2				
KA 063	X	X	2	A		1					1			1	
KA 064	X		2	A							1			1	
KA 065	X		2	A							1			1	
KA 066	X		2	A		1					1				
KA 067	X		2	A											
KA 068	X		2	A							1			1	
KA 069	X	X	2	A	1						1			1	1
KA 070	X		2	A							1			1	
KA 071	X		2	A		1					2	1			
KA 072		X	2	A		1					2				
KA 073		X	2	A		1					2	1			
KA 074	X		2	A		1					1				
KA 075	X	X	2	A							1			1	
KA 076		X	2	A		1				1	2				
KA 077		X	2	A		1					2				
KB 078		X	1	B		1					1				
KA 079	X	X	2	A		1					1				
KA 080		X	2	A		1					1				
KA 081	X		2	A							1			1	
KA 082		X	2	A	1						2				
KA 083	X	X	2	A							1			1	
KA 084		X	2	A	1						1			1	
KA 085	X		2	A							1			1	
KA 086	X	X	2	A							1			1	
KA 087	X		2	A	1						2				
KA 088		X	2	A		1					1				
KA 089		X	2	A		1					1				
KB 090		X	1	B		1				1					
KA 091	X	X	2	A		1					1				
KF 092	X	X	1	F		1								1	
KF 093		X	1	F		1								1	
KF 094	X		1	F		2									
KF 095	X	X	1	F		4				2					
KF 096	X	X	1	F			1			2					
KV 097		X	1	V		1									1
KF 098	X	X	1	F			1			2					
KF 099	X	X	1	F		1				1					
KV 100		X	1	V		1									
KF 101	X	X	1	F		1				1					
KF 102	X		1	F		1				1					
KV 103	X		1	V		1									
KF 104		X	1	F	1					1					



A



B



C



D

















F



V



09. Content of the kits (Bill of material)

															
Fersa KIT	FRONT WHEEL	REAR WHEEL	BEARINGS	TYPE	Locking Washer	Nut	Screw	Spacer	Locking	Circlip	Oil Seal	O-Ring Gasket	Shield Plate	Split Pin	Grease Cap
KV 105	X		1	V		1									
KF 106		X	1	F	1					1					
KF 107		X	1	F	2					1					
KV 108	X		1	V		1									1
KF 109		X	1	F		1				1					
KF 110		X	1	F		1				1					
KF 111	X	X	1	F		1				1					
KF 112		X	1	F		1				1	1				
KF 113	X		1	F						1				1	
KV 114		X	1	V		1									
KF 115	X		1	F		1				1					
KF 116	X		1	F		1				2					
KD 117		X	1	D	1						1	2			
KD 118		X	1	D		1					1	2			
KF 119	X		1	F						1	2			1	
KV 120		X	1	V		1									
KF 121	X		1	F						1	2			1	
KV 122		X	1	V		1									
KV 123		X	1	V		1									
KF 124		X	1	F		1				1					
KB 125		X	1	B		1				1					
KA 126		X	1	A	1	7		1				1			
KF 127	X	X	1	F		1				1					
KF 128	X	X	1	F						2	2			2	
KF 129	X		1	F						1	1			1	
KF 130	X	X	1	F						2	3			1	
KA 131		X	2	A	1						2				
KC 132		X	1	C					1		1	1			
KF 133	X		1	F						2				1	
KF 134	X		1	F						2				1	
KV 135	X		1	V		1									
KF 136	X	X	1	F	1					1					
KF 137	X		1	F						2				1	
KF 138	X	X	1	F						2				1	
KF 139	X		1	F		1					2				
KF 140		X	1	F		1					2				
KF 141		X	1	F		1					2				
KF 142	X		1	F		1				1					
KF 143	X	X	1	F		1				1				1	
KV 144		X	1	V		1									
KF 145	X		1	F		1				1					
KC 146	X		1	C		1									
KC 147	X		1	C		1									
KC 148	X		2	C		1									
KC 149	X		1	C		1									
KF 150	X		1	F		1					2				
KF 151	X		1	F		1				1					
KV 152	X		1	V		1									
KF 153	X		1	F		1				1					
KV 154		X	1	V		1									
KF 155	X		1	F											
KV 156		X	1	V		1									



A



B



C















D



F



V

															
Fersa KIT	FRONT WHEEL	REAR WHEEL	BEARINGS	TYPE	Locking Washer	Nut	Screw	Spacer	Locking	Circlip	Oil Seal	O-Ring Gasket	Shield Plate	Split Pin	Grease Cap
KV 157		X	1	V		1									
KF 158	X	X	1	F		1				1		1			
KF 159	X	X	1	F		1				1					
KF 160	X		1	F		1				1	2		1		
KF 161	X	X	1	F		2									
KV 162		X	1	V		1									1
KV 163	X		1	V		1									
KV 164		X	1	V		1									1
KF 165	X		1	F		1				1					
KF 166	X	X	1	F		1				1					
KF 167	X	X	1	F		1				1					
KF 168	X		1	F		1				1					
KA 169	X		2	A		1					1	1			
KA 170		X	2	A							1				
KA 171	X		2	A											
KF 172	X		1	F		1					1				
KF 173		X	1	F		1					1	1			
KC 174		X	1	C							1	1			
KF 175	X		1	F		1				2					
KF 176	X		1	F		1				2					
KV 177		X	1	V		1									
KV 178		X	1	V		1									
KF 179	X		1	F		3				2					
KF 180	X		1	F		4				2					
KF 181	X		1	F		1				2					
KF 182	X	X	1	F		5	1			2					
KF 183	X		1	F		1				2					
KF 184	X	X	1	F		4				1					
KF 185	X	X	1	F		4				2					
KA 186		X	1	A	1						2	1			
KA 187		X	2	A		1					1				
KC 188		X	1	C					1		1	1			
KA 189	X		2	A			1				1				1
KA 190	X		2	A						1	1				
KB 191		X	1	B		1				1					
KB 192	X		1	B		1				1					
KB 193		X	1	B		1				1					
KV 194		X	1	V		1									1
KF 195	X		1	F		1				1					
KV 196	X		1	V		1	3							1	1
KF 197	X		1	F						1	2		1	1	
KV 198	X		1	V		1	3							1	1
KV 199	X		1	V		1	3							1	1
KA 200		X	2	A		2					1				
KF 201	X		1	F		1				1					
KV 202		X	1	V		4									
KF 203	X	X	1	F		2				1	2		1		
KV 204	X	X	1	V											
KC 205		X	1	C					1		1	2			
KA 206	X		2	A							1				
KA 207	X		2	A							1				
KA 208		X	2	A							1				



A



B



C



D















F



V

09. Content of the kits (Bill of material)

															
Fersa KIT	FRONT WHEEL	REAR WHEEL	BEARINGS	TYPE	Locking Washer	Nut	Screw	Spacer	Locking	Circlip	Oil Seal	O-Ring Gasket	Shield Plate	Split Pin	Grease Cap
KC 209		X	2	C							1				
KA 210		X	2	A		1		1			2			1	
KA 211		X	1	A					1		2				
KA 212		X	1	A					1		2				
KA 213	X		2	A		2					1				
KA 214	X		2	A		1					2				
KV 215		X	1	V		1									
KF 216	X		1	F		1	1			2					
KB 217		X	1	B						1	1			1	
KV 218		X	1	V		1									
KV 219		X	1	V		1									
KV 220		X	1	V		1									
KV 221		X	1	V		1									
KV 222		X	1	V											
KC 223	X		2	C							1			1	
KC 224		X	2	C										1	
KF 225	X	X	1	F		1				1	1				
KV 226		X	1	V		1									
KF 227	X	X	1	F		1				1	1				
KV 228		X	1	V		1									
KV 229	X		1	V											
KV 230		X	1	V		1									
KV 231		X	1	V		1									
KV 232		X	1	V		1									
KF 233	X	X	1	F		1	1			1					
KV 234		X	1	V		1									
KV 235		X	1	V		4									
KV 236		X	1	V		1									
KV 237		X	1	V		1									
KV 238	X		1	V			4								
KV 239		X	1	V		1	4								
KF 240	X	X	1	F			1			1					
KF 241		X	1	F		1	1			1					
KV 242		X	1	V		1	2								
KV 243		X	1	V		1									
KV 244		X	1	V		1									
KV 245	X		1	V		1									
KV 246		X	1	V		1									
KV 247	X		1	V		1	3							1	1
KA 248		X	2	A							1			1	
KV 249	X		1	V			5								
KV 250	X	X	1	V			5								
KV 251		X	1	V		1									1
KV 252		X	1	V		4									
KC 253		X	1	C					1		1	1			
KA 254	X		2	A							2				
KA 255	X		2	A		1					2				
KC 256		X	2	C						1	2			1	
KA 257		X	2	A		1					2				
KV 258		X	1	V		1									
KF 259	X	X	1	F						1	2		1	2	
KV 260		X	1	V		1									

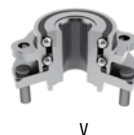

Fersa KIT	FRONT WHEEL	REAR WHEEL	BEARINGS	TYPE	Locking Washer	Nut	Screw	Spacer	Locking	Circlip	Oil Seal	O-Ring Gasket	Shield Plate	Split Pin	Grease Cap
KF 261	X	X	1	F		1				1					
KB 262	X		1	B		1				1					
KB 263		X	1	B							1				
KF 264	X	X	1	F		1				1					
KC 265		X	1	C					1		1				
KA 266		X	1	A	1						2				
KV 267		X	1	V										2	
KA 268		X	1	A							2	1			
KA 269		X	2	A		1					1				
KF 270	X		1	F		1				1					
KV 271	X		1	V		2	6								
KA 272	X		2	A		1					2				
KA 273	X		2	A							1		2		
KF 274		X	1	F		1				1					
KV 275		X	1	V		1									
KV 276		X	1	V											
KF 277	X		1	F		1				1					
KB 278	X		1	B		1				1					
KV 279		X	1	V		4									
KF 280	X	X	1	F		1				1					
KF 281	X		1	F		1				1					
KF 282	X		1	F		1				1					
KF 283	X		1	F		1				1					
KV 284		X	1	V		1									1
KV 285	X		1	V		1									1
KV 286		X	1	V		1									1
KV 287	X		1	V		1									
KF 288	X	X	1	F		1				1					
KF 289	X		1	F		1				1					
KV 290		X	1	V		1									1
KV 291	X		1	V	1	1	5								
KF 292	X		1	F						2				1	
KB 293	X		1	B		1				1					
KV 294		X	1	V		1									1
KB 295	X		1	B		1				1					1
KB 296	X		1	B		1				1					1
KV 297	X		1	V		1									1
KF 298	X		1	F						1	1			1	
KF 299	X		1	F						1				1	
KF 300		X	1	F		1				1					
KF 301	X		1	F						1	2			1	
KF 302	X		1	F		1				1					
KF 303		X	1	F		1				1					
KF 304	X		1	F											
KV 305		X	1	V		1		1					1		1
KF 306	X		1	F		4	1								
KF 307		X	1	F		4	3			2					
KF 308	X		1	F			1								
KF 309	X		1	F		1				1					
KF 310	X		1	F						1	2			1	
KF 311	X		1	F		1				1					
KF 312	X		1	F		1				1					



A



B



C



D















F



V

09. Content of the kits (Bill of material)

															
Fersa KIT	FRONT WHEEL	REAR WHEEL	BEARINGS	TYPE	Locking Washer	Nut	Screw	Spacer	Locking	Circlip	Oil Seal	O-Ring Gasket	Shield Plate	Split Pin	Grease Cap
KF 313	X		1	F						1				1	
KF 314	X		1	F		1									
KF 315	X		1	F		1									
KF 316	X	X	1	F										2	
KF 317	X		1	F						1	2			1	
KB 318	X		1	B		1				1	1				
KF 319	X		1	F		1				1					
KF 320	X		1	F		1				1					
KF 321	X		1	F						1	2			2	
KV 322	X		1	V			1								
KV 323		X	1	V		1									
KV 324		X	1	V		1									
KV 325		X	1	V		1									
KV 326		X	1	V		1									
KF 327	X		1	F		1				1					
KV 328		X	1	V			4								
KF 329	X		1	F		1									
KV 330		X	1	V		4									
KV 331		X	1	V		4									
KV 332	X		1	V		1	3								1
KV 333	X		1	V		1	3								1
KF 334	X		1	F	1	1									
KV 335	X		1	V		1	3								1
KV 336		X	1	V		4									
KV 337		X	1	V		1									1
KB 338		X	1	B		1				1					1
KB 339		X	1	B		1				1					
KF 340	X		1	F		1							1		
KF 341		X	1	F						1					1
KF 342	X		1	F		1				1					
KV 343	X		1	V		1	3								1
KB 344		X	1	B		1				1					1
KB 345		X	1	B		1				1					
KF 346	X		1	F		1				1					
KA 347		X	2	A		1					2				
KF 348		X	1	F		1				1					
KA 349	X		2	A							1			1	
KB 350		X	1	B		1				1					1
KF 351	X		1	F		1				1			1		
KF 352		X	1	F		1					1	1			
KV 353		X	1	V											
KF 354	X		1	F		1				1					







# 10/ Cross references lists

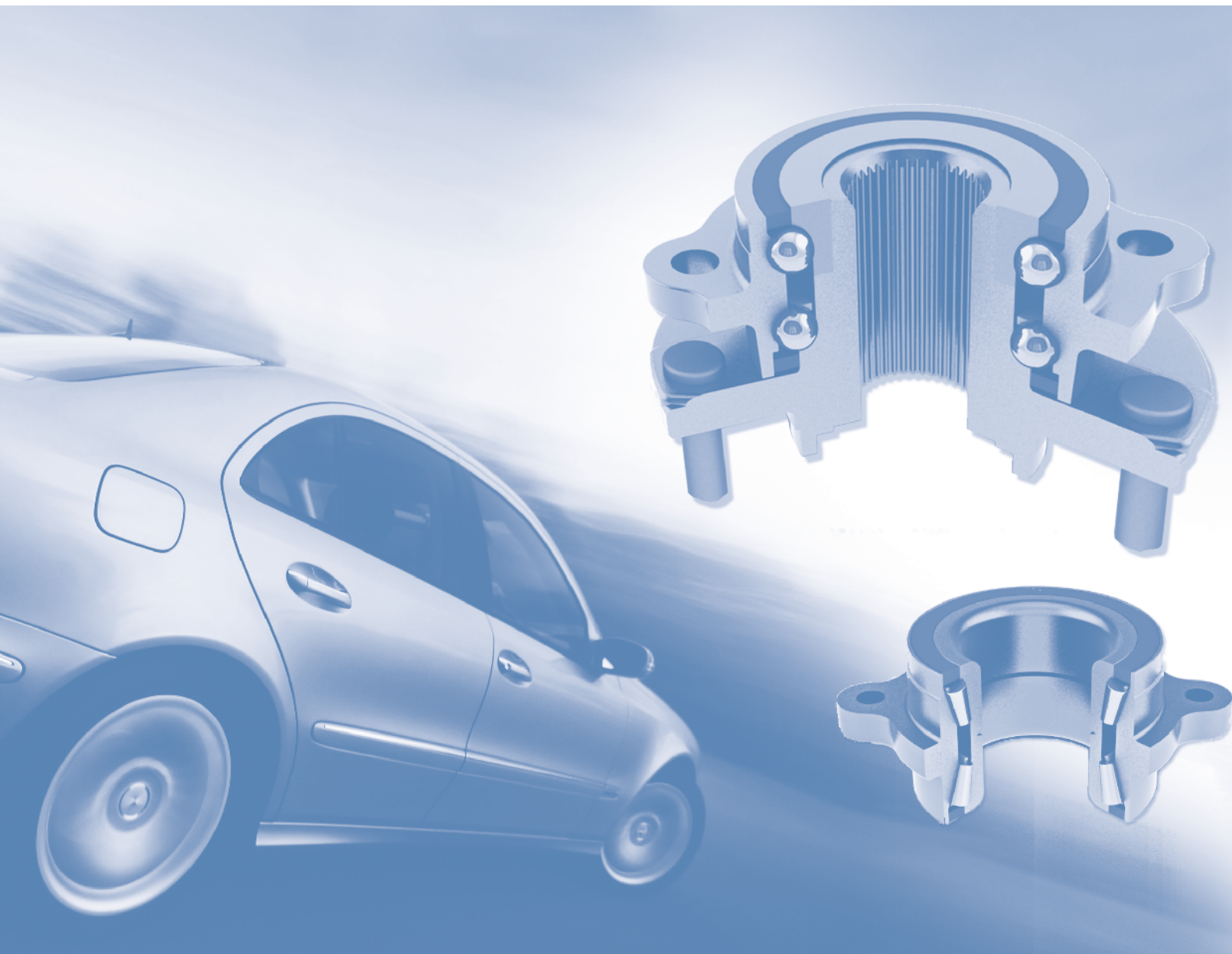





## 10 Cross references lists

---

<b>10.1 - Fersa Kit ↔ OEM</b>	<b>248</b>
<b>10.2 - Fersa Kit ↔ Other manufacturers</b>	<b>254</b>
<b>10.3 - Fersa Kit ↔ Fersa bearing</b>	<b>266</b>

---

## OEM

ALFA ROMEO	Fersa
60815880	KF 166
60815882	KF 264
60815883	KV 164
60815902	KF 283
60816007	KV 251
60812057	KV 237

AUDI	Fersa
171498625	KF 179
171498625A	KF 179
171498625B	KF 179
171498625C	KF 179
171498625D	KF 179
191498625	KF 181
191598625	KA 006
191498625A	KF 182
1D0498625B	KF 098
1H0498625	KF 183
1J0498625	KF 184
1J0598477	KV 097
1J0598625	KF 184
281498625	KA 071
2D0498625	KA 273
311498071BS	KA 006
321498625B	KF 095
321498625C	KF 095
321498625D	KF 095
321498625E	KF 095
331598625	KF 095
331598625A	KF 182
331598625B	KF 182
357498625	KF 182
357498625B	KF 182
443498625A	KF 098
443498625F	KF 098
4A0498625	KF 098
4A0598625	KA 005
4A0598625A	KA 005
4B0498625	KF 096
4B0498625A	KF 098
6N0498625	KF 181
6Q0598611	KV 286
6U0598625	KA 006
701498625	KF 233
701598625A	KF 233
7D0498625	KF 233
7M0498625	KF 240
871498625A	KF 180
893498625	KF 096
893 498 625 A	KF 096
893 498 625 B	KF 096
893498625C	KF 098
893498625D	KF 096
893498625E	KF 098
8A0498625	KF 096
8D0498625	KF 096
8D0498625A	KF 308

AUDI	Fersa
8D0498625B	KF 098
8D0498625C	KV 250
8D0598625	KA 248
8D0598625A	KF 096
8E0498625A	KV 250
8E0498625B	KV 250
8E0598625B	KV 250
321498625A	KF 095
443498625F	KF 307
4B0598625B	KF 098
6E0407621C	KV 285
6Q0407621AH	KV 287
6Q0407621AJ	KV 287
861498625	KF 180
871498625	KF 180
893498625A	KF 096
893498625B	KF 096

BMW	Fersa
1093427	KV 238
1095616	KV 238
1128157	KV 105
1128569	KV 105
1131297	KV 105
1139345	KV 108
31201095616	KV 238
31211128157	KV 105
31211128569	KV 105
31211131297	KV 105
31221093427	KV 238
31221139345	KV 108
31226757024	KV 297
6757024	KV 297

CITROËN	Fersa
00 17 540 300	KF 172
330756	KF 143
335002	KF 140
335007	KF 139
335012	KF 141
335016	KF 143
335017	KF 142
335018	KF 111
335019	KF 112
335021	KA 079
335024	KA 272
335025	KA 013
335026	KA 080
335027	KF 113
335028	KV 236
335029	KA 079
335030	KA 272
335031	KF 313
335032	KF 145
335069	KF 289
335072	KF 354
335084	KF 289

CITROËN	Fersa
335086	KF 354
370142	KV 144
370167	KV 275
374804	KA 088
374805	KA 088
374809	KA 041
374810	KA 073
374811	KA 089
374813	KA 073
374814	KA 089
374815	KV 144
374817	KB 008
374828	KV 114
374837	KV 305
374839	KB 078
374874	KV 290
9555853	KB 011
95557561	KB 012
95562212	KA 073
95619160	KF 143
95619162	KV 144
95654074	KF 111
95654076	KF 142
95654077	KF 112
95654078	KB 008
335022	KA 058
335023	KA 200
335071	KV 294
370154	KV 215
374811	KA 088
374812	KA 089
374814	KA 088
374818	KV 219
374832	KV 219
374839	KB 008
374843	KV 114
95496146	KV 144
95603182	KF 111
95619170	KA 009
95619171	KA 010
95654075	KF 111
95669382	KA 080

DACIA	Fersa
6001547696	KF 155
6001548986	KB 193

FIAT	Fersa
5890986	KF 261
5890987	KF 166
5890988	KF 261
5890990	KF 165
5890993	KA 210
5890994	KV 163
5891194	KF 161
60815880	KF 166
60815882	KF 264

FIAT	Fersa
71714452	KA 080
71714454	KA 013
71714457	KF 283
71714458	KF 288
71714459	KF 346
71714460	KF 166
71714463	KV 251
71714464	KF 281
71714466	KF 270
71714468	KF 168
71714471	KV 251
71714472	KF 264
71714473	KF 113
71714474	KV 236
71714476	KV 164
71714477	KV 164
71714480	KF 167
71737189	KV 251
71737612	KV 164
71737613	KV 164
71737614	KV 251
71753061	KF 283
71753062	KF 346
9403350718	KV 294
9567217680	KF 113
9567217780	KV 236
07769902	KV 237
71714450	KA 079
71714455	KF 161
71714468	KF 165
7171454	KA 013
71732444	KA 091
7603485	KV 162
95555853	KB 011
95557561	KB 012

FORD	Fersa
1001718	KF 240
1001719	KF 241
1019561	KA 021
1053115	KA 085
1085565	KB 191
1104362	KF 241
1112547	KF 282
1133023	KF 329
1135043	KB 191
1137830	KA 021
1141771	KF 115
1201300	KV 291
1201303	KV 326
1201568	KB 191
1201569	KF 282
1318151	KV 323
1318154	KV 324
1377910	KV 325
1587548	KF 288
1587565	KF 283

FORD	Fersa
1587590	KV 251
5007026	KA 017
5007027	KA 014
5007028	KA 016
5007029	KA 083
5007036	KD 117
5007037	KA 074
5007039	KA 015
5007040	KA 019
5008716	KA 018
5010762	KA 081
5011391	KA 082
5011392	KA 076
5012347	KA 347
5012478	KA 257
5015587	KD 118
5015650	KA 084
5020654	KA 021
5020655	KA 021
5020656	KA 020
5024195	KA 020
5024196	KF 115
5025899	KA 085
5025901	KB 263
5027620	KF 116
5027621	KV 220
5027622	KV 221
5027624	KV 222
5030538	KA 021
1057808	KV 221
1085569	KF 282
1088380	KF 115
1115019	KV 328
1146689	KV 328
1201304	KV 326
1333562	KF 115
4052783	KV 291
5011391	KA 076
5015586	KD 117
5015587	KD 117
5030537	KA 021
93BX1K018AA	KF 329

GM	Fersa
09111942	KA 269
09117616	KV 196
09117620	KV 198
09117621	KV 247
09117622	KV 199
09120273	KV 279
09196286	KB 338
90005137	KA 040
90005147	KA 007
90016721	KA 039
90486457	KA 039
90486458	KF 133
90486460	KF 134

GM	Fersa
90486463	KA 007
90486467	KV 135
90486468	KF 136
90510542	KF 138
90510543	KV 252
90510544	KF 137
90510629	KV 202
90511494	KV 235
90540069	KV 202
90540262	KV 235
9111023	KB 278
91159917	KB 339
91160086	KF 340
91160087	KF 315
9161454	KB 293
9195608	KF 292
9196298	KV 337
93161059	KF 334
93171495	KV 343
93175327	KV 343
93178625	KV 330
93178626	KV 331
93178651	KV 333
93178652	KV 332
93186388	KV 335

LANCIA	Fersa
71737189	KV 251
71714459	KF 346
71714468	KF 165
71714471	KV 251
71714473	KF 113
71714474	KV 236
71714477	KV 164

MERCEDES-BENZ	Fersa
000 980 05 16	KB 300
1153300051	KA 025
1155860235	KA 026
1155860333	KA 025
1155860835	KA 026
1155861135	KA 026
1163300051	KA 027
1165860033	KA 027
1233500068	KA 026
1235860035	KA 026
1243300251	KA 189
1243300351	KA 189
1243300551	KA 189
1243500549	KB 125
1243500649	KB 125
1243500749	KF 124
1249800416	KB 125
1249800516	KB 125
1263300051	KA 029
1293300051	KA 189
1293300151	KA 189

## OEM

MERCEDES-BENZ	Fersa
1293300251	KA 189
1293500049	KF 124
1299800016	KF 124
1299800116	KF 124
1299800216	KF 124
1299800316	KF 124
1299800416	KF 124
1409800616	KB 300
1409800716	KB 300
1633300051	KF 280
2013300151	KA 030
2013300251	KA 028
2013500149	KF 124
2013500249	KF 124
2013500549	KF 124
2019800016	KF 124
2019800116	KF 124
2023300051	KA 189
2029800016	KF 124
2029800116	KF 124
2039800016	KF 124
2103300051	KA 189
2103300325	KA 189
2109800116	KB 300
2109800516	KB 300
2209800016	KB 300
2209800116	KB 300
6013500468	KA 126
6013501510	KA 126
6043300025	KA 273
6113300725	KA 027
6113300825	KA 273
1293300351	KA 189
6313300051	KA 033
6313300251	KA 033

OPEL	Fersa
1603049	KA 040
1603065	KA 038
1603109	KA 039
1603143	KV 343
1603191	KF 134
1603192	KF 133
1603193	KA 038
1603194	KV 135
1603195	KF 137
1603196	KF 138
1603208	KV 196
1603209	KV 198
1603210	KV 247
1603211	KV 199
1603243	KV 343
1603253	KV 333
1603254	KV 332
1603255	KV 335
1603294	KV 343
1603295	KV 335

OPEL	Fersa
1604002	KV 252
1604003	KV 202
1604004	KV 235
1604005	KV 279
1604007	KB 338
1604286	KA 039
1604292	KF 136
1604301	KV 252
1604302	KV 202
1604303	KV 235
1604306	KV 202
1604307	KV 235
1604314	KV 336
1604315	KV 330
1604316	KV 331
1607286	KA 039
328980	KF 292
420240	KV 337
4403023	KB 293
4403044	KB 344
4408277	KB 339
4408668	KF 340
4408669	KF 315
4412598	KF 334
4430305	KF 334
4501154	KB 278
90005137	KA 040
90005147	KA 038
90016721	KA 039
90486457	KA 039
90486458	KF 133
90486460	KF 134
90486463	KA 038
90486467	KV 135
90486468	KF 136
90510542	KF 138
90510543	KV 252
90510544	KF 137
90510629	KV 202
90511494	KV 235
90540069	KV 202
90540262	KV 235
9111023	KB 293
9111044	KB 344
91159917	KB 339
91160086	KF 340
91160087	KF 315
9117619	KV 196
9117620	KV 198
9117621	KV 247
9117622	KV 199
9119931	KV 252
9120128	KV 202
9120129	KV 235
9120273	KV 279
9161454	KB 278
9195608	KF 292

OPEL	Fersa
9196286	KB 338
9196298	KV 337
93161059	KF 334
93161376	KF 334
93170611	KV 336
93171495	KV 343
93175327	KV 343
93178625	KV 330
93178626	KV 331
93178651	KV 333
93178652	KV 332
93178661	KV 335
93186387	KV 343
93186388	KV 335
0421000	KV 202
09111942	KA 269
09117616	KV 196
09117620	KV 198
09117621	KV 247
09117622	KV 199
09120273	KV 279
09196286	KB 338
1603065	KA 007
1603193	KA 007
328103	KF 134
328104	KF 133
4403023	KB 278
4403942	KA 269
4501154	KB 293
9111023	KB 278
9161454	KB 293

PEUGEOT	Fersa
00 17 540 300	KF 172
330756	KF 143
335002	KF 140
335007	KF 139
335012	KF 141
335016	KF 143
335017	KF 142
335018	KF 111
335019	KF 112
335021	KA 079
335024	KA 272
335025	KA 013
335026	KA 080
335027	KF 113
335028	KV 236
335029	KA 079
335030	KA 272
335031	KF 313
335069	KF 289
335071	KV 294
335092	KF 354
370142	KV 144
370167	KV 275
374804	KA 088

PEUGEOT	Fersa
374805	KA 088
374809	KA 041
374810	KA 073
374811	KA 089
374813	KA 073
374814	KA 089
374815	KV 144
374817	KB 008
374828	KV 114
374832	KV 219
374874	KV 290
95555853	KB 011
95557561	KB 012
95562212	KA 073
95619160	KF 143
95619162	KV 144
95654074	KF 111
95654076	KF 142
95654077	KF 112
95654078	KB 008
335022	KA 058
335023	KA 200
335032	KF 145
335072	KF 354
370154	KV 215
374811	KA 088
374812	KA 089
374814	KA 088
374818	KV 219
374837	KV 305
374839	KB 008
374843	KV 114
95619170	KA 009
95619171	KA 010
95669382	KA 080

RENAULT	Fersa
6025370536	KF 312
7701204666	KV 157
7701204667	KV 258
7701204689	KV 244
7701204690	KV 243
7701204696	KV 156
7701205170	KV 246
7701205416	KB 278
7701205596	KB 047
7701205692	KF 153
7701205778	KB 048
7701205779	KF 155
7701205780	KF 195
7701205812	KB 193
7701205972	KF 277
7701206740	KB 293
7701206742	KB 344
7701206847	KF 340
7701206848	KF 315
7701206849	KB 339

RENAULT	Fersa
7701207358	KF 334
7701207677	KF 351
7701207966	KF 334
7701208058	KB 350
7701208427	KF 334
7701460637	KC 148
7701460638	KC 147
7701460639	KC 149
7701460640	KA 042
7701460641	KA 043
7701460642	KA 044
7701461046	KC 146
7701461730	KA 091
7701462019	KF 150
7701462020	KV 152
7701462021	KF 153
7701463231	KV 152
7701463523	KB 090
7701463940	KA 049
7701463986	KB 046
7701463987	KB 047
7701464049	KF 155
7701465646	KA 269
7701468409	KA 255
7701469682	KF 312
7704002263	KV 258
6025371670	KF 312
7700780919	KV 156
7700780921	KV 157
7700787639	KB 046
7700820849	KV 244
7700820850	KV 243
7700841979	KB 048
7701204665	KB 046
7701205416	KB 293
7701205779	KF 158
7701205780	KF 155
7701205812	KB 045
7701206740	KB 278
7701462469	KB 048
7701464049	KF 158
7701465181	KB 048
7701465735	KB 045
7701466803	KF 155
7701467860	KF 155
7701470552	KF 277
7703090325	KB 046
8671006208	KF 134
8671006217	KA 073
8671006220	KF 142
8671006223	KV 144
8671006224	KF 143

ROVER	Fersa
GHK 1140	KA 254
GHK 1559	KF 101
GHK 1933	KF 099

ROVER	Fersa
RFM 000060	KF 099
RUD 100070	KF 101

SAAB	Fersa
93170611	KV 336
93175327	KV 343
93186387	KV 343

SEAT	Fersa
1J0498625	KF 184
1J0598477	KV 097
1J0598625	KF 184
357 498 625 B	KF 182
3981586	KV 163
3981588	KF 203
3981589	KF 203
3981590	KF 161
3981591	KA 055
3981592	KA 057
3981594	KV 162
3981595	KC 253
6N0 498 625	KF 181
6Q0 598 611	KV 286
6X0 598 477	KV 284
7M0 498 625	KF 240
7M0 598 625 A	KF 241
7M3 498 625	KF 240
SE021140301A	KF 203
SE021140301B	KF 203
SE021149002A	KV 162
SE025140301A	KF 161
SE028140301A	KV 163
SE028160302A	KV 204
021149002A	KV 162
191498625A	KF 182
191598625	KA 006
1H0498625	KF 183
357498625	KF 182
357498625A	KF 183
357498625B	KF 182
3981593	KV 204
4A0598625	KA 005
4A0598625A	KA 005
6N0498625	KF 181
6Q0407621AH	KV 287
6Q0407621AJ	KV 287
6U0598625	KA 006
6X0598477	KV 284
7M0498625	KF 240
7M0598625	KF 241
7M3498625	KF 240
7M3598625	KF 241
8D0598625	KA 248

SKODA	Fersa
1J0 498 625	KF 184
1J0 598 477	KV 097

## OEM

SKODA	Fersa
1J0 598 625	<b>KF 184</b>
4A0 498 625	<b>KF 098</b>
4B0 498 625	<b>KF 096</b>
6Q0 598 611	<b>KV 286</b>
191598625	<b>KA 006</b>
1J0498625	<b>KF 184</b>
4A0498625	<b>KF 098</b>
4B0498625	<b>KF 096</b>
6Q0407621AH	<b>KV 287</b>
6Q0407621AJ	<b>KV 287</b>
6U0598625	<b>KA 006</b>
8D0498625	<b>KF 096</b>

VAUXHALL	Fersa
1603049	<b>KA 040</b>
1603065	<b>KA 038</b>
1603109	<b>KA 039</b>
1603143	<b>KV 343</b>
1603191	<b>KF 134</b>
1603192	<b>KF 133</b>
1603193	<b>KA 038</b>
1603194	<b>KV 135</b>
1603195	<b>KF 137</b>
1603196	<b>KF 138</b>
1603208	<b>KV 196</b>
1603209	<b>KV 198</b>
1603210	<b>KV 247</b>
1603211	<b>KV 199</b>
1603243	<b>KV 343</b>
1603255	<b>KV 335</b>
1603294	<b>KV 343</b>
1603295	<b>KV 335</b>
1604002	<b>KV 252</b>
1604003	<b>KV 202</b>
1604004	<b>KV 235</b>
1604005	<b>KV 279</b>
1604007	<b>KB 338</b>
1604286	<b>KA 039</b>
1604292	<b>KF 136</b>
1604301	<b>KV 252</b>
1604302	<b>KV 202</b>
1604303	<b>KV 235</b>
1604306	<b>KV 202</b>
1604307	<b>KV 235</b>
1604314	<b>KV 336</b>
1607286	<b>KA 039</b>
328980	<b>KF 292</b>
420240	<b>KV 337</b>
4403023	<b>KB 293</b>
4403044	<b>KB 344</b>
4408277	<b>KB 339</b>
4408668	<b>KF 340</b>
4408669	<b>KF 315</b>
4412598	<b>KF 334</b>
4430305	<b>KF 334</b>
4501154	<b>KB 278</b>

VAUXHALL	Fersa
90005137	<b>KA 040</b>
90005147	<b>KA 038</b>
90016721	<b>KA 039</b>
90486457	<b>KA 039</b>
90486458	<b>KF 133</b>
90486460	<b>KF 134</b>
90486463	<b>KA 038</b>
90486467	<b>KV 135</b>
90486468	<b>KF 136</b>
90510542	<b>KF 138</b>
90510543	<b>KV 252</b>
90510544	<b>KF 137</b>
90510629	<b>KV 202</b>
90511494	<b>KV 235</b>
90540069	<b>KV 202</b>
90540262	<b>KV 235</b>
9111023	<b>KB 293</b>
9111044	<b>KB 344</b>
91159917	<b>KB 339</b>
91160086	<b>KF 340</b>
91160087	<b>KF 315</b>
9117619	<b>KV 196</b>
9117620	<b>KV 198</b>
9117621	<b>KV 247</b>
9117622	<b>KV 199</b>
9119931	<b>KV 252</b>
9120128	<b>KV 202</b>
9120129	<b>KV 235</b>
9120273	<b>KV 279</b>
9161454	<b>KB 278</b>
9195608	<b>KF 292</b>
9196286	<b>KB 338</b>
9196298	<b>KV 337</b>
93161059	<b>KF 334</b>
93161376	<b>KF 334</b>
93170611	<b>KV 336</b>
93171495	<b>KV 343</b>
93175327	<b>KV 343</b>
93178661	<b>KV 335</b>
93186387	<b>KV 343</b>
93186388	<b>KV 335</b>
09111942	<b>KA 269</b>
09117616	<b>KV 196</b>
09117620	<b>KV 198</b>
09117621	<b>KV 247</b>
09117622	<b>KV 199</b>
09120273	<b>KV 279</b>
09196286	<b>KB 338</b>
90005147	<b>KA 007</b>
90486463	<b>KA 007</b>
9111023	<b>KB 278</b>
9161454	<b>KB 293</b>
93178625	<b>KV 330</b>
93178626	<b>KV 331</b>
93178651	<b>KV 333</b>
93178652	<b>KV 332</b>

VOLKSWAGEN	Fersa
171498625	<b>KF 179</b>
171498625A	<b>KF 179</b>
171498625B	<b>KF 179</b>
171498625C	<b>KF 179</b>
171498625D	<b>KF 179</b>
191498625	<b>KF 181</b>
191498625A	<b>KF 182</b>
191598625	<b>KA 006</b>
1H0498625	<b>KF 183</b>
1J0498625	<b>KF 184</b>
281498625	<b>KA 071</b>
2D0498625	<b>KA 273</b>
321498625A	<b>KF 095</b>
321498625C	<b>KF 095</b>
321498625D	<b>KF 095</b>
321498625E	<b>KF 095</b>
331598625	<b>KF 095</b>
331598625A	<b>KF 182</b>
357498625	<b>KF 182</b>
357498625A	<b>KF 183</b>
357498625B	<b>KF 182</b>
4A0498625	<b>KF 098</b>
4A0598625	<b>KA 005</b>
4A0598625A	<b>KA 005</b>
4B0498625	<b>KF 096</b>
6E0407621C	<b>KV 285</b>
6N0498625	<b>KF 181</b>
6Q0407621AH	<b>KV 287</b>
6Q0407621AJ	<b>KV 287</b>
6U0598625	<b>KA 006</b>
6X0598477	<b>KV 284</b>
701498625	<b>KF 233</b>
701598625	<b>KF 233</b>
701598625A	<b>KF 233</b>
7D0498625	<b>KF 233</b>
7M0498625	<b>KF 240</b>
7M0598625	<b>KF 241</b>
7M3498625	<b>KF 240</b>
7M3598625	<b>KF 241</b>
861498625	<b>KF 180</b>
871498625	<b>KF 180</b>
871498625A	<b>KF 180</b>
893498625	<b>KF 096</b>
893498625A	<b>KF 096</b>
893498625B	<b>KF 096</b>
893498625D	<b>KF 096</b>
8A0498625	<b>KF 096</b>
8D0498625	<b>KF 096</b>
8D0598625	<b>KA 248</b>
1D0498625B	<b>KF 098</b>
1J0598477	<b>KV 097</b>
1J0598625	<b>KF 184</b>
311498071BS	<b>KA 006</b>
321498625B	<b>KF 095</b>
331598625B	<b>KF 182</b>
443498625A	<b>KF 098</b>

VOLKSWAGEN	Fersa
443498625F	<b>KF 098</b>
4B0498625A	<b>KF 098</b>
6Q0598611	<b>KV 286</b>
7M0598625A	<b>KF 241</b>
893498625	<b>KF 096</b>
893498625C	<b>KF 098</b>
893498625E	<b>KF 098</b>
8D0498625A	<b>KF 308</b>
8D0498625B	<b>KF 098</b>

VOLVO	Fersa
271262	<b>KA 212</b>
271795	<b>KV 234</b>
272456	<b>KV 249</b>
273747	<b>KA 068</b>
273872	<b>KA 211</b>
274378	<b>KV 271</b>
2712628	<b>KA 212</b>
271781	<b>KV 245</b>
271786	<b>KV 245</b>
2717866	<b>KV 245</b>
2717957	<b>KV 234</b>
2737476	<b>KA 068</b>
2738722	<b>KA 211</b>
30812651	<b>KV 242</b>
30819062	<b>KV 242</b>
9173872	<b>KV 177</b>



## FAG - Fersa

FAG	Fersa
713606020	KA 002
713606050	KA 004
713606120	KA 002
713606140	KA 003
713606160	KF 094
713606200	KA 001
713606260	KF 092
713606260	KF 093
713610020	KF 184
713610030	KF 098
713610040	KF 183
713610050	KF 098
713610070	KF 308
713610080	KF 096
713610090	KF 098
713610100	KF 182
713610100	KF 216
713610130	KF 180
713610140	KF 179
713610160	KF 095
713610160	KF 185
713610170	KF 096
713610180	KF 181
713610210	KV 284
713610220	KV 194
713610230	KA 006
713610230	KA 069
713610240	KA 005
713610290	KF 096
713610300	KF 233
713610310	KF 181
713610320	KV 284
713610340	KF 233
713610360	KF 098
713610370	KA 248
713610380	KV 250
713610390	KV 250
713610400	KF 233
713610410	KF 307
713610420	KF 098
713610420	KF 306
713610430	KV 250
713610450	KF 240
713610460	KF 241
713610470	KV 287
713610490	KV 286
713610500	KV 276
713610530	KV 285
713610730	KF 182
713611480	KA 071
713611550	KC 256
713611570	KA 072
713613040	KF 130
713613070	KA 131
713613090	KF 129
713613130	KA 036

FAG	Fersa
713613160	KA 035
713613210	KB 217
713613220	KC 132
713613230	KA 077
713613280	KA 034
713613410	KA 266
713613420	KC 132
713613490	KF 318
713613590	KA 268
713613630	KF 321
713613640	KV 267
713613700	KF 128
713613710	KF 128
713614010	KA 349
713614030	KF 159
713614200	KD 348
713614210	KA 054
713615030	KF 227
713615090	KF 225
713615150	KA 214
713615510	KV 226
713615530	KV 232
713617030	KF 304
713617040	KF 102
713617070	KV 229
713617090	KF 099
713617160	KF 320
713617260	KV 100
713617270	KV 260
713617360	KF 101
713618040	KF 310
713618100	KA 065
713618110	KA 066
713618150	KF 259
713618180	KF 316
713618210	KC 174
713618250	KF 352
713618270	KF 173
713618300	KA 070
713618550	KF 298
713618560	KF 197
713618740	KA 067
713618760	KF 309
713618790	KF 311
713619050	KV 230
713619060	KV 231
713619080	KV 120
713619090	KD 119
713619100	KA 086
713619130	KA 022
713619140	KA 190
713619150	KF 317
713619170	KD 121
713619210	KC 188
713619230	KA 187
713619240	KA 186

FAG	Fersa
713619280	KV 228
713619290	KA 186
713619300	KA 023
713619410	KV 122
713619420	KV 123
713619450	KV 336
713619510	KF 299
713620010	KA 052
713620020	KA 053
713620130	KA 254
713620140	KA 050
713623020	KA 061
713623030	KB 062
713623050	KC 223
713623060	KF 301
713623090	KC 265
713623120	KC 224
713623130	KC 224
713630030	KF 158
713630050	KF 155
713630050	KF 195
713630060	KF 313
713630090	KV 275
713630100	KC 146
713630120	KC 147
713630130	KC 148
713630150	KC 149
713630160	KF 150
713630170	KV 152
713630180	KB 048
713630180	KF 151
713630180	KB 192
713630180	KB 262
713630200	KA 042
713630210	KA 043
713630220	KA 044
713630240	KB 046
713630250	KB 090
713630260	KB 046
713630270	KB 047
713630300	KB 045
713630300	KB 193
713630310	KV 157
713630330	KA 255
713630340	KF 153
713630350	KV 156
713630370	KF 314
713630380	KV 258
713630440	KA 091
713630480	KA 049
713630530	KV 114
713630540	KV 305
713630550	KA 269
713630560	KV 258
713630570	KV 236
713630580	KF 113

## FAG - Fersa

FAG	Fersa
713630630	<b>KV 243</b>
713630640	<b>KV 244</b>
713630650	<b>KV 246</b>
713630710	<b>KF 312</b>
713630760	<b>KF 289</b>
713630780	<b>KB 344</b>
713630790	<b>KB 278</b>
713630800	<b>KB 293</b>
713630820	<b>KV 290</b>
713630830	<b>KF 277</b>
713630840	<b>KF 351</b>
713630950	<b>KB 350</b>
713640010	<b>KV 294</b>
713640040	<b>KA 091</b>
713640180	<b>KF 143</b>
713640190	<b>KF 111</b>
713640250	<b>KV 219</b>
713640260	<b>KV 144</b>
713640280	<b>KF 112</b>
713640310	<b>KF 354</b>
713640390	<b>KA 079</b>
713640390	<b>KB 295</b>
713640400	<b>KA 272</b>
713640400	<b>KB 296</b>
713640440	<b>KA 089</b>
713644020	<b>KV 279</b>
713644030	<b>KV 247</b>
713644040	<b>KV 196</b>
713644060	<b>KV 199</b>
713644070	<b>KV 198</b>
713644080	<b>KF 292</b>
713644090	<b>KV 343</b>
713644100	<b>KF 342</b>
713644110	<b>KF 341</b>
713644120	<b>KF 340</b>
713644130	<b>KF 315</b>
713644140	<b>KB 339</b>
713644150	<b>KF 137</b>
713644160	<b>KF 133</b>
713644170	<b>KF 134</b>
713644190	<b>KF 138</b>
713644220	<b>KB 338</b>
713644230	<b>KV 337</b>
713644260	<b>KV 336</b>
713644270	<b>KV 335</b>
713644290	<b>KF 334</b>
713644300	<b>KF 319</b>
713644310	<b>KV 333</b>
713644320	<b>KV 332</b>
713644330	<b>KV 331</b>
713644340	<b>KV 330</b>
713644480	<b>KA 040</b>
713644510	<b>KA 007</b>
713644510	<b>KA 038</b>
713644520	<b>KA 039</b>
713644540	<b>KV 135</b>

FAG	Fersa
713644550	<b>KV 235</b>
713644560	<b>KV 202</b>
713644570	<b>KV 252</b>
713644650	<b>KF 136</b>
713649240	<b>KF 104</b>
713649250	<b>KF 107</b>
713649270	<b>KF 106</b>
713649280	<b>KF 274</b>
713649290	<b>KF 107</b>
713649300	<b>KF 110</b>
713649320	<b>KF 109</b>
713649340	<b>KV 239</b>
713650060	<b>KF 145</b>
713650070	<b>KB 008</b>
713650070	<b>KB 078</b>
713650090	<b>KF 112</b>
713650110	<b>KF 139</b>
713650140	<b>KA 041</b>
713650160	<b>KF 142</b>
713650210	<b>KA 088</b>
713650210	<b>KA 089</b>
713650240	<b>KF 140</b>
713650250	<b>KV 215</b>
713650260	<b>KF 141</b>
713650270	<b>KA 073</b>
713650290	<b>KB 008</b>
713650310	<b>KA 079</b>
713650330	<b>KA 272</b>
713650410	<b>KA 058</b>
713650420	<b>KA 013</b>
713650430	<b>KA 080</b>
713660040	<b>KV 245</b>
713660040	<b>KV 271</b>
713660050	<b>KF 176</b>
713660080	<b>KV 234</b>
713660110	<b>KA 068</b>
713660120	<b>KV 242</b>
713660130	<b>KF 302</b>
713660190	<b>KF 175</b>
713660230	<b>KA 211</b>
713660260	<b>KA 212</b>
713660270	<b>KV 178</b>
713660280	<b>KV 177</b>
713660310	<b>KV 249</b>
713660370	<b>KV 245</b>
713660410	<b>KV 178</b>
713667050	<b>KF 127</b>
713667060	<b>KV 297</b>
713667140	<b>KV 105</b>
713667180	<b>KV 108</b>
713667220	<b>KV 238</b>
713667230	<b>KF 303</b>
713667300	<b>KA 033</b>
713667320	<b>KB 345</b>
713667360	<b>KA 189</b>
713667370	<b>KA 028</b>

FAG	Fersa
713667380	<b>KA 087</b>
713667400	<b>KA 025</b>
713667420	<b>KA 029</b>
713667430	<b>KA 027</b>
713667450	<b>KA 030</b>
713667470	<b>KA 189</b>
713667520	<b>KA 026</b>
713667530	<b>KF 124</b>
713667540	<b>KF 124</b>
713667550	<b>KB 125</b>
713667560	<b>KA 126</b>
713667570	<b>KA 032</b>
713667580	<b>KB 125</b>
713667600	<b>KA 273</b>
713667720	<b>KF 124</b>
713667730	<b>KB 300</b>
713667740	<b>KF 280</b>
713667750	<b>KB 300</b>
713667830	<b>KF 124</b>
713667860	<b>KB 300</b>
713667870	<b>KF 124</b>
713667880	<b>KB 300</b>
713667890	<b>KB 300</b>
713678020	<b>KA 020</b>
713678030	<b>KB 191</b>
713678040	<b>KF 115</b>
713678040	<b>KF 327</b>
713678050	<b>KF 116</b>
713678080	<b>KA 018</b>
713678080	<b>KA 081</b>
713678090	<b>KA 019</b>
713678100	<b>KF 282</b>
713678110	<b>KF 201</b>
713678140	<b>KA 017</b>
713678150	<b>KA 016</b>
713678150	<b>KA 075</b>
713678170	<b>KA 074</b>
713678190	<b>KA 015</b>
713678250	<b>KA 014</b>
713678280	<b>KA 076</b>
713678280	<b>KA 082</b>
713678290	<b>KA 257</b>
713678290	<b>KA 347</b>
713678300	<b>KA 083</b>
713678320	<b>KA 021</b>
713678340	<b>KV 220</b>
713678350	<b>KV 221</b>
713678360	<b>KV 222</b>
713678380	<b>KD 117</b>
713678400	<b>KD 117</b>
713678400	<b>KD 118</b>
713678410	<b>KF 329</b>
713678420	<b>KA 084</b>
713678430	<b>KV 328</b>
713678500	<b>KA 085</b>
713678610	<b>KB 263</b>

## FAG - Fersa

FAG	Fersa
713678620	<b>KF 115</b>
713678630	<b>KF 282</b>
713678640	<b>KB 191</b>
713678650	<b>KV 291</b>
713678660	<b>KV 326</b>
713678670	<b>KV 325</b>
713678700	<b>KV 221</b>
713678720	<b>KV 324</b>
713678730	<b>KV 323</b>
713678750	<b>KA 081</b>
713678760	<b>KA 076</b>
713678770	<b>KA 347</b>
713678790	<b>KV 322</b>
713680160	<b>KF 172</b>
713690010	<b>KV 163</b>
713690070	<b>KF 261</b>
713690090	<b>KA 024</b>
713690110	<b>KA 213</b>
713690120	<b>KA 055</b>
713690130	<b>KA 056</b>
713690150	<b>KA 057</b>
713690160	<b>KF 161</b>
713690170	<b>KF 160</b>
713690190	<b>KC 205</b>
713690200	<b>KC 253</b>
713690210	<b>KA 210</b>
713690230	<b>KV 164</b>
713690240	<b>KV 162</b>
713690260	<b>KV 204</b>
713690300	<b>KF 283</b>
713690320	<b>KB 011</b>
713690330	<b>KA 009</b>
713690380	<b>KA 169</b>
713690420	<b>KB 012</b>
713690430	<b>KA 010</b>
713690470	<b>KA 170</b>
713690490	<b>KA 200</b>
713690500	<b>KF 165</b>
713690500	<b>KF 168</b>
713690510	<b>KF 166</b>
713690540	<b>KF 264</b>
713690550	<b>KV 237</b>
713690600	<b>KV 218</b>
713690610	<b>KF 167</b>
713690670	<b>KF 281</b>
713690710	<b>KV 251</b>
713690750	<b>KF 346</b>
713690780	<b>KF 270</b>
713690860	<b>KF 288</b>
713696100	<b>KF 203</b>
716618670	<b>KV 353</b>

## QH - Fersa

QH	Fersa
QWB 155C	<b>KA 038</b>
QWB 159C	<b>KA 254</b>
QWB 177C	<b>KC 253</b>
QWB 184C	<b>KA 074</b>
QWB 186C	<b>KA 050</b>
QWB 187C	<b>KA 050</b>
QWB 194C	<b>KD 117</b>
QWB 200	<b>KF 180</b>
QWB 201	<b>KA 006</b>
QWB 209	<b>KA 006</b>
QWB 211	<b>KA 001</b>
QWB 212	<b>KA 002</b>
QWB 231	<b>KF 172</b>
QWB 238	<b>KC 253</b>
QWB 239	<b>KA 055</b>
QWB 241	<b>KA 210</b>
QWB 242	<b>KA 056</b>
QWB 243	<b>KF 161</b>
QWB 247	<b>KA 057</b>
QWB 249	<b>KA 213</b>
QWB 254	<b>KC 205</b>
QWB 255	<b>KA 027</b>
QWB 256	<b>KA 025</b>
QWB 259	<b>KA 026</b>
QWB 285	<b>KA 040</b>
QWB 286	<b>KC 147</b>
QWB 289	<b>KA 041</b>
QWB 291	<b>KF 140</b>
QWB 301	<b>KA 042</b>
QWB 302	<b>KC 146</b>
QWB 302	<b>KC 148</b>
QWB 309	<b>KF 150</b>
QWB 310	<b>KA 044</b>
QWB 313	<b>KC 149</b>
QWB 328	<b>KF 179</b>
QWB 337	<b>KA 211</b>
QWB 342	<b>KA 068</b>
QWB 347	<b>KA 036</b>
QWB 354	<b>KC 132</b>
QWB 360	<b>KC 174</b>
QWB 361	<b>KA 002</b>
QWB 365	<b>KA 066</b>
QWB 365	<b>KA 067</b>
QWB 366	<b>KA 065</b>
QWB 375	<b>KA 086</b>
QWB 376	<b>KC 188</b>
QWB 406	<b>KC 256</b>
QWB 407	<b>KA 071</b>
QWB 411	<b>KA 051</b>
QWB 414	<b>KA 016</b>
QWB 414	<b>KA 083</b>
QWB 416	<b>KA 016</b>
QWB 417	<b>KF 133</b>
QWB 418	<b>KA 019</b>
QWB 419	<b>KA 050</b>
QWB 420	<b>KA 015</b>

QH	Fersa
QWB 421	<b>KV 162</b>
QWB 422	<b>KF 160</b>
QWB 422	<b>KF 203</b>
QWB 422	<b>KV 162</b>
QWB 429	<b>KA 005</b>
QWB 430D	<b>KB 048</b>
QWB 431	<b>KB 045</b>
QWB 436	<b>KF 134</b>
QWB 443	<b>KA 003</b>
QWB 444	<b>KA 066</b>
QWB 445	<b>KA 089</b>
QWB 446	<b>KA 088</b>
QWB 455	<b>KF 354</b>
QWB 457	<b>KA 211</b>
QWB 459	<b>KA 073</b>
QWB 461	<b>KF 141</b>
QWB 467	<b>KV 152</b>
QWB 474	<b>KA 255</b>
QWB 479	<b>KF 153</b>
QWB 481	<b>KA 009</b>
QWB 482	<b>KB 012</b>
QWB 486	<b>KB 011</b>
QWB 487	<b>KF 142</b>
QWB 488	<b>KV 144</b>
QWB 490	<b>KF 320</b>
QWB 492	<b>KA 077</b>
QWB 493	<b>KA 349</b>
QWB 494	<b>KC 256</b>
QWB 496	<b>KA 072</b>
QWB 497	<b>KA 091</b>
QWB 498	<b>KF 314</b>
QWB 500	<b>KV 144</b>
QWB 503	<b>KB 008</b>
QWB 507	<b>KF 139</b>
QWB 508	<b>KA 030</b>
QWB 509	<b>KV 204</b>
QWB 510	<b>KF 095</b>
QWB 512	<b>KF 181</b>
QWB 514	<b>KF 107</b>
QWB 515	<b>KV 163</b>
QWB 516	<b>KA 068</b>
QWB 519	<b>KA 052</b>
QWB 524	<b>KV 144</b>
QWB 525	<b>KF 143</b>
QWB 527	<b>KA 076</b>
QWB 528	<b>KA 082</b>
QWB 529	<b>KF 161</b>
QWB 532	<b>KA 347</b>
QWB 533	<b>KA 257</b>
QWB 534	<b>KV 105</b>
QWB 536	<b>KF 124</b>
QWB 539	<b>KA 034</b>
QWB 545	<b>KA 010</b>
QWB 556	<b>KA 077</b>
QWB 560	<b>KB 046</b>
QWB 560	<b>KB 047</b>

## QH - Fersa

QH	Fersa
QWB 561	<b>KF 143</b>
QWB 563	<b>KV 154</b>
QWB 563	<b>KV 157</b>
QWB 564	<b>KF 155</b>
QWB 566	<b>KB 046</b>
QWB 568	<b>KA 081</b>
QWB 569	<b>KA 018</b>
QWB 570	<b>KF 136</b>
QWB 576	<b>KV 103</b>
QWB 592	<b>KV 100</b>
QWB 596	<b>KA 039</b>
QWB 599	<b>KA 212</b>
QWB 603	<b>KV 135</b>
QWB 605	<b>KA 001</b>
QWB 608	<b>KA 049</b>
QWB 609	<b>KA 089</b>
QWB 610	<b>KA 041</b>
QWB 611	<b>KA 041</b>
QWB 618	<b>KV 100</b>
QWB 621	<b>KF 352</b>
QWB 622	<b>KF 173</b>
QWB 623	<b>KF 259</b>
QWB 625	<b>KA 065</b>
QWB 629	<b>KA 043</b>
QWB 633	<b>KD 118</b>
QWB 634	<b>KF 111</b>
QWB 635	<b>KF 112</b>
QWB 638	<b>KA 022</b>
QWB 647	<b>KD 348</b>
QWB 654	<b>KA 028</b>
QWB 658	<b>KA 266</b>
QWB 659	<b>KA 029</b>
QWB 660	<b>KA 030</b>
QWB 662	<b>KB 090</b>
QWB 666	<b>KA 169</b>
QWB 671	<b>KF 093</b>
QWB 672	<b>KF 092</b>
QWB 672	<b>KF 093</b>
QWB 673	<b>KV 162</b>
QWB 675	<b>KV 164</b>
QWB 678	<b>KV 215</b>
QWB 681	<b>KV 156</b>
QWB 683	<b>KA 057</b>
QWB 683	<b>KF 096</b>
QWB 685	<b>KA 170</b>
QWB 687	<b>KV 156</b>
QWB 691	<b>KA 004</b>
QWB 692	<b>KA 023</b>
QWB 693	<b>KA 070</b>
QWB 696	<b>KA 020</b>
QWB 697	<b>KA 021</b>
QWB 698	<b>KF 182</b>
QWB 703	<b>KF 173</b>
QWB 704	<b>KF 352</b>
QWB 705	<b>KA 067</b>
QWB 706	<b>KA 053</b>

QH	Fersa
QWB 707	<b>KA 054</b>
QWB 712	<b>KF 099</b>
QWB 715	<b>KA 086</b>
QWB 716	<b>KA 190</b>
QWB 718	<b>KA 171</b>
QWB 722	<b>KA 214</b>
QWB 725	<b>KA 024</b>
QWB 726	<b>KV 177</b>
QWB 733	<b>KF 098</b>
QWB 734	<b>KV 218</b>
QWB 735	<b>KF 261</b>
QWB 736	<b>KV 164</b>
QWB 740	<b>KA 058</b>
QWB 742	<b>KV 260</b>
QWB 743	<b>KF 099</b>
QWB 746	<b>KA 022</b>
QWB 747	<b>KA 186</b>
QWB 752	<b>KA 126</b>
QWB 754	<b>KB 125</b>
QWB 756	<b>KA 084</b>
QWB 759	<b>KF 175</b>
QWB 763	<b>KB 217</b>
QWB 766	<b>KF 259</b>
QWB 773	<b>KA 087</b>
QWB 779	<b>KF 106</b>
QWB 781	<b>KF 143</b>
QWB 782	<b>KB 008</b>
QWB 786	<b>KV 108</b>
QWB 786	<b>KV 297</b>
QWB 787	<b>KF 109</b>
QWB 794	<b>KF 165</b>
QWB 795	<b>KF 166</b>
QWB 796	<b>KA 006</b>
QWB 798	<b>KF 142</b>
QWB 799	<b>KB 008</b>
QWB 803	<b>KA 187</b>
QWB 805	<b>KV 100</b>
QWB 811	<b>KF 159</b>
QWB 812	<b>KB 062</b>
QWB 813	<b>KA 126</b>
QWB 815	<b>KA 035</b>
QWB 816	<b>KA 268</b>
QWB 817	<b>KF 115</b>
QWB 819	<b>KF 099</b>
QWB 823	<b>KF 182</b>
QWB 828	<b>KA 079</b>
QWB 830	<b>KV 219</b>
QWB 831	<b>KF 110</b>
QWB 835	<b>KF 143</b>
QWB 839	<b>KV 219</b>
QWB 842	<b>KA 086</b>
QWB 842	<b>KV 228</b>
QWB 843	<b>KV 100</b>
QWB 846	<b>KF 261</b>
QWB 846	<b>KF 264</b>
QWB 847	<b>KF 259</b>

QH	Fersa
QWB 850	<b>KV 100</b>
QWB 853	<b>KF 166</b>
QWB 854	<b>KF 270</b>
QWB 855	<b>KF 165</b>
QWB 855	<b>KF 168</b>
QWB 857	<b>KV 215</b>
QWB 859	<b>KF 116</b>
QWB 860	<b>KV 220</b>
QWB 861	<b>KV 222</b>
QWB 862	<b>KV 221</b>
QWB 863	<b>KA 085</b>
QWB 865	<b>KB 263</b>
QWB 868	<b>KV 267</b>
QWB 870	<b>KB 008</b>
QWB 872	<b>KV 258</b>
QWB 876	<b>KV 235</b>
QWB 877	<b>KV 202</b>
QWB 878	<b>KF 138</b>
QWB 879	<b>KV 252</b>
QWB 880	<b>KF 183</b>
QWB 889	<b>KF 225</b>
QWB 890	<b>KF 227</b>
QWB 891	<b>KV 226</b>
QWB 896	<b>KC 223</b>
QWB 899	<b>KF 316</b>
QWB 900	<b>KF 316</b>
QWB 906	<b>KF 104</b>
QWB 907	<b>KB 047</b>
QWB 908	<b>KV 219</b>
QWB 915	<b>KA 061</b>
QWB 919	<b>KF 225</b>
QWB 920	<b>KF 227</b>
QWB 921	<b>KV 232</b>
QWB 926	<b>KV 228</b>
QWB 928	<b>KF 130</b>
QWB 931	<b>KF 129</b>
QWB 935	<b>KF 137</b>
QWB 939	<b>KV 267</b>
QWB 941	<b>KF 321</b>
QWB 942	<b>KA 269</b>
QWB 944	<b>KF 094</b>
QWB 945	<b>KF 098</b>
QWB 946	<b>KF 298</b>
QWB 947	<b>KV 144</b>
QWB 951	<b>KV 244</b>
QWB 952	<b>KV 243</b>
QWB 956	<b>KF 128</b>
QWB 957	<b>KD 121</b>
QWB 958	<b>KD 121</b>
QWB 959	<b>KF 301</b>
QWB 961	<b>KF 128</b>
QWB 964	<b>KV 237</b>
QWB 965	<b>KV 229</b>
QWB 971	<b>KV 177</b>
QWB 971	<b>KV 178</b>
QWB 972	<b>KC 224</b>

## QH - Fersa

QH	Fersa
QWB 974	<b>KF 113</b>
QWB 978	<b>KV 271</b>
QWB 981	<b>KD 119</b>
QWB 982	<b>KD 121</b>
QWB 984	<b>KV 120</b>
QWB 988	<b>KV 122</b>
QWB 994	<b>KF 101</b>
QWB 995	<b>KA 080</b>
QWB 996	<b>KA 013</b>
QWB 997	<b>KF 233</b>
QWB 999	<b>KA 022</b>
QWB 1000	<b>KF 240</b>
QWB 1001	<b>KV 236</b>
QWB 1002	<b>KF 304</b>
QWB 1003	<b>KF 102</b>
QWB 1005	<b>KA 272</b>
QWB 1039	<b>KV 245</b>
QWB 1039	<b>KV 271</b>
QWB 1049	<b>KV 114</b>
QWB 1055	<b>KV 097</b>
QWB 1057	<b>KF 127</b>
QWB 1069	<b>KB 345</b>
QWB 1070	<b>KA 189</b>
QWB 1076	<b>KV 336</b>
QWB 1079	<b>KV 231</b>
QWB 1081	<b>KV 230</b>
QWB 1082	<b>KA 021</b>
QWB 1083	<b>KF 312</b>
QWB 1084	<b>KF 195</b>
QWB 1085	<b>KB 278</b>
QWB 1087	<b>KB 048</b>
QWB 1088	<b>KB 193</b>
QWB 1089	<b>KF 184</b>
QWB 1090	<b>KV 157</b>
QWB 1095	<b>KV 097</b>
QWB 1096	<b>KF 277</b>
QWB 1097	<b>KF 283</b>
QWB 1098	<b>KF 288</b>
QWB 1101	<b>KV 251</b>
QWB 1102	<b>KF 346</b>
QWB 1104	<b>KF 277</b>
QWB 1105	<b>KF 195</b>
QWB 1112	<b>KV 196</b>
QWB 1113	<b>KV 198</b>
QWB 1114	<b>KV 199</b>
QWB 1115	<b>KV 235</b>
QWB 1115	<b>KV 279</b>
QWB 1117	<b>KV 247</b>
QWB 1118	<b>KF 264</b>
QWB 1124	<b>KF 099</b>
QWB 1126	<b>KF 201</b>
QWB 1127	<b>KF 282</b>
QWB 1128	<b>KB 191</b>
QWB 1131	<b>KV 246</b>
QWB 1133	<b>KV 157</b>
QWB 1137	<b>KV 276</b>

QH	Fersa
QWB 113C	<b>KA 014</b>
QWB 1146	<b>KF 241</b>
QWB 1150	<b>KF 145</b>
QWB 1152	<b>KV 275</b>
QWB 1154	<b>KF 308</b>
QWB 1155	<b>KA 248</b>
QWB 1159	<b>KV 287</b>
QWB 115C	<b>KA 014</b>
QWB 115C	<b>KA 017</b>
QWB 1160	<b>KV 286</b>
QWB 1182	<b>KV 221</b>
QWB 1183	<b>KV 220</b>
QWB 1194	<b>KF 274</b>
QWB 1195	<b>KF 280</b>
QWB 1196	<b>KA 273</b>
QWB 1197	<b>KA 033</b>
QWB 1198	<b>KA 032</b>
QWB 1199	<b>KA 032</b>
QWB 1200	<b>KV 238</b>
QWB 1201	<b>KV 239</b>
QWB 1202	<b>KV 234</b>
QWB 1211	<b>KF 292</b>
QWB 1212	<b>KB 338</b>
QWB 1221	<b>KF 346</b>
QWB 1223	<b>KF 303</b>
QWB 1225	<b>KB 293</b>
QWB 1226	<b>KF 354</b>
QWB 1228	<b>KV 290</b>
QWB 1230	<b>KV 251</b>
QWB 1231	<b>KF 302</b>
QWB 1232	<b>KF 302</b>
QWB 1233	<b>KV 242</b>
QWB 1234	<b>KV 178</b>
QWB 1236	<b>KV 328</b>
QWB 1240	<b>KV 234</b>
QWB 1241	<b>KV 249</b>
QWB 1244	<b>KV 238</b>
QWB 1249	<b>KF 312</b>
QWB 1251	<b>KF 340</b>
QWB 1252	<b>KF 315</b>
QWB 1253	<b>KB 339</b>
QWB 1254	<b>KF 351</b>
QWB 1256	<b>KB 350</b>
QWB 1257	<b>KV 284</b>
QWB 1258	<b>KV 291</b>
QWB 1259	<b>KV 325</b>
QWB 1260	<b>KV 326</b>
QWB 1261	<b>KF 329</b>
QWB 1265	<b>KF 289</b>
QWB 1271	<b>KV 236</b>
QWB 1272	<b>KV 250</b>
QWB 1273	<b>KV 294</b>
QWB 1274	<b>KB 078</b>
QWB 1276	<b>KV 305</b>
QWB 1284	<b>KF 176</b>
QWB 1284	<b>KV 177</b>

QH	Fersa
QWB 1291	<b>KV 353</b>
QWB 1299	<b>KV 232</b>
QWB 1303	<b>KB 191</b>

## SKF - Fersa

SKF	Fersa
VKBA 310	<b>KV 204</b>
VKBA 501	<b>KA 059</b>
VKBA 502	<b>KA 068</b>
VKBA 504	<b>KA 014</b>
VKBA 505	<b>KA 017</b>
VKBA 506	<b>KA 040</b>
VKBA 513	<b>KA 002</b>
VKBA 517	<b>KA 025</b>
VKBA 523	<b>KA 083</b>
VKBA 525	<b>KA 064</b>
VKBA 526	<b>KA 039</b>
VKBA 527	<b>KA 066</b>
VKBA 528	<b>KA 016</b>
VKBA 528	<b>KA 075</b>
VKBA 529	<b>KA 006</b>
VKBA 529	<b>KA 069</b>
VKBA 532	<b>KA 001</b>
VKBA 534	<b>KA 065</b>
VKBA 540	<b>KA 041</b>
VKBA 542	<b>KA 005</b>
VKBA 543	<b>KA 074</b>
VKBA 546	<b>KA 089</b>
VKBA 547	<b>KA 088</b>
VKBA 548	<b>KA 043</b>
VKBA 559	<b>KF 161</b>
VKBA 562	<b>KA 210</b>
VKBA 564	<b>KA 042</b>
VKBA 571	<b>KA 211</b>
VKBA 575	<b>KF 095</b>
VKBA 575	<b>KF 185</b>
VKBA 577	<b>KF 180</b>
VKBA 593	<b>KF 179</b>
VKBA 596	<b>KA 027</b>
VKBA 607	<b>KC 253</b>
VKBA 614	<b>KA 026</b>
VKBA 618	<b>KF 139</b>
VKBA 622	<b>KF 140</b>
VKBA 625	<b>KV 162</b>
VKBA 629	<b>KC 146</b>
VKBA 636	<b>KC 148</b>
VKBA 638	<b>KF 150</b>
VKBA 639	<b>KC 147</b>
VKBA 652	<b>KA 044</b>
VKBA 663	<b>KF 133</b>
VKBA 673	<b>KC 132</b>
VKBA 675	<b>KC 174</b>
VKBA 684	<b>KA 036</b>
VKBA 685	<b>KF 160</b>
VKBA 686	<b>KA 015</b>
VKBA 687	<b>KA 019</b>
VKBA 708	<b>KA 349</b>
VKBA 709	<b>KD 348</b>
VKBA 713	<b>KA 086</b>
VKBA 718	<b>KA 004</b>

SKF	Fersa
VKBA 723	<b>KC 149</b>
VKBA 728	<b>KA 073</b>
VKBA 729	<b>KF 141</b>
VKBA 733	<b>KA 212</b>
VKBA 734	<b>KV 163</b>
VKBA 736	<b>KF 134</b>
VKBA 738	<b>KF 172</b>
VKBA 740	<b>KA 018</b>
VKBA 741	<b>KA 081</b>
VKBA 743	<b>KV 144</b>
VKBA 749	<b>KA 254</b>
VKBA 752	<b>KA 077</b>
VKBA 756	<b>KA 030</b>
VKBA 757	<b>KF 124</b>
VKBA 801	<b>KA 072</b>
VKBA 802	<b>KA 071</b>
VKBA 813	<b>KB 011</b>
VKBA 814	<b>KB 012</b>
VKBA 826	<b>KA 070</b>
VKBA 829	<b>KA 255</b>
VKBA 830	<b>KA 091</b>
VKBA 837	<b>KA 051</b>
VKBA 838	<b>KA 050</b>
VKBA 844	<b>KA 009</b>
VKBA 845	<b>KA 010</b>
VKBA 869	<b>KB 045</b>
VKBA 882	<b>KF 142</b>
VKBA 890	<b>KV 103</b>
VKBA 897	<b>KA 076</b>
VKBA 898	<b>KA 082</b>
VKBA 906	<b>KF 181</b>
VKBA 908	<b>KF 314</b>
VKBA 909	<b>KF 153</b>
VKBA 910	<b>KC 256</b>
VKBA 915	<b>KF 143</b>
VKBA 918	<b>KA 347</b>
VKBA 919	<b>KA 257</b>
VKBA 922	<b>KD 117</b>
VKBA 925	<b>KA 056</b>
VKBA 926	<b>KA 055</b>
VKBA 927	<b>KA 213</b>
VKBA 929	<b>KA 057</b>
VKBA 938	<b>KV 105</b>
VKBA 941	<b>KA 028</b>
VKBA 944	<b>KA 038</b>
VKBA 949	<b>KA 214</b>
VKBA 958	<b>KD 118</b>
VKBA 959	<b>KA 084</b>
VKBA 961	<b>KB 008</b>
VKBA 963	<b>KF 093</b>
VKBA 964	<b>KF 092</b>
VKBA 966	<b>KV 152</b>
VKBA 967	<b>KV 154</b>
VKBA 968	<b>KV 258</b>

SKF	Fersa
VKBA 969	<b>KB 090</b>
VKBA 973	<b>KC 205</b>
VKBA 975	<b>KB 046</b>
VKBA 976	<b>KB 047</b>
VKBA 977	<b>KA 049</b>
VKBA 1301	<b>KV 135</b>
VKBA 1310	<b>KA 034</b>
VKBA 1315	<b>KF 175</b>
VKBA 1317	<b>KF 104</b>
VKBA 1318	<b>KF 107</b>
VKBA 1320	<b>KF 106</b>
VKBA 1324	<b>KA 024</b>
VKBA 1326	<b>KF 136</b>
VKBA 1327	<b>KF 111</b>
VKBA 1328	<b>KF 112</b>
VKBA 1331	<b>KV 215</b>
VKBA 1333	<b>KA 021</b>
VKBA 1337	<b>KA 029</b>
VKBA 1340	<b>KF 259</b>
VKBA 1344	<b>KF 173</b>
VKBA 1346	<b>KF 352</b>
VKBA 1347	<b>KB 125</b>
VKBA 1355	<b>KF 096</b>
VKBA 1356	<b>KF 098</b>
VKBA 1356	<b>KF 306</b>
VKBA 1356	<b>KF 307</b>
VKBA 1358	<b>KF 182</b>
VKBA 1358	<b>KF 216</b>
VKBA 1362	<b>KF 129</b>
VKBA 1363	<b>KB 217</b>
VKBA 1366	<b>KA 022</b>
VKBA 1367	<b>KA 187</b>
VKBA 1369	<b>KA 023</b>
VKBA 1371	<b>KC 188</b>
VKBA 1374	<b>KF 099</b>
VKBA 1375	<b>KV 260</b>
VKBA 1377	<b>KF 320</b>
VKBA 1379	<b>KV 100</b>
VKBA 1385	<b>KA 169</b>
VKBA 1387	<b>KA 171</b>
VKBA 1393	<b>KA 170</b>
VKBA 1396	<b>KA 087</b>
VKBA 1403	<b>KF 261</b>
VKBA 1406	<b>KV 156</b>
VKBA 1410	<b>KF 203</b>
VKBA 1430	<b>KA 054</b>
VKBA 1431	<b>KA 020</b>
VKBA 1432	<b>KF 115</b>
VKBA 1432	<b>KF 327</b>
VKBA 1436	<b>KV 177</b>
VKBA 1437	<b>KV 178</b>
VKBA 1438	<b>KF 165</b>
VKBA 1439	<b>KF 166</b>
VKBA 1440	<b>KV 164</b>

## SKF - Fersa

SKF	Fersa
VKBA 1441	<b>KV 218</b>
VKBA 1444	<b>KA 079</b>
VKBA 1446	<b>KA 058</b>
VKBA 1447	<b>KF 094</b>
VKBA 1458	<b>KV 108</b>
VKBA 1459	<b>KF 109</b>
VKBA 1460	<b>KF 110</b>
VKBA 1462	<b>KA 200</b>
VKBA 1465	<b>KA 085</b>
VKBA 1467	<b>KB 263</b>
VKBA 1470	<b>KA 126</b>
VKBA 1475	<b>KV 219</b>
VKBA 1480	<b>KF 116</b>
VKBA 1481	<b>KV 220</b>
VKBA 1482	<b>KV 221</b>
VKBA 1484	<b>KV 222</b>
VKBA 1487	<b>KA 003</b>
VKBA 1488	<b>KF 264</b>
VKBA 1491	<b>KF 183</b>
VKBA 1494	<b>KV 157</b>
VKBA 1495	<b>KF 176</b>
VKBA 1498	<b>KA 189</b>
VKBA 1915	<b>KA 190</b>
VKBA 1930	<b>KC 223</b>
VKBA 1931	<b>KC 224</b>
VKBA 1933	<b>KF 301</b>
VKBA 1948	<b>KF 225</b>
VKBA 1949	<b>KV 226</b>
VKBA 1950	<b>KF 227</b>
VKBA 1953	<b>KA 131</b>
VKBA 1956	<b>KA 186</b>
VKBA 1965	<b>KA 067</b>
VKBA 1970	<b>KD 121</b>
VKBA 1971	<b>KC 265</b>
VKBA 1973	<b>KF 317</b>
VKBA 1978	<b>KA 061</b>
VKBA 1999	<b>KF 128</b>
VKBA 3201	<b>KF 130</b>
VKBA 3206	<b>KA 266</b>
VKBA 3216	<b>KF 310</b>
VKBA 3218	<b>KV 228</b>
VKBA 3219	<b>KB 062</b>
VKBA 3225	<b>KV 267</b>
VKBA 3237	<b>KF 316</b>
VKBA 3245	<b>KF 304</b>
VKBA 3246	<b>KF 102</b>
VKBA 3250	<b>KV 229</b>
VKBA 3255	<b>KA 007</b>
VKBA 3266	<b>KV 230</b>
VKBA 3267	<b>KV 231</b>
VKBA 3298	<b>KV 232</b>
VKBA 3305	<b>KV 120</b>
VKBA 3309	<b>KD 119</b>
VKBA 3311	<b>KF 318</b>

SKF	Fersa
VKBA 3319	<b>KA 035</b>
VKBA 3321	<b>KA 268</b>
VKBA 3326	<b>KV 122</b>
VKBA 3327	<b>KV 123</b>
VKBA 3403	<b>KF 137</b>
VKBA 3404	<b>KA 033</b>
VKBA 3405	<b>KA 032</b>
VKBA 3406	<b>KF 233</b>
VKBA 3407	<b>KA 269</b>
VKBA 3408	<b>KF 158</b>
VKBA 3409	<b>KV 202</b>
VKBA 3410	<b>KF 138</b>
VKBA 3413	<b>KF 270</b>
VKBA 3414	<b>KF 168</b>
VKBA 3415	<b>KV 271</b>
VKBA 3416	<b>KF 167</b>
VKBA 3418	<b>KV 234</b>
VKBA 3420	<b>KA 052</b>
VKBA 3421	<b>KA 053</b>
VKBA 3422	<b>KV 235</b>
VKBA 3423	<b>KF 113</b>
VKBA 3424	<b>KV 236</b>
VKBA 3427	<b>KF 308</b>
VKBA 3428	<b>KA 272</b>
VKBA 3429	<b>KA 013</b>
VKBA 3430	<b>KA 080</b>
VKBA 3434	<b>KA 273</b>
VKBA 3441	<b>KF 159</b>
VKBA 3442	<b>KV 237</b>
VKBA 3444	<b>KV 238</b>
VKBA 3445	<b>KV 239</b>
VKBA 3447	<b>KF 274</b>
VKBA 3449	<b>KF 240</b>
VKBA 3450	<b>KF 241</b>
VKBA 3455	<b>KF 184</b>
VKBA 3456	<b>KV 097</b>
VKBA 3456	<b>KV 194</b>
VKBA 3458	<b>KV 242</b>
VKBA 3461	<b>KF 101</b>
VKBA 3468	<b>KV 243</b>
VKBA 3469	<b>KV 244</b>
VKBA 3477	<b>KV 114</b>
VKBA 3480	<b>KV 275</b>
VKBA 3486	<b>KF 127</b>
VKBA 3488	<b>KV 245</b>
VKBA 3489	<b>KV 276</b>
VKBA 3490	<b>KF 313</b>
VKBA 3491	<b>KV 246</b>
VKBA 3492	<b>KF 277</b>
VKBA 3495	<b>KF 195</b>
VKBA 3496	<b>KB 048</b>
VKBA 3496	<b>KB 192</b>
VKBA 3496	<b>KB 262</b>
VKBA 3499	<b>KF 303</b>

SKF	Fersa
VKBA 3500	<b>KB 278</b>
VKBA 3504	<b>KF 312</b>
VKBA 3510	<b>KV 196</b>
VKBA 3511	<b>KV 198</b>
VKBA 3512	<b>KV 247</b>
VKBA 3513	<b>KV 199</b>
VKBA 3514	<b>KV 279</b>
VKBA 3519	<b>KA 248</b>
VKBA 3521	<b>KB 345</b>
VKBA 3522	<b>KF 280</b>
VKBA 3525	<b>KB 193</b>
VKBA 3526	<b>KV 249</b>
VKBA 3528	<b>KF 281</b>
VKBA 3530	<b>KF 201</b>
VKBA 3531	<b>KF 282</b>
VKBA 3532	<b>KB 191</b>
VKBA 3536	<b>KV 250</b>
VKBA 3538	<b>KF 346</b>
VKBA 3539	<b>KF 283</b>
VKBA 3540	<b>KV 251</b>
VKBA 3546	<b>KV 305</b>
VKBA 3548	<b>KV 284</b>
VKBA 3550	<b>KV 285</b>
VKBA 3554	<b>KF 145</b>
VKBA 3555	<b>KV 252</b>
VKBA 3556	<b>KB 078</b>
VKBA 3567	<b>KV 286</b>
VKBA 3569	<b>KV 287</b>
VKBA 3571	<b>KF 342</b>
VKBA 3572	<b>KF 341</b>
VKBA 3575	<b>KF 329</b>
VKBA 3576	<b>KV 328</b>
VKBA 3577	<b>KF 288</b>
VKBA 3584	<b>KF 289</b>
VKBA 3585	<b>KV 290</b>
VKBA 3588	<b>KV 291</b>
VKBA 3589	<b>KV 325</b>
VKBA 3590	<b>KV 326</b>
VKBA 3596	<b>KF 155</b>
VKBA 3600	<b>KF 292</b>
VKBA 3601	<b>KB 338</b>
VKBA 3602	<b>KV 337</b>
VKBA 3613	<b>KB 293</b>
VKBA 3614	<b>KB 344</b>
VKBA 3616	<b>KF 315</b>
VKBA 3617	<b>KB 339</b>
VKBA 3618	<b>KF 340</b>
VKBA 3620	<b>KV 343</b>
VKBA 3624	<b>KV 336</b>
VKBA 3628	<b>KB 300</b>
VKBA 3635	<b>KV 294</b>
VKBA 3637	<b>KF 351</b>
VKBA 3639	<b>KB 350</b>
VKBA 3640	<b>KB 295</b>



## SKF - Fersa

SKF	Fersa
VKBA 3641	<b>KB 296</b>
VKBA 3647	<b>KF 302</b>
VKBA 3648	<b>KF 334</b>
VKBA 3650	<b>KV 333</b>
VKBA 3651	<b>KV 332</b>
VKBA 3652	<b>KV 330</b>
VKBA 3653	<b>KV 331</b>
VKBA 3654	<b>KV 323</b>
VKBA 3655	<b>KV 324</b>
VKBA 3657	<b>KF 354</b>
VKBA 3660	<b>KV 322</b>
VKBA 3667	<b>KV 297</b>
VKBA 3703	<b>KF 321</b>
VKBA 3729	<b>KF 298</b>
VKBA 3730	<b>KF 197</b>
VKBA 3907	<b>KF 299</b>
VKBA 3930	<b>KV 353</b>
VKBA 3945	<b>KF 309</b>
VKBA 6507	<b>KV 335</b>
VKBA 6643	<b>KF 319</b>

## SNR - Fersa

SNR	Fersa
R 140.01	<b>KB 344</b>
R 140.02	<b>KB 011</b>
R 140.03	<b>KB 012</b>
R 140.06	<b>KB 293</b>
R 140.17	<b>KB 295</b>
R 140.23	<b>KA 255</b>
R 140.25	<b>KA 091</b>
R 140.26	<b>KA 070</b>
R 140.34	<b>KA 023</b>
R 140.38	<b>KB 296</b>
R 140.42	<b>KA 009</b>
R 140.43	<b>KA 010</b>
R 140.52	<b>KD 117</b>
R 140.56	<b>KA 049</b>
R 140.58	<b>KA 169</b>
R 140.60	<b>KA 171</b>
R 140.65	<b>KA 170</b>
R 140.70	<b>KD 118</b>
R 140.72	<b>KA 033</b>
R 140.73	<b>KA 032</b>
R 140.76	<b>KA 273</b>
R 140.77	<b>KA 079</b>
R 140.79	<b>KA 058</b>
R 140.80	<b>KA 084</b>
R 140.81	<b>KA 269</b>
R 140.83	<b>KA 200</b>
R 140.85	<b>KB 263</b>
R 140.87	<b>KA 085</b>
R 140.91	<b>KA 266</b>
R 140.94	<b>KA 272</b>
R 140.95	<b>KA 013</b>
R 140.96	<b>KA 080</b>
R 140.97	<b>KF 233</b>
R 150.12	<b>KF 107</b>
R 150.15	<b>KV 103</b>
R 150.16	<b>KF 104</b>
R 150.17	<b>KV 105</b>
R 150.19	<b>KF 106</b>
R 150.22	<b>KV 108</b>
R 150.22	<b>KV 297</b>
R 150.23	<b>KF 109</b>
R 150.24	<b>KF 110</b>
R 150.25	<b>KF 274</b>
R 150.29	<b>KV 239</b>
R 150.30	<b>KV 238</b>
R 150.31	<b>KF 303</b>
R 150.36	<b>KV 238</b>
R 151.02	<b>KA 025</b>
R 151.03	<b>KA 026</b>
R 151.05	<b>KA 027</b>
R 151.07	<b>KF 124</b>
R 151.08	<b>KA 030</b>
R 151.10	<b>KA 126</b>
R 151.11	<b>KA 087</b>
R 151.12	<b>KA 029</b>
R 151.13(S)	<b>KF 124</b>

SNR	Fersa
R 151.14	<b>KA 028</b>
R 151.15	<b>KB 125</b>
R 151.16	<b>KB 125</b>
R 151.18	<b>KA 189</b>
R 151.19	<b>KF 124</b>
R 151.24	<b>KA 189</b>
R 151.25	<b>KB 300</b>
R 151.26	<b>KF 280</b>
R 151.27	<b>KF 127</b>
R 151.28	<b>KB 300</b>
R 151.29	<b>KF 124</b>
R 151.30	<b>KB 300</b>
R 151.32	<b>KB 345</b>
R 151.34	<b>KB 300</b>
R 151.39	<b>KB 300</b>
R 152.02	<b>KA 083</b>
R 152.08	<b>KA 017</b>
R 152.12	<b>KA 014</b>
R 152.16	<b>KA 015</b>
R 152.17	<b>KA 016</b>
R 152.19	<b>KA 019</b>
R 152.20	<b>KA 074</b>
R 152.21	<b>KA 018</b>
R 152.23	<b>KF 329</b>
R 152.24	<b>KV 328</b>
R 152.28	<b>KA 076</b>
R 152.29	<b>KA 081</b>
R 152.32	<b>KA 347</b>
R 152.33	<b>KA 257</b>
R 152.34	<b>KA 082</b>
R 152.36	<b>KA 020</b>
R 152.37	<b>KA 021</b>
R 152.37S	<b>KA 021</b>
R 152.38	<b>KA 021</b>
R 152.39	<b>KF 115</b>
R 152.42	<b>KF 116</b>
R 152.43	<b>KV 220</b>
R 152.44	<b>KV 221</b>
R 152.45	<b>KV 222</b>
R 152.54	<b>KF 201</b>
R 152.55	<b>KF 282</b>
R 152.56	<b>KB 191</b>
R 152.58	<b>KV 325</b>
R 152.59	<b>KV 326</b>
R 152.60	<b>KV 291</b>
R 152.62	<b>KV 322</b>
R 152.66	<b>KV 324</b>
R 152.67	<b>KV 323</b>
R 153.03	<b>KA 040</b>
R 153.07	<b>KA 007</b>
R 153.07	<b>KA 038</b>
R 153.14	<b>KF 133</b>
R 153.15	<b>KF 134</b>
R 153.16	<b>KA 039</b>
R 153.18	<b>KV 135</b>
R 153.19	<b>KV 135</b>

## SNR - Fersa

SNR	Fersa
R 153.20	<b>KF 136</b>
R 153.22	<b>KV 235</b>
R 153.23	<b>KV 202</b>
R 153.25	<b>KF 137</b>
R 153.26	<b>KF 138</b>
R 153.27	<b>KV 252</b>
R 153.30	<b>KV 247</b>
R 153.31	<b>KV 196</b>
R 153.32	<b>KV 198</b>
R 153.33	<b>KV 199</b>
R 153.34	<b>KV 279</b>
R 153.35	<b>KF 342</b>
R 153.36	<b>KF 341</b>
R 153.37	<b>KB 338</b>
R 153.38	<b>KV 337</b>
R 153.39	<b>KF 292</b>
R 153.40	<b>KV 343</b>
R 153.41	<b>KV 336</b>
R 153.43	<b>KV 335</b>
R 153.47	<b>KV 333</b>
R 153.48	<b>KV 332</b>
R 153.49	<b>KV 331</b>
R 153.50	<b>KV 330</b>
R 154.01	<b>KF 184</b>
R 154.08	<b>KC 256</b>
R 154.12	<b>KF 180</b>
R 154.13	<b>KA 006</b>
R 154.14	<b>KF 179</b>
R 154.15	<b>KF 095</b>
R 154.17	<b>KA 071</b>
R 154.18	<b>KA 072</b>
R 154.23	<b>KF 181</b>
R 154.26	<b>KF 095</b>
R 154.28	<b>KF 182</b>
R 154.32	<b>KF 233</b>
R 154.33	<b>KF 233</b>
R 154.34	<b>KF 183</b>
R 154.35	<b>KF 183</b>
R 154.38	<b>KF 182</b>
R 154.40	<b>KF 181</b>
R 154.41	<b>KF 240</b>
R 154.42	<b>KF 241</b>
R 154.43	<b>KF 098</b>
R 154.44	<b>KV 276</b>
R 154.45	<b>KV 284</b>
R 154.49	<b>KF 159</b>
R 154.50	<b>KA 248</b>
R 154.52	<b>KV 285</b>
R 155.00	<b>KC 146</b>
R 155.01	<b>KC 147</b>
R 155.03	<b>KA 043</b>
R 155.05	<b>KA 042</b>
R 155.06	<b>KA 044</b>
R 155.08	<b>KC 149</b>
R 155.09	<b>KF 314</b>
R 155.09	<b>KF 153</b>

SNR	Fersa
R 155.10	<b>KC 148</b>
R 155.11	<b>KV 152</b>
R 155.13	<b>KB 045</b>
R 155.14	<b>KF 314</b>
R 155.14	<b>KF 153</b>
R 155.15	<b>KV 154</b>
R 155.16	<b>KF 158</b>
R 155.16	<b>KF 155</b>
R 155.17	<b>KB 046</b>
R 155.18	<b>KV 258</b>
R 155.19	<b>KB 090</b>
R 155.21	<b>KF 150</b>
R 155.24	<b>KV 156</b>
R 155.26	<b>KV 157</b>
R 155.27	<b>KB 047</b>
R 155.32	<b>KB 048</b>
R 155.39	<b>KV 154</b>
R 155.39	<b>KV 258</b>
R 155.40	<b>KV 154</b>
R 155.44	<b>KF 195</b>
R 155.46	<b>KV 244</b>
R 155.47	<b>KV 243</b>
R 155.52	<b>KF 312</b>
R 155.56	<b>KV 246</b>
R 155.58	<b>KB 047</b>
R 155.61	<b>KF 277</b>
R 155.63	<b>KB 193</b>
R 155.64	<b>KB 278</b>
R 155.69	<b>KF 340</b>
R 155.70	<b>KB 339</b>
R 155.71	<b>KF 315</b>
R 155.74	<b>KF 334</b>
R 155.75	<b>KF 351</b>
R 155.77	<b>KB 350</b>
R 156.04	<b>KF 172</b>
R 157.05	<b>KA 005</b>
R 157.08	<b>KF 096</b>
R 157.09	<b>KF 098</b>
R 157.11	<b>KF 098</b>
R 157.12	<b>KA 005</b>
R 157.13	<b>KF 096</b>
R 157.14	<b>KF 098</b>
R 157.16	<b>KF 308</b>
R 157.17	<b>KF 308</b>
R 157.18	<b>KF 098</b>
R 157.19	<b>KF 096</b>
R 157.20	<b>KV 097</b>
R 157.21	<b>KF 098</b>
R 157.22	<b>KF 184</b>
R 157.23	<b>KF 096</b>
R 157.24	<b>KF 098</b>
R 157.25	<b>KF 096</b>
R 157.26	<b>KV 250</b>
R 157.31	<b>KV 286</b>
R 157.32	<b>KV 287</b>
R 158.00	<b>KA 055</b>

SNR	Fersa
R 158.01	<b>KA 056</b>
R 158.02	<b>KA 213</b>
R 158.04	<b>KA 210</b>
R 158.07	<b>KF 161</b>
R 158.08	<b>KA 057</b>
R 158.10	<b>KV 162</b>
R 158.11	<b>KC 253</b>
R 158.12	<b>KF 160</b>
R 158.13	<b>KV 163</b>
R 158.14	<b>KV 204</b>
R 158.18	<b>KF 261</b>
R 158.21	<b>KV 218</b>
R 158.22	<b>KV 164</b>
R 158.23	<b>KV 164</b>
R 158.28	<b>KF 160</b>
R 158.31	<b>KF 165</b>
R 158.32	<b>KF 166</b>
R 158.34	<b>KF 270</b>
R 158.35	<b>KF 168</b>
R 158.36	<b>KF 166</b>
R 158.37	<b>KF 167</b>
R 158.39	<b>KV 237</b>
R 158.41	<b>KF 281</b>
R 158.42	<b>KF 288</b>
R 158.43	<b>KF 283</b>
R 158.44	<b>KF 346</b>
R 158.46	<b>KV 251</b>
R 159.03	<b>KF 140</b>
R 159.04	<b>KA 088</b>
R 159.07	<b>KF 139</b>
R 159.08	<b>KA 041</b>
R 159.11	<b>KA 089</b>
R 159.12	<b>KA 073</b>
R 159.13	<b>KF 141</b>
R 159.14	<b>KF 142</b>
R 159.15	<b>KV 144</b>
R 159.17	<b>KF 145</b>
R 159.19	<b>KB 008</b>
R 159.22	<b>KV 215</b>
R 159.27	<b>KA 089</b>
R 159.29	<b>KV 219</b>
R 159.31	<b>KF 113</b>
R 159.32	<b>KV 236</b>
R 159.38	<b>KB 078</b>
R 159.40	<b>KV 305</b>
R 159.42	<b>KV 290</b>
R 159.44	<b>KF 289</b>
R 159.46	<b>KV 294</b>
R 159.99	<b>KV 236</b>
R 160.02	<b>KA 001</b>
R 160.04	<b>KA 002</b>
R 160.06	<b>KA 003</b>
R 160.13	<b>KF 092</b>
R 160.14	<b>KF 093</b>
R 160.15	<b>KF 264</b>
R 160.18	<b>KF 094</b>

## SNR - Fersa

SNR	Fersa
R 160.19	KA 004
R 160.20	KF 264
R 160.36	KA 002
R 160.38	KA 003
R 160.40	KF 093
R 160.44	KA 004
R 161.09	KA 254
R 161.23	KF 101
R 163.00	KA 068
R 163.19	KA 068
R 164.16	KV 252
R 165.03	KA 211
R 165.05	KA 212
R 165.10	KV 177
R 165.11	KF 175
R 165.15	KV 178
R 165.16	KF 176
R 165.17	KV 271
R 165.20	KV 234
R 165.22	KV 242
R 165.23	KV 271
R 165.23	KV 245
R 165.24	KF 302
R 165.26	KV 249
R 166.03	KF 354
R 166.13	KF 143
R 166.14	KF 111
R 166.15	KF 112
R 166.22	KV 219
R 166.24	KV 114
R 166.26	KV 275
R 166.28	KF 313
R 168.04	KC 132
R 168.09	KA 036
R 168.10	KA 077
R 168.15	KA 034
R 168.18	KF 129
R 168.19	KB 217
R 168.23	KF 129
R 168.24	KV 267
R 168.26	KF 128
R 168.30	KF 130
R 168.35	KF 128
R 168.40	KF 321
R 168.41	KA 131
R 168.42	KF 318
R 168.50	KA 035
R 168.52	KA 268
R 169.01	KA 065
R 169.02	KA 066
R 169.02	KA 067
R 169.04	KC 174
R 169.10	KF 173
R 169.14	KF 352
R 169.17	KA 067
R 169.24	KF 310

SNR	Fersa
R 169.30	KV 353
R 169.36	KF 316
R 169.37	KF 197
R 169.38	KF 298
R 169.50	KF 259
R 169.60	KF 309
R 170.09	KA 214
R 170.22	KF 227
R 170.23	KV 226
R 170.24	KV 232
R 170.32	KF 225
R 172.00	KC 205
R 172.01	KA 024
R 173.00	KA 086
R 173.05	KC 188
R 173.06	KA 190
R 173.07	KA 186
R 173.09	KA 187
R 173.10	KF 317
R 173.14	KD 121
R 173.15	KA 022
R 173.16	KV 228
R 173.17	KV 122
R 173.18	KV 123
R 173.22	KD 119
R 173.23	KV 120
R 174.12	KF 099
R 174.13	KF 320
R 174.16	KV 260
R 174.19	KV 100
R 174.23	KV 100
R 174.25	KF 304
R 174.28	KV 229
R 174.34	KF 102
R 174.35	KV 100
R 177.02	KA 061
R 177.06	KF 301
R 177.08	KC 224
R 177.09	KC 223
R 177.10	KC 224
R 177.11	KC 265
R 177.12	KB 062
R 178.00	KA 349
R 178.01	KD 348
R 178.03	KA 054
R 180.00	KA 050
R 180.01	KA 052
R 180.02	KA 053
R 182.60	KF 203
R 184.02	KV 230
R 184.03	KV 231
R 184.05	KF 299

## TIMKEN - Fersa

TIMKEN	Fersa
K 82370	KF 318
K 89914	KF 153
K 80102	KA 001
K 80103	KA 002
K 80104	KA 003
K 80107	KA 077
K 80108	KF 092
K 80113	KA 004
K 80115	KF 093
K 80116	KF 094
K 80119	KF 264
K 80122	KV 219
K 80123	KF 346
K 80124	KF 283
K 80125	KV 236
K 80125	KV 251
K 80153	KB 012
K 80202	KA 005
K 80203	KA 006
K 80203	KA 069
K 80206	KF 307
K 80207	KF 096
K 80208	KF 308
K 80212	KF 184
K 80213	KV 097
K 80213	KV 194
K 80214	KF 098
K 80214	KF 306
K 80215	KA 248
K 80217	KV 250
K 80309	KF 320
K 80310	KF 099
K 80312	KV 100
K 80313	KV 260
K 80323	KF 101
K 80326	KV 229
K 80328	KF 304
K 80329	KF 102
K 80334	KA 254
K 80402	KF 134
K 80403	KA 007
K 80506	KV 103
K 80507	KF 104
K 80511	KF 106
K 80514	KF 107
K 80515	KV 105
K 80516	KV 108
K 80517	KF 109
K 80518	KF 110
K 80520	KV 238
K 80521	KV 239
K 80708	KA 073
K 80712	KB 008
K 80718	KF 111
K 80719	KF 112
K 80723	KV 215

## TIMKEN - Fersa

TIMKEN	Fersa
K 80724	<b>KF 113</b>
K 80732	<b>KV 275</b>
K 80734	<b>KF 313</b>
K 80737	<b>KB 078</b>
K 80750	<b>KA 009</b>
K 80751	<b>KA 010</b>
K 80752	<b>KB 011</b>
K 80754	<b>KA 079</b>
K 80755	<b>KA 272</b>
K 80756	<b>KA 013</b>
K 80757	<b>KA 080</b>
K 81101	<b>KA 074</b>
K 81102	<b>KA 014</b>
K 81103	<b>KA 015</b>
K 81104	<b>KA 016</b>
K 81104	<b>KA 075</b>
K 81107	<b>KA 017</b>
K 81109	<b>KA 018</b>
K 81110	<b>KA 076</b>
K 81115	<b>KA 347</b>
K 81115	<b>KA 257</b>
K 81116	<b>KA 020</b>
K 81117	<b>KA 021</b>
K 81118	<b>KA 081</b>
K 81119	<b>KA 082</b>
K 81111	<b>KA 019</b>
K 81120	<b>KF 115</b>
K 81120	<b>KF 327</b>
K 81125	<b>KF 116</b>
K 81126	<b>KV 220</b>
K 81127	<b>KV 221</b>
K 81129	<b>KV 222</b>
K 81135	<b>KF 240</b>
K 81136	<b>KF 241</b>
K 81139	<b>KF 201</b>
K 81140	<b>KF 282</b>
K 81141	<b>KB 191</b>
K 81143	<b>KF 329</b>
K 81144	<b>KV 328</b>
K 81150	<b>KA 083</b>
K 81151	<b>KA 085</b>
K 81151	<b>KD 117</b>
K 81155	<b>KA 084</b>
K 81156	<b>KD 118</b>
K 81159	<b>KB 263</b>
K 81160	<b>KV 291</b>
K 81161	<b>KV 325</b>
K 81162	<b>KV 326</b>
K 81201	<b>KA 022</b>
K 81203	<b>KV 231</b>
K 81204	<b>KV 230</b>
K 81206	<b>KA 086</b>
K 81207	<b>KA 190</b>
K 81208	<b>KA 186</b>
K 81209	<b>KA 023</b>
K 81211	<b>KA 187</b>

TIMKEN	Fersa
K 81213	<b>KD 119</b>
K 81214	<b>KV 120</b>
K 81219	<b>KD 121</b>
K 81220	<b>KV 122</b>
K 81221	<b>KV 123</b>
K 81223	<b>KC 188</b>
K 81229	<b>KF 299</b>
K 81802	<b>KC 205</b>
K 81850	<b>KA 024</b>
K 81905	<b>KF 227</b>
K 81906	<b>KF 225</b>
K 81907	<b>KV 226</b>
K 81908	<b>KV 232</b>
K 82001	<b>KA 025</b>
K 82002	<b>KA 026</b>
K 82003	<b>KA 027</b>
K 82005	<b>KF 124</b>
K 82006	<b>KA 028</b>
K 82007	<b>KB 125</b>
K 82008	<b>KA 029</b>
K 82009	<b>KA 030</b>
K 82011	<b>KA 189</b>
K 82017	<b>KF 280</b>
K 82050	<b>KA 087</b>
K 82053	<b>KA 126</b>
K 82056	<b>KA 031</b>
K 82057	<b>KA 032</b>
K 82058	<b>KA 033</b>
K 82066	<b>KA 273</b>
K 82068	<b>KF 127</b>
K 82301	<b>KF 128</b>
K 82302	<b>KV 267</b>
K 82306	<b>KA 034</b>
K 82311	<b>KF 129</b>
K 82312	<b>KB 217</b>
K 82315	<b>KF 130</b>
K 82319	<b>KF 321</b>
K 82350	<b>KA 035</b>
K 82351	<b>KA 131</b>
K 82353	<b>KC 132</b>
K 82358	<b>KA 037</b>
K 82364	<b>KA 268</b>
K 82501	<b>KF 133</b>
K 82502	<b>KA 038</b>
K 82504	<b>KA 039</b>
K 82505	<b>KA 040</b>
K 82510	<b>KV 135</b>
K 82512	<b>KF 136</b>
K 82513	<b>KV 235</b>
K 82516	<b>KF 137</b>
K 82517	<b>KV 202</b>
K 82518	<b>KF 138</b>
K 82523	<b>KV 196</b>
K 82524	<b>KV 198</b>
K 82525	<b>KV 247</b>
K 82527	<b>KV 279</b>

TIMKEN	Fersa
K 82528	<b>KV 252</b>
K 82529	<b>KF 342</b>
K 82530	<b>KF 341</b>
K 82539	<b>KF 292</b>
K 82540	<b>KB 338</b>
K 82542	<b>KV 199</b>
K 82545	<b>KF 340</b>
K 82546	<b>KB 339</b>
K 82604	<b>KF 139</b>
K 82605	<b>KA 088</b>
K 82606	<b>KA 089</b>
K 82610	<b>KA 041</b>
K 82611	<b>KF 140</b>
K 82612	<b>KF 141</b>
K 82613	<b>KF 142</b>
K 82615	<b>KF 143</b>
K 82616	<b>KV 144</b>
K 82619	<b>KF 145</b>
K 82620	<b>KV 305</b>
K 82622	<b>KF 289</b>
K 82623	<b>KV 290</b>
K 82901	<b>KC 146</b>
K 82902	<b>KA 042</b>
K 82903	<b>KC 147</b>
K 82904	<b>KA 043</b>
K 82907	<b>KC 148</b>
K 82908	<b>KC 149</b>
K 82909	<b>KA 044</b>
K 82910	<b>KF 150</b>
K 82911	<b>KB 048</b>
K 82912	<b>KB 045</b>
K 82913	<b>KV 152</b>
K 82915	<b>KB 046</b>
K 82916	<b>KV 154</b>
K 82917	<b>KF 155</b>
K 82918	<b>KB 047</b>
K 82920	<b>KV 156</b>
K 82923	<b>KB 090</b>
K 82926	<b>KV 157</b>
K 82927	<b>KF 158</b>
K 82932	<b>KV 258</b>
K 82936	<b>KV 244</b>
K 82937	<b>KV 243</b>
K 82945	<b>KF 312</b>
K 82949	<b>KV 246</b>
K 82950	<b>KA 255</b>
K 82952	<b>KF 314</b>
K 82955	<b>KA 091</b>
K 82959	<b>KB 278</b>
K 82962	<b>KF 195</b>
K 82963	<b>KB 192</b>
K 82963	<b>KB 262</b>
K 82965	<b>KB 193</b>
K 83050	<b>KA 050</b>
K 83051	<b>KA 051</b>
K 83053	<b>KA 052</b>

TIMKEN	Fersa	TIMKEN	Fersa
K 83054	<b>KA 053</b>	K 84012	<b>KV 178</b>
K 83104	<b>KA 054</b>	K 84018	<b>KV 271</b>
K 83105	<b>KF 159</b>	K 84021	<b>KV 242</b>
K 83107	<b>KV 286</b>	K 84023	<b>KV 234</b>
K 83109	<b>KV 287</b>	K 84024	<b>KF 302</b>
K 83202	<b>KA 210</b>	K 84025	<b>KV 245</b>
K 83204	<b>KA 055</b>	K 84028	<b>KV 249</b>
K 83205	<b>KA 056</b>	K 84101	<b>KF 183</b>
K 83206	<b>KA 057</b>	K 84101	<b>KF 179</b>
K 83207	<b>KC 253</b>	K 84103	<b>KF 180</b>
K 83210	<b>KF 203</b>	K 84105	<b>KF 181</b>
K 83210	<b>KF 160</b>	K 84106	<b>KF 182</b>
K 83212	<b>KF 161</b>	K 84106	<b>KF 216</b>
K 83213	<b>KV 162</b>	K 84108	<b>KV 276</b>
K 83214	<b>KV 163</b>	K 84110	<b>KV 285</b>
K 83215	<b>KV 204</b>	K 84150	<b>KA 070</b>
K 83216	<b>KF 261</b>	K 84151	<b>KA 071</b>
K 83223	<b>KV 164</b>	K 84153	<b>KA 072</b>
K 83224	<b>KV 218</b>	K 84157	<b>KC 256</b>
K 83226	<b>KF 165</b>	K 84160	<b>KF 233</b>
K 83227	<b>KF 166</b>		
K 83235	<b>KF 270</b>		
K 83236	<b>KF 168</b>		
K 83237	<b>KF 167</b>		
K 83237	<b>KV 237</b>		
K 83238	<b>KF 281</b>		
K 83241	<b>KF 288</b>		
K 83252	<b>KA 169</b>		
K 83253	<b>KA 170</b>		
K 83257	<b>KA 058</b>		
K 83259	<b>KA 200</b>		
K 83262	<b>KA 171</b>		
K 83301	<b>KA 059</b>		
K 83305	<b>KA 060</b>		
K 83401	<b>KC 223</b>		
K 83402	<b>KC 224</b>		
K 83403	<b>KF 301</b>		
K 83451	<b>KC 265</b>		
K 83452	<b>KB 062</b>		
K 83601	<b>KF 172</b>		
K 83602	<b>KA 063</b>		
K 83603	<b>KA 064</b>		
K 83705	<b>KF 173</b>		
K 83710	<b>KA 065</b>		
K 83720	<b>KF 352</b>		
K 83729	<b>KF 298</b>		
K 83730	<b>KF 197</b>		
K 83753	<b>KA 066</b>		
K 83754	<b>KA 067</b>		
K 83756	<b>KC 174</b>		
K 84 006	<b>KA 212</b>		
K 84001	<b>KA 068</b>		
K 84008	<b>KA 211</b>		
K 84009	<b>KF 175</b>		
K 84010	<b>KF 176</b>		
K 84011	<b>KV 177</b>		

TIMKEN	Fersa	TIMKEN	Fersa
K 83054	KA 053	K 84012	KV 178
K 83104	KA 054	K 84018	KV 271
K 83105	KF 159	K 84021	KV 242
K 83107	KV 286	K 84023	KV 234
K 83109	KV 287	K 84024	KF 302
K 83202	KA 210	K 84025	KV 245
K 83204	KA 055	K 84028	KV 249
K 83205	KA 056	K 84101	KF 183
K 83206	KA 057	K 84101	KF 179
K 83207	KC 253	K 84103	KF 180
K 83210	KF 203	K 84105	KF 181
K 83210	KF 160	K 84106	KF 182
K 83212	KF 161	K 84106	KF 216
K 83213	KV 162	K 84108	KV 276
K 83214	KV 163	K 84110	KV 285
K 83215	KV 204	K 84150	KA 070
K 83216	KF 261	K 84151	KA 071
K 83223	KV 164	K 84153	KA 072
K 83224	KV 218	K 84157	KC 256
K 83226	KF 165	K 84160	KF 233
K 83227	KF 166		
K 83235	KF 270		
K 83236	KF 168		
K 83237	KF 167		
K 83237	KV 237		
K 83238	KF 281		
K 83241	KF 288		
K 83252	KA 169		
K 83253	KA 170		
K 83257	KA 058		
K 83259	KA 200		
K 83262	KA 171		
K 83301	KA 059		
K 83305	KA 060		
K 83401	KC 223		
K 83402	KC 224		
K 83403	KF 301		
K 83451	KC 265		
K 83452	KB 062		
K 83601	KF 172		
K 83602	KA 063		
K 83603	KA 064		
K 83705	KF 173		
K 83710	KA 065		
K 83720	KF 352		
K 83729	KF 298		
K 83730	KF 197		
K 83753	KA 066		
K 83754	KA 067		
K 83756	KC 174		
K 84 006	KA 212		
K 84001	KA 068		
K 84008	KA 211		
K 84009	KF 175		
K 84010	KF 176		
K 84011	KV 177		

Fersa BEARING

Fersa KIT	BEARING	BEARING
KA 001	L 45449 / 10	LM 11749 / 10
KA 002	L 44649 / 10	LM 11749 / 10
KA 003	L 45449 / 10	LM 11949 / 10
KA 004	LM 67048 / 10	LM 11949 / 10
KA 005	L 45449 / 10	LM 11949 / 10
KA 006	L 45449 / 10	LM 11749 / 10
KA 007	L 45449 / 10	LM 11749 / 10
KB 008	F 15041	
KA 009	32010 XF	32010 XF
KA 010	32006 XF	32008 XF
KB 011	F 15166	
KB 012	F 15166	
KA 013	32006 XF	32008 XF
KA 014	L 44649 / 10	LM 11749 / 10
KA 015	F 15036	F 15036
KA 016	L 45449 / 10	LM 11749 / 10
KA 017	L 44649 / 10	LM 11749 / 10
KA 018	F 15036	F 15036
KA 019	F 15036	F 15036
KA 020	F 15040	F 15040
KA 021	F 15029	F 15029
KA 022	F 15055	F 15055
KA 023	LM 48548 / 10	M 12649 / 10
KA 024	32008 XF	32008 XF
KA 025	LM 67048 / 10	LM 11949 / 10
KA 026	L 503349 A/10	LM 300849 /11
KA 027	LM 48548 / 10	M 12649 / 10
KA 028	LM 67048 / 10	LM 11949 / 10
KA 029	LM 48548 / 10	M 12649 / 10
KA 030	LM 67048 / 10	LM 11749 / 10
KA 031	32009 XF	32009 XF
KA 032	30209 F	30306 F
KA 033	32009 XF	L 503349 A /10
KA 034	L 44649 / 10	LM 11949 / 10
KA 035	30209 F	LM 501349 / 10
KA 036	LM 67048 / 10	LM 11949 / 10
KA 037	32010 XF	32010 XF
KA 038	L 45449 / 10	LM 11749 / 10
KA 039	LM 67048 / 10	LM 11949 / 10
KA 040	L 44649 / 10	LM 11749 / 10
KA 041	320 / 32	32005 XR
KA 042	30203 F	F 15063
KA 043	30205 F	30204 F
KA 044	32005 XR	32004 XF
KB 045	F 15041	
KB 046	F 15042	
KB 047	F 15043	
KB 048	F 15044	
KA 049	32007 XF	30205 F
KA 050	LM 603049/11	LM 603049/11
KA 051	359 A / 354 X	11162 / 300
KA 052	LM 603049/11	LM 603049/11
KA 053	LM 603049/11	LM 603049/11
KA 054	LM 67048 / 10	30204 F

Fersa KIT	BEARING	BEARING
KA 055	15579 X/20	LM 11949/10
KA 056	LM 67048/10	LM 11949/10
KA 057	J 15585/20	LM 11949/10
KA 058	32008 XF	32006 XF
KA 059	L 44649 / 10	LM 11749 / 10
KA 060	L 44649 / 10	30204 F
KA 061	F 15003	F 15003
KB 062	F 15015	
KA 063	L 44649 / 10	30204 F
KA 064	LM 67048/10	LM 11949/10
KA 065	L 45449 / 10	LM 11749 / 10
KA 066	LM 67048/10	LM 11949/10
KA 067	LM 67048/10	LM 11949/10
KA 068	L 44649 / 10	LM 11749 / 10
KA 069	L 45449 / 10	LM 11749 / 10
KA 070	LM 48548 / 10	M 12649 / 10
KA 071	LM 300849/11	L 45449 / 10
KA 072	32010 XF	32010 XF
KA 073	32005 XR	32004 XF
KA 074	F 15135	F 15135
KA 075	L 45449 / 10	LM 11749 / 10
KA 076	F 15036	F 15036
KA 077	L 45449 / 10	LM 11949/10
KB 078	F 15041	
KA 079	32010 XF	32010 XF
KA 080	33108 F	32206 F
KA 081	F 15036	F 15036
KA 082	F 15036	F 15036
KA 083	LM 67048/10	LM 11949/10
KA 084	387 A / 382 A	18790 / 20
KA 085	32007 XR	LM 11949/10
KA 086	L 44649 / 10	LM 11749 / 10
KA 087	L 45449 / 10	LM 11749 / 10
KA 088	30205 F	30204 F
KA 089	30205 F	30204 F
KB 090	F 15050	
KA 091	320/32 XF	32005 XR
KF 092	F 16045	
KF 093	F 16045	
KF 094	F 16031	
KF 095	F 16035	
KF 096	F 16038	
KV 097	F 16011	
KF 098	F 16054	
KF 099	F 16041	
KV 100	F 16008	
KF 101	F 16052	
KF 102	F 16053	
KV 103	F 16015	
KF 104	F 16036	
KV 105	F 16060	
KF 106	F 16046	
KF 107	F 16032	
KV 108	F 16033	





Fersa KIT	BEARING	BEARING
KF 109	F 16036	
KF 110	F 16046	
KF 111	F 16022	
KF 112	F 16004	
KF 113	F 16056	
KV 114	F 16016	
KF 115	F 16036	
KF 116	F 16055	
KD 117	F 18009	
KD 118	F 18009	
KF 119	F 16091	
KV 120	F 16006	
KF 121	F 16090	
KV 122	F 16014	
KV 123	F 16014	
KF 124	F 16059	
KB 125	F 15167	
KA 126	U 497/U 460L	
KF 127	F 16059	
KF 128	F 16081	
KF 129	F 16058	
KF 130	F 16034	
KA 131	32209 F	32209 F
KC 132	F 18003	
KF 133	F 16019	
KF 134	F 16036	
KV 135	F 16028	
KF 136	F 16032	
KF 137	F 16020	
KF 138	F 16037	
KF 139	F 16042	
KF 140	F 16049	
KF 141	F 16050	
KF 142	F 16026	
KF 143	F 16048	
KV 144	F 16017	
KF 145	F 16029	
KC 146	F 18001	
KC 147	F 18006	
KC 148	F 18001	F 18002
KC 149	F 18005	
KF 150	F 16025	
KF 151	F 16021	
KV 152	F 16044	
KF 153	F 16051	
KV 154	F 16005	
KF 155	F 16030	
KV 156	F 16061	
KV 157	F 16007	
KF 158	F 16031	
KF 159	F 16024	
KF 160	F 16002	
KF 161	F 16001	
KV 162	F 16062	

Fersa KIT	BEARING	BEARING
KV 163	F 16003	
KV 164	F 16010	
KF 165	F 16027	
KF 166	F 16031	
KF 167	F 16031	
KF 168	F 16027	
KA 169	32208 F	30305 F
KA 170	32011 XF	32011 XF
KA 171	368 A/362 A	18690/18620
KF 172	F 16043	
KF 173	F 16009	
KC 174	F 18010	
KF 175	F 16024	
KF 176	F 16024	
KV 177	F 16012	
KV 178	F 16013	
KF 179	F 16019	
KF 180	F 16018	
KF 181	F 16023	
KF 182	F 16039	
KF 183	F 16106	
KF 184	F 16040	
KF 185	F 16035	
KA 186	30208 F	
KA 187	L 45449 / 10	L 45449 / 10
KC 188	F 18004	
KA 189	L 68149 / 11	LM 12749 / 10
KA 190	LM 102949 / 10	LM 102949 / 10
KB 191	F 15067	
KB 192	F 15044	
KB 193	F 15041	
KV 194	F 16065	
KF 195	F 16066	
KV 196	F 16067	
KF 197	F 16068	
KV 198	F 16069	
KV 199	F 16070	
KA 200	32206 F	33108 F
KF 201	F 16036	
KV 202	F 16073	
KF 203	F 16024	
KV 204	F 16072	
KC 205	6306 2RS	
KA 206	30206 F	30304 F
KA 207	30208 F	30208 F
KA 208	30209 F	30209 F
KC 209	6306 2RS	6306 2RS
KA 210	L 44645 / L 44613	L 44645 / L 44613
KA 211	U 399 / U 360 L + COLLAR (D)	
KA 212	U 399 / U 360 L + COLLAR (E)	
KA 213	01-03-4016	05-02-4911
KA 214	JL 69349 / JL 69310	JL 69349 / JL 69310
KV 215	F 16136	
KF 216	F 16039	

Fersa BEARING

Fersa KIT	BEARING	BEARING
KB 217	F 15137	
KV 218	F 16137	
KV 219	F 16138	
KV 220	F 16139	
KV 221	F 16140	
KV 222	F 16141	
KC 223	6007 2RS / C3	6007 2RS / C3
KC 224	6205 2RS / C3	6204 2RS / C3
KF 225	F 16088	
KV 226	F 16142	
KF 227	F 16089	
KV 228	F 16143	
KV 229	F 16144	
KV 230	F 16145	
KV 231	F 16146	
KV 232	F 16147	
KF 233	F 16085	
KV 234	F 16148	
KV 235	F 16149	
KV 236	F 16150	
KV 237	F 16151	
KV 238	F 16152	
KV 239	F 16153	
KF 240	F 16086	
KF 241	F 16086	
KV 242	F 16154	
KV 243	F 16155	
KV 244	F 16156	
KV 245	F 16188	
KV 246	F 16157	
KV 247	F 16158	
KA 248	L 45449 / 10	LM 11949 / 10
KV 249	F 16159	
KV 250	F 16160	
KV 251	F 16161	
KV 252	F 16162	
KC 253	F 18044	
KA 254	LM 67049/14	
KA 255	JLM 104945 / 10	JLM 104945 / 10
KC 256	F 19074	6207 C3
KA 257	F 15164	F 15164
KV 258	F 16163	
KF 259	F 16034	
KV 260	F 16164	
KF 261	F 16031	
KB 262	F 15044	
KB 263	F 15068	
KF 264	F 16107	
KC 265	F 18045	
KA 266	30208 F	
KV 267	F 16165	
KA 268	32209 F	
KA 269	32007 XF	32205 BF
KF 270	F 16093	

Fersa KIT	BEARING	BEARING
KV 271	F 16166	
KA 272	F 15138	F 15138
KA 273	LM 501349 / 10	33205 F
KF 274	F 16132	
KV 275	F 16167	
KV 276	F 16168	
KF 277	F 16108	
KB 278	F 15168	
KV 279	F 16169	
KF 280	F 16109	
KF 281	F 16002	
KF 282	F 16110	
KF 283	F 16111	
KV 284	F 16170	
KV 285	F 16171	
KV 286	F 16172	
KV 287	F 16173	
KF 288	F 16112	
KF 289	F 16113	
KV 290	F 16174	
KV 291	F 15154	
KF 292	F 16083	
KB 293	F 15169	
KV 294	F 16175	
KB 295	F 15170	
KB 296	F 15121	
KV 297	F 16176	
KF 298	F 16068	
KF 299	F 16057	
KF 300	F 16114	
KF 301	F 16115	
KF 302	F 16116	
KF 303	F 16045	
KF 304	F 16117	
KV 305	F 16177	
KF 306	F 16054	
KF 307	F 16054	
KF 308	F 16118	
KF 309	F 16119	
KF 310	F 16120	
KF 311	F 16105	
KF 312	F 16121	
KF 313	F 16122	
KF 314	F 16051	
KF 315	F 16123	
KF 316	F 16119	
KF 317	F 16090	
KB 318	F 15172	
KF 319	F 16191	
KF 320	F 16124	
KF 321	F 16125	
KV 322	F 16178	
KV 323	F 15177	
KV 324	F 15178	

			
Fersa KIT	BEARING	BEARING	
KV 325	F 15179		
KV 326	F 15180		
KF 327	F 16036		
KV 328	F 16179		
KF 329	F 16126		
KV 330	F 16180		
KV 331	F 16181		
KV 332	F 16182		
KV 333	F 16183		
KF 334	F 16127		
KV 335	F 16184		
KV 336	F 16185		
KV 337	F 16186		
KB 338	F 15128		
KB 339	F 15173		
KF 340	F 16128		
KF 341	F 16129		
KF 342	F 16130		
KV 343	F 16187		
KB 344	F 15174		
KB 345	F 15043		
KF 346	F 16131		
KA 347	F 15164	F 15164	
KF 348	F 16132		
KA 349	30206 F	30304 F	
KB 350	F 15175		
KF 351	F 16133		
KF 352	F 16134		
KV 353	F 16192		
KF 354	F 16135		

10. Cross references list

KIT	BEARING	BEARING	SKF	FAG	SNR	TIMKEN	QH
KA 001	L 45449 / 10	LM 11749 / 10	VKBA 532	713606200	R 160.02	K 80102	QWB 211
KA 002	L 44649 / 10	LM 11749 / 10	VKBA 513	713606020	R 160.04	K 80103	QWB 212
KA 003	L 45449 / 10	LM 11949 / 10	VKBA 1487	713606140	R 160.06	K 80104	QWB 443
KA 004	LM 67048 / 10	LM 11949 / 10	VKBA 718	713606050	R 160.19	K 80113	QWB 691
KA 005	L 45449 / 10	LM 11949 / 10	VKBA 542	713610240	R 157.05	K 80202	QWB 429
KA 006	L 45449 / 10	LM 11749 / 10	VKBA 529	713610230	R 154.13	K 80203	QWB 201
KA 007	L 45449 / 10	LM 11749 / 10	VKBA 3255	713644510	R 153.07	K 80403	
KB 008	F 15041		VKBA 961	713650070	R 159.19	K 80712	QWB 503
KA 009	32010 XF	32010 XF	VKBA 844	713690330	R 140.42	K 80750	QWB 481
KA 010	32006 XF	32008 XF	VKBA 845	713690430	R 140.43	K 80751	QWB 545
KB 011	F 15166		VKBA 813	713690320	R 140.02	K 80752	QWB 486
KB 012	F 15166		VKBA 814	713690420	R 140.03	K 80153	QWB 482
KA 013	32006 XF	32008 XF	VKBA 3429	713650420	R 140.95	K 80756	QWB 996
KA 014	L 44649 / 10	LM 11749 / 10	VKBA 504	713678250	R 152.12	K 81102	QWB 113C
KA 015	F 15036	F 15036	VKBA 686	713678190	R 152.16	K 81103	QWB 420
KA 016	L 45449 / 10	LM 11749 / 10	VKBA 528	713678150	R 152.17	K 81104	QWB 414
KA 017	L 44649 / 10	LM 11749 / 10	VKBA 505	713678140	R 152.08	K 81107	QWB 115C
KA 018	F 15036	F 15036	VKBA 740	713678080	R 152.21	K 81109	QWB 569
KA 019	F 15036	F 15036	VKBA 687	713678090	R 152.19	K 81111	QWB 418
KA 020	F 15040	F 15040	VKBA 1431	713678020	R 152.36	K 81116	QWB 696
KA 021	F 15029	F 15029	VKBA 1333	713678320	R 152.37	K 81117	QWB 697
KA 022	F 15055	F 15055	VKBA 1366	713619130	R 173.15	K 81201	QWB 638
KA 023	LM 48548 / 10	M 12649 / 10	VKBA 1369	713619300	R 140.34	K 81209	QWB 692
KA 024	32008 XF	32008 XF	VKBA 1324	713690090	R 172.01	K 81850	QWB 725
KA 025	LM 67048 / 10	LM 11949 / 10	VKBA 517	-	R 151.02	K 82001	QWB 256
KA 026	L 503349 A /10	LM 300849 /11	VKBA 614	713667520	R 151.03	K 82002	QWB 259
KA 027	LM 48548 / 10	M 12649 / 10	VKBA 596	713667430	R 151.05	K 82003	QWB 255
KA 028	LM 67048 / 10	LM 11949 / 10	VKBA 941	713667370	R 151.14	K 82006	QWB 654
KA 029	LM 48548 / 10	M 12649 / 10	VKBA 1337	-	R 151.12	K 82008	QWB 659
KA 030	LM 67048 / 10	LM 11749 / 10	VKBA 756	713667450	R 151.08	K 82009	QWB 508
KA 031	32009 XF	32009 XF	-	-		K 82056	
KA 032	30209 F	30306 F	VKBA 3405	713667570	R 140.73	K 82057	QWB 1198
KA 033	32009 XF	L 503349 A /10	VKBA 3404	713667300	R 140.72	K 82058	QWB 1197
KA 034	L 44649 / 10	LM 11949 / 10	VKBA 1310	713613280	R 168.15	K 82306	QWB 539
KA 035	30209 F	LM 501349 / 10	VKBA 3319	713613160	R 168.50	K 82350	QWB 815
KA 036	LM 67048 / 10	LM 11949 / 10	VKBA 684	713613130	R 168.09		QWB 347
KA 037	32010 XF	32010 XF	-	-		K 82358	
KA 038	L 45449 / 10	LM 11749 / 10	VKBA 944	713644510	R 153.07	K 82502	QWB 155C
KA 039	LM 67048 / 10	LM 11949 / 10	VKBA 526	713644520	R 153.16	K 82504	QWB 596
KA 040	L 44649 / 10	LM 11749 / 10	VKBA 506	713644480	R 153.03	K 82505	QWB 285
KA 041	320 / 32	32005 XR	VKBA 540	713650140	R 159.08	K 82610	QWB 289
KA 042	30203 F	F 15063	VKBA 564	713630200	R 155.05	K 82902	QWB 301
KA 043	30205 F	30204 F	VKBA 548	713630210	R 155.03	K 82904	QWB 629
KA 044	32005 XR	30204 XF	VKBA 652	713630220	R 155.06	K 82909	QWB 310
KB 045	F 15041		VKBA 869	713630300	R 155.13	K 82912	QWB 431
KB 046	F 15042		VKBA 975	713630240	R 155.17	K 82915	QWB 560
KB 047	F 15043		VKBA 976	713630270	R 155.27	K 82918	QWB 560
KB 048	F 15044		VKBA 1413	713630180	R 155.32	K 82911	QWB 430D
KA 049	32007 XF	30205 F	VKBA 977	713630480	R 140.56		QWB 608
KA 050	LM 603049/11	LM 603049/11	VKBA 838	713620140	R 180.00	K 83050	QWB 186C
KA 051	359 A / 354 X	11162 / 300	VKBA 837	-		K 83051	QWB 411
KA 052	LM 603049/11	LM 603049/11	VKBA 3420	713620010	R 180.01	K 83053	QWB 519
KA 053	LM 603049/11	LM 603049/11	VKBA 3421	713620020	R 180.02	K 83054	QWB 706
KA 054	LM 67048 / 10	30204 F	VKBA 1430	713614210	R 178.03	K 83104	QWB 707
KA 055	15579 X/20	LM 11949/10	VKBA 926	713690120	R 158.00	K 83204	QWB 239
KA 056	LM 67048/10	LM 11949/10	VKBA 925	713690130	R 158.01	K 83205	QWB 242
KA 057	J 15585/20	LM 11949/10	VKBA 929	713690150	R 158.08	K 83206	QWB 247

KIT	BEARING	BEARING	SKF	FAG	SNR	TIMKEN	QH
KA 058	32008 XF	32006 XF	VKBA 1446	713650410	R 140.79	K 83257	QWB 740
KA 059	L 44649 / 10	LM 11749 / 10	VKBA 501	713680110		K 83301	
KA 060	L 44649 / 10	30204 F	-	-		K 83305	
KA 061	F 15003	F 15003	VKBA 1978	713623020	R 177.02		QWB 915
KB 062	F 15015		VKBA 3219	713623030	R 177.12	K 83452	QWB 812
KA 063	L 44649 / 10	30204 F	VKBA 551	713680110		K 83602	
KA 064	LM 67048/10	LM 11949/10	VKBA 525	-		K 83603	
KA 065	L 45449 / 10	LM 11749 / 10	VKBA 534	713618100	R 169.01	K 83710	QWB 366
KA 066	LM 67048/10	LM 11949/10	VKBA 527	713618110	R 169.02	K 83753	QWB 365
KA 067	LM 67048/10	LM 11949/10	VKBA 1965	713618740	R 169.02	K 83754	QWB 365
KA 068	L 44649 / 10	LM 11749 / 10	VKBA 502	713660110	R 163.00	K 84001	QWB 342
KA 069	L 45449 / 10	LM 11749 / 10	VKBA 529	713610230		K 80203	
KA 070	LM 48548 / 10	M 12649 / 10	VKBA 826	713618300	R 140.26	K 84150	QWB 693
KA 071	LM 300849/11	L 45449 / 10	VKBA 802	713611480	R 154.17	K 84151	QWB 407
KA 072	32010 XF	32010 XF	VKBA 801	713611570	R 154.18	K 84153	QWB 496
KA 073	32005 XR	32004 XF	VKBA 728	713650270	R 159.12	K 80708	QWB 459
KA 074	F 15135	F 15135	VKBA 543	713678170	R 152.20	K 81101	QWB 184C
KA 075	L 45449 / 10	LM 11749 / 10	VKBA 528	713678150		K 81104	
KA 076	F 15036	F 15036	VKBA 897	713678280	R 152.28	K 81110	QWB 527
KA 077	L 45449 / 10	LM 11949/10	VKBA 752	713613230	R 168.10	K 80107	QWB 492
KB 078	F 15041		VKBA 3556	713650070	R 159.38	K 80737	QWB 1274
KA 079	32010 XF	32010 XF	VKBA 1444	713650310	R 140.77	K 80754	QWB 828
KA 080	33108 F	32206 F	VKBA 3430	713650430	R 140.96	K 80757	QWB 995
KA 081	F 15036	F 15036	VKBA 741	713678080	R 152.29	K 81118	QWB 568
KA 082	F 15036	F 15036	VKBA 898	713678280	R 152.34	K 81119	QWB 528
KA 083	LM 67048/10	LM 11949/10	VKBA 523	-	R 152.02	K 81150	QWB 414
KA 084	387 A / 382 A	18790 / 20	VKBA 959	713678420	R 140.80	K 81155	QWB 756
KA 085	32007 XR	LM 11949/10	VKBA 1465	713678500	R 140.87	K 81151	QWB 863
KA 086	L 44649 / 10	LM 11749 / 10	VKBA 713	713619100	R 173.00	K 81206	QWB 375
KA 087	L 45449 / 10	LM 11749 / 10	VKBA 1396	713667380	R 151.11	K 82050	QWB 773
KA 088	30205 F	30204 F	VKBA 547	713650210	R 159.04	K 82605	QWB 446
KA 089	30205 F	30204 F	VKBA 546	713640440	R 159.11	K 82606	QWB 445
KB 090	F 15050		VKBA 969	713630250	R 155.19	K 82923	QWB 662
KA 091	320/32 XF	32005 XR	VKBA 830	713630440	R 140.25	K 82955	QWB 497
KF 092	F 16045		VKBA 964	713606260	R 160.13	K 80108	QWB 672
KF 093	F 16045		VKBA 963	713606320	R 160.14	K 80115	QWB 671
KF 094	F 16031		VKBA 1447	713606160	R 160.18	K 80116	QWB 944
KF 095	F 16035		VKBA 575	713610160	R 154.15		QWB 510
KF 096	F 16038		VKBA 1355	713610080	R 157.08	K 80207	QWB 683
KV 097	F 16011		VKBA 3456	713610220	R 157.20	K 80213	QWB 1055
KF 098	F 16054		VKBA 1356	713610030	R 154.43	K 80214	QWB 733
KF 099	F 16041		VKBA 1374	713617090	R 174.12	K 80310	QWB 712
KV 100	F 16008		VKBA 1379	713617260	R 174.19	K 80312	QWB 592
KF 101	F 16052		VKBA 3461	713617360	R 161.23	K 80323	QWB 994
KF 102	F 16053		VKBA 3246	713617040	R 174.34	K 80329	QWB 1003
KV 103	F 16015		VKBA 890	-	R 150.15	K 80506	QWB 576
KF 104	F 16036		VKBA 1317	713649240	R 150.16	K 80507	QWB 906
KV 105	F 16060		VKBA 938	713667140	R 150.17	K 80515	QWB 534
KF 106	F 16046		VKBA 1320	713649270	R 150.19	K 80511	QWB 779
KF 107	F 16032		VKBA 1318	713649250	R 150.12	K 80514	QWB 514
KV 108	F 16033		VKBA 1458	713667180	R 150.22	K 80516	QWB 786
KF 109	F 16036		VKBA 1459	713649320	R 150.23	K 80517	QWB 787
KF 110	F 16046		VKBA 1460	713649300	R 150.24	K 80518	QWB 831
KF 111	F 16022		VKBA 1327	713640190	R 166.14	K 80718	QWB 634
KF 112	F 16004		VKBA 1328	713640280	R 166.15	K 80719	QWB 635
KF 113	F 16056		VKBA 3423	713630580	R 159.31	K 80724	QWB 974
KV 114	F 16016		VKBA 3477	713630530	R 166.24		QWB 1049

10. Cross references list

KIT	BEARING	BEARING	SKF	FAG	SNR	TIMKEN	QH
KF 115	F 16036		VKBA 1432	713678040	R 152.39	K 81120	QWB 817
KF 116	F 16055		VKBA 1480	713678050	R 152.42	K 81125	QWB 859
KD 117	F 18009		VKBA 922	713678380	R 140.52	K 81151	QWB 194C
KD 118	F 18009		VKBA 958	-	R 140.70	K 81156	QWB 633
KF 119	F 16091		VKBA 3309	713619090			
KV 120	F 16006		VKBA 3305	713619080	R 173.23	K 81214	QWB 984
KF 121	F 16090		VKBA 1970	713619170			
KV 122	F 16014		VKBA 3326	713619410	R 173.17	K 81220	QWB 988
KV 123	F 16014		VKBA 3327	713619420	R 173.18	K 81221	
KF 124	F 16059		VKBA 757	713667530	R 151.07	K 82005	QWB 536
KB 125	F 15167		VKBA 1347	713667550	R 151.15	K 82007	QWB 754
KA 126	U 497/U 460L		VKBA 1470	713667560	R 151.10	K 82053	QWB 752
KF 127	F 16059		VKBA 3486	713667050	R 151.27	K 82068	QWB 1057
KF 128	F 16081		VKBA 1999	713613700	R 168.26	K 82301	QWB 956
KF 129	F 16058		VKBA 1362	713613090	R 168.18	K 82311	QWB 931
KF 130	F 16034		VKBA 3201	713613040	R 168.30	K 82315	QWB 928
KA 131	32209 F	32209 F	VKBA 1953	713613070	R 168.41	K 82351	
KC 132	F 18003		VKBA 673	713613220	R 168.04	K 82353	QWB 354
KF 133	F 16019		VKBA 663	713644160	R 153.14	K 82501	QWB 417
KF 134	F 16036		VKBA 736	713644170	R 153.15	K 80402	QWB 436
KV 135	F 16028		VKBA 1301	713644540	R 153.18	K 82510	QWB 603
KF 136	F 16032		VKBA 1326	713644650	R 153.20	K 82512	QWB 570
KF 137	F 16020		VKBA 3403	713644150	R 153.25	K 82516	QWB 935
KF 138	F 16037		VKBA 3410	713644190	R 153.26	K 82518	QWB 878
KF 139	F 16042		VKBA 618	713650110	R 159.07	K 82604	QWB 507
KF 140	F 16049		VKBA 622	713650240	R 159.03	K 82611	QWB 291
KF 141	F 16050		VKBA 729	713650260	R 159.13	K 82612	QWB 461
KF 142	F 16026		VKBA 882	713650160	R 159.14	K 82613	QWB 487
KF 143	F 16048		VKBA 915	713640180	R 166.13	K 82615	QWB 525
KV 144	F 16017		VKBA 743	713640260	R 159.15	K 82616	QWB 488
KF 145	F 16029		VKBA 3554	713650060	R 159.17	K 82619	QWB 1150
KC 146	F 18001		VKBA 629	713630100	R 155.00	K 82901	QWB 302
KC 147	F 18006		VKBA 639	713630120	R 155.01	K 82903	QWB 286
KC 148	F 18001	F 18002	VKBA 636	713630130	R 155.10	K 82907	QWB 302
KC 149	F 18005		VKBA 723	713630150	R 155.08	K 82908	QWB 313
KF 150	F 16025		VKBA 638	713630160	R 155.21	K 82910	QWB 309
KF 151	F 16021		VKBA 1413	-			
KV 152	F 16044		VKBA 966	713630170	R 155.11	K 82913	QWB 467
KF 153	F 16051		VKBA 909	713630340	R 155.09	K 89914	QWB 479
KV 154	F 16005		VKBA 967	-	R 155.15	K 82916	QWB 563
KF 155	F 16030		VKBA 3596	-	R 155.16	K 82917	QWB 564
KV 156	F 16061		VKBA 1406	713630350	R 155.24	K 82920	QWB 681
KV 157	F 16007		VKBA 1494	713630310	R 155.26	K 82926	QWB 563
KF 158	F 16031		VKBA 3408	-	R 155.16	K 82927	
KF 159	F 16024		VKBA 3441	713614030	R 154.49	K 83105	QWB 811
KF 160	F 16002		VKBA 685	713690170	R 158.12	K 83210	QWB 422
KF 161	F 16001		VKBA 559	713690160	R 158.07	K 83212	QWB 243
KV 162	F 16062		VKBA 625	713690240	R 158.10	K 83213	QWB 421
KV 163	F 16003		VKBA 734	713690010	R 158.13	K 83214	QWB 515
KV 164	F 16010		VKBA 1440	713690230	R 158.22	K 83223	QWB 675
KF 165	F 16027		VKBA 1438	-	R 158.31	K 83226	QWB 794
KF 166	F 16031		VKBA 1439	713690510	R 158.32	K 83227	QWB 795
KF 167	F 16031		VKBA 3416	713690610	R 158.37	K 83237	
KF 168	F 16027		VKBA 3414	713690500	R 158.35	K 83236	QWB 855
KA 169	32208 F	30305 F	VKBA 1385	713690380	R 140.58	K 83252	QWB 666
KA 170	32011 XF	32011 XF	VKBA 1393	713690470	R 140.65	K 83253	QWB 685
KA 171	368 A/362 A	18690/18620	VKBA 1387	-	R 140.60	K 83262	QWB 718

KIT	BEARING	BEARING	SKF	FAG	SNR	TIMKEN	QH
KF 172	F 16043		VKBA 738	713680160	R 156.04	K 83601	QWB 231
KF 173	F 16009		VKBA 1344	713618270	R 169.10	K 83705	QWB 622
KC 174	F 18010		VKBA 675	713618210	R 169.04	K 83756	QWB 360
KF 175	F 16024		VKBA 1315	713660190	R 165.11	K 84009	QWB 759
KF 176	F 16024		VKBA 1495	713660050	R 165.16	K 84010	QWB 1284
KV 177	F 16012		VKBA 1436	713660280	R 165.10	K 84011	QWB 726
KV 178	F 16013		VKBA 1437	713660270	R 165.15	K 84012	QWB 971
KF 179	F 16019		VKBA 593	713610140	R 154.14	K 84101	QWB 328
KF 180	F 16018		VKBA 577	713610130	R 154.12	K 84103	QWB 200
KF 181	F 16023		VKBA 906	713610180	R 154.23	K 84105	QWB 512
KF 182	F 16039		VKBA 1358	713610100	R 154.28	K 84106	QWB 698
KF 183	F 16106		VKBA 1491	713610040	R 154.34	K 84101	QWB 880
KF 184	F 16040		VKBA 3455	713610020	R 154.01	K 80212	QWB 1089
KF 185	F 16035		VKBA 575	713610160			
KA 186	30208 F		VKBA 1956	713619240	R 173.07	K 81208	QWB 747
KA 187	L 45449 / 10	L 45449 / 10	VKBA 1367	713619230	R 173.09	K 81211	QWB 803
KC 188	F 18004		VKBA 1371	713619210	R 173.05	K 81223	QWB 376
KA 189	L 68149 / 11	LM 12749 / 10	VKBA 1498	713667360	R 151.18	K 82011	QWB 1070
KA 190	LM 102949 / 10	LM 102949 / 10	VKBA 1915	713619140	R 173.06	K 81207	QWB 716
KB 191	F 15067		VKBA 3532	713678030	R 152.56	K 81141	QWB 1128
KB 192	F 15044		VKBA 3496	713630180		K 82963	
KB 193	F 15041		VKBA 3525	-	R 155.63	K 82965	QWB 1088
KV 194	F 16065		VKBA 3456	713610220		K 80213	
KF 195	F 16066		VKBA 3495	713630050	R 155.44	K 82962	QWB 1084
KV 196	F 16067		VKBA 3510	713644040	R 153.31	K 82523	QWB 1112
KF 197	F 16068		VKBA 3730	713618560	R 169.37	K 83730	
KV 198	F 16069		VKBA 3511	713644070	R 153.32	K 82524	QWB 1113
KV 199	F 16070		VKBA 3513	713644060	R 153.33	K 82542	QWB 1114
KA 200	32206 F	33108 F	VKBA 1462	713690490	R 140.83	K 83259	
KF 201	F 16036		VKBA 3530	713678110	R 152.54	K 81139	QWB 1126
KV 202	F 16073		VKBA 3409	713644560	R 153.23	K 82517	QWB 877
KF 203	F 16024		VKBA 1410	713696100	R 182.60	K 83210	QWB 422
KV 204	F 16072		VKBA 310	713690260	R 158.14	K 83215	QWB 509
KC 205	6306 2RS		VKBA 973	713690190	R 172.00	K 81802	QWB 254
KA 206	30206 F	30304 F	-	-			
KA 207	30208 F	30208 F	-	-			
KA 208	30209 F	30209 F	-	-			
KC 209	6306 2RS	6306 2RS	-	-			
KA 210	L 44645 / L 44613	L 44645 / L 44613	VKBA 562	713690210	R 158.04	K 83202	QWB 241
KA 211	U 399 / U 360 L + COLLAR (D)		VKBA 571	713660230	R 165.03	K 84008	QWB 337
KA 212	U 399 / U 360 L + COLLAR (E)		VKBA 733	713660260	R 165.05	K 84 006	QWB 599
KA 213	01-03-4016	05-02-4911	VKBA 927	713690110	R 158.02		QWB 249
KA 214	JL 69349 / JL 69310	JL 69349 / JL 69310	VKBA 949	713615150	R 170.09		QWB 722
KV 215	F 16136		VKBA 1331	713650250	R 159.22	K 80723	QWB 678
KF 216	F 16039		VKBA 1358	713610730		K 84106	
KB 217	F 15137		VKBA 1363	713613210	R 168.19	K 82312	QWB 763
KV 218	F 16137		VKBA 1441	713690600	R 158.21	K 83224	QWB 734
KV 219	F 16138		VKBA 1475	713640250	R 159.29	K 80122	QWB 830
KV 220	F 16139		VKBA 1481	713678340	R 152.43	K 81126	QWB 860
KV 221	F 16140		VKBA 1482	713678350	R 152.44	K 81127	QWB 862
KV 222	F 16141		VKBA 1484	713678360	R 152.45	K 81129	QWB 861
KC 223	6007 2RS / C3	6007 2RS / C3	VKBA 1930	-	R 177.09	K 83401	QWB 896
KC 224	6205 2RS / C3	6204 2RS / C3	VKBA 1931	713623120	R 177.08	K 83402	QWB 972
KF 225	F 16088		VKBA 1948	713615090	R 170.32	K 81906	QWB 889
KV 226	F 16142		VKBA 1949	713615510	R 170.23	K 81907	QWB 891
KF 227	F 16089		VKBA 1950	713615030	R 170.22	K 81905	QWB 890



10. Cross references list

KIT	BEARING	BEARING	SKF	FAG	SNR	TIMKEN	QH
KV 228	F 16143		VKBA 3218	713619280	R 173.16		QWB 842
KV 229	F 16144		VKBA 3250	713617070	R 174.28	K 80326	QWB 965
KV 230	F 16145		VKBA 3266	713619050	R 184.02	K 81204	QWB 1081
KV 231	F 16146		VKBA 3267	713619060	R 184.03	K 81203	QWB 1079
KV 232	F 16147		VKBA 3298	713615530	R 170.24	K 81908	QWB 921
KF 233	F 16085		VKBA 3406	713610300	R 140.97	K 84160	QWB 997
KV 234	F 16148		VKBA 3418	713660080	R 165.20	K 84023	QWB 1202
KV 235	F 16149		VKBA 3422	713644550	R 153.22	K 82513	QWB 876
KV 236	F 16150		VKBA 3424	713630570	R 159.32	K 80125	QWB 1001
KV 237	F 16151		VKBA 3442	713690550	R 158.39	K 83237	QWB 964
KV 238	F 16152		VKBA 3444	713667220	R 150.30	K 80520	QWB 1200
KV 239	F 16153		VKBA 3445	713649340	R 150.29	K 80521	QWB 1201
KF 240	F 16086		VKBA 3449	713610450	R 154.41	K 81135	QWB 1000
KF 241	F 16086		VKBA 3450	713610460	R 154.42	K 81136	QWB 1146
KV 242	F 16154		VKBA 3458	713660120	R 165.22	K 84021	QWB 1233
KV 243	F 16155		VKBA 3468	713630630	R 155.47	K 82937	QWB 952
KV 244	F 16156		VKBA 3469	713630640	R 155.46	K 82936	QWB 951
KV 245	F 16188		VKBA 3488	713660370	R 165.23	K 84025	QWB 1039
KV 246	F 16157		VKBA 3491	713630650	R 155.56	K 82949	QWB 1131
KV 247	F 16158		VKBA 3512	713644030	R 153.30	K 82525	QWB 1117
KA 248	L 45449 / 10	LM 11949 / 10	VKBA 3519	713610370	R 154.50	K 80215	QWB 1155
KV 249	F 16159		VKBA 3526	713660310	R 165.26	K 84028	QWB 1241
KV 250	F 16160		VKBA 3536	713610380	R 157.26	K 80217	QWB 1272
KV 251	F 16161		VKBA 3540	713690710	R 158.46	K 80125	QWB 1101
KV 252	F 16162		VKBA 3555	713644570	R 153.27	K 82528	QWB 879
KC 253	F 18044		VKBA 607	713690200	R 158.11	K 83207	QWB 177C
KA 254	LM 67049/14		VKBA 749	713620130	R 161.09	K 80334	QWB 159C
KA 255	JLM 104945 / 10	JLM 104945 / 10	VKBA 829	713630330	R 140.23	K 82950	QWB 474
KC 256	F 19074	6207 C3	VKBA 910	713611550	R 154.08	K 84157	QWB 406
KA 257	F 15164	F 15164	VKBA 919	713678290	R 152.33	K 81115	QWB 533
KV 258	F 16163		VKBA 968	713630380	R 155.18	K 82932	QWB 872
KF 259	F 16034		VKBA 1340	713618150	R 169.50		QWB 623
KV 260	F 16164		VKBA 1375	713617270	R 174.16	K 80313	QWB 742
KF 261	F 16031		VKBA 1403	713690070	R 158.18	K 83216	QWB 735
KB 262	F 15044		VKBA 3496	713630180		K 82963	
KB 263	F 15068		VKBA 1467	713678610	R 140.85	K 81159	QWB 865
KF 264	F 16107		VKBA 1488	713690540	R 160.15	K 80119	QWB 846
KC 265	F 18045		VKBA 1971	713623090	R 177.11	K 83451	
KA 266	30208 F		VKBA 3206	713613410	R 140.91		QWB 658
KV 267	F 16165		VKBA 3225	713613640	R 168.24	K 82302	QWB 868
KA 268	32209 F		VKBA 3321	713613590	R 168.52	K 82364	QWB 816
KA 269	32007 XF	32205 BF	VKBA 3407	713630550	R 140.81		QWB 942
KF 270	F 16093		VKBA 3413	713690780	R 158.34	K 83235	QWB 854
KV 271	F 16166		VKBA 3415	713660040	R 165.17	K 84018	QWB 978
KA 272	F 15138	F 15138	VKBA 3428	713640400	R 140.94	K 80755	QWB 1005
KA 273	LM 501349 / 10	33205 F	VKBA 3434	713667600	R 140.76	K 82066	QWB 1196
KF 274	F 16132		VKBA 3447	-	R 150.25		QWB 1194
KV 275	F 16167		VKBA 3480	713630090	R 166.26	K 80732	QWB 1152
KV 276	F 16168		VKBA 3489	713610500	R 154.44	K 84108	QWB 1137
KF 277	F 16108		VKBA 3492	713630830	R 155.61		QWB 1096
KB 278	F 15168		VKBA 3500	713630790	R 155.64	K 82959	QWB 1085
KV 279	F 16169		VKBA 3514	713644020	R 153.34	K 82527	QWB 1115
KF 280	F 16109		VKBA 3522	713667740	R 151.26	K 82017	QWB 1195
KF 281	F 16002		VKBA 3528	713690670	R 158.41	K 83238	
KF 282	F 16110		VKBA 3531	713678100	R 152.55	K 81140	QWB 1127
KF 283	F 16111		VKBA 3581	-	R 158.43	K 80124	QWB 1097
KV 284	F 16170		VKBA 3548	713610210	R 154.45		QWB 1257

KIT	BEARING	BEARING	SKF	FAG	SNR	TIMKEN	QH
KV 285	F 16171		VKBA 3550	713610530	R 154.52	K 84110	
KV 286	F 16172		VKBA 3567	713610490	R 157.31	K 83107	QWB 1160
KV 287	F 16173		VKBA 3569	713610470	R 157.32	K 83109	QWB 1159
KF 288	F 16112		VKBA 3577	713690860	R 158.42	K 83241	QWB 1098
KF 289	F 16113		VKBA 3584	713630760	R 159.44	K 82622	QWB 1265
KV 290	F 15154		VKBA 3585	713630820	R 159.42	K 82623	QWB 1228
KV 291	F 15176		VKBA 3588	713678650	R 152.60	K 81160	QWB 1258
KF 292	F 16083		VKBA 3600	713644080	R 153.39	K 82539	QWB 1211
KB 293	F 15169		VKBA 3613	713630800	R 140.06		QWB 1225
KV 294	F 16175		VKBA 3635	713640010	R 159.46		QWB 1273
KB 295	F 15170		VKBA 3640	713640390	R 140.17		
KB 296	F 15121		VKBA 3641	713640400	R 140.38		
KV 297	F 16176		VKBA 3667	713667060	R 150.22		QWB 786
KF 298	F 16068		VKBA 3729	713618550	R 169.38	K 83729	QWB 946
KF 299	F 16057		VKBA 3907	713619510	R 184.05	K 81229	
KF 300	F 16114		VKBA 3628	713667730			
KF 301	F 16115		VKBA 1933	713623060	R 177.06	K 83403	QWB 959
KF 302	F 16116		VKBA 3647	713660130	R 165.24	K 84024	QWB 1231
KF 303	F 16045		VKBA 3499	713667230	R 150.31		QWB 1223
KF 304	F 16117		VKBA 3245	713617030	R 174.25	K 80328	QWB 1002
KV 305	F 16177		VKBA 3546	713630540	R 159.40	K 82620	QWB 1276
KF 306	F 16054		VKBA 1356	713610350		K 80214	
KF 307	F 16054		VKBA 1356	713610410		K 80206	
KF 308	F 16118		VKBA 3427	713610070	R 157.16	K 80208	QWB 1154
KF 309	F 16119		VKBA 3945	713618760	R 169.60		
KF 310	F 16120		VKBA 3216	713618040	R 169.24		
KF 311	F 16105			713618790			
KF 312	F 16121		VKBA 3504	713630710	R 155.52	K 82945	QWB 1083
KF 313	F 16122		VKBA 3490	713630060	R 166.28	K 80734	
KF 314	F 16051		VKBA 908	713630370	R 155.09	K 82952	QWB 498
KF 315	F 16123		VKBA 3616	713644130	R 155.71		QWB 1252
KF 316	F 16119		VKBA 3237	713618180	R 169.36		QWB 899
KF 317	F 16090		VKBA 1973	713619150	R 173.10		
KB 318	F 15172		VKBA 3311	713613690			
KF 319	F 16191		VKBA 6643	713644300			
KF 320	F 16124		VKBA 1377	713617160	R 174.13	K 80309	QWB 490
KF 321	F 16125		VKBA 3703	713613630	R 168.40	K 82319	QWB 941
KV 322	F 16178		VKBA 3660	713678790	R 152.62		
KV 323	F 15177		VKBA 3654	713678730	R 152.67		
KV 324	F 15178		VKBA 3655	713678720	R 152.66		
KV 325	F 15179		VKBA 3589	713678670	R 152.58	K 81161	QWB 1259
KV 326	F 15180		VKBA 3590	713678660	R 152.59	K 81162	QWB 1260
KF 327	F 16036		VKBA 1432	713678040		K 81120	
KV 328	F 16179		VKBA 3576	713678430	R 152.24	K 81144	QWB 1236
KF 329	F 16126		VKBA 3575	713678410	R 152.23	K 81143	QWB 1261
KV 330	F 16180		VKBA 3652	713644340	R 153.50		
KV 331	F 16181		VKBA 3653	713644330	R 153.49		
KV 332	F 16182		VKBA 3651	713644320	R 153.48		
KV 333	F 16183		VKBA 3650	713644310	R 153.47		
KF 334	F 16127		VKBA 3648	713644290	R 155.74		
KV 335	F 16184		VKBA 6507	713644270	R 153.43		
KV 336	F 16185		VKBA 3624	713619450	R 153.41		QWB 1076
KV 337	F 16186		VKBA 3602	713644230	R 153.38		
KB 338	F 15128		VKBA 3601	713644220	R 153.37	K 82540	QWB 1212
KB 339	F 15173		VKBA 3617	713644140	R 155.70	K 82546	QWB 1253
KF 340	F 16128		VKBA 3618	713644120	R 155.69	K 82545	QWB 1251
KF 341	F 16129		VKBA 3572	713644110	R 153.36	K 82530	

10. Cross references list

KIT	BEARING	BEARING	SKF	FAG	SNR	TIMKEN	QH
<b>KF 342</b>	F 16130		VKBA 3571	713644100	R 153.35	K 82529	
<b>KV 343</b>	F 16187		VKBA 3620	713644090	R 153.40		
<b>KB 344</b>	F 15174		VKBA 3614	713630780	R 140.01		
<b>KB 345</b>	F 15043		VKBA 3521	713667320	R 151.32		QWB 1069
<b>KF 346</b>	F 16131		VKBA 3538	713690750	R 158.44	K 80123	QWB 1102
<b>KA 347</b>	F 15164	F 15164	VKBA 918	713678290	R 152.32	K 81115	QWB 532
<b>KF 348</b>	F 16132		VKBA 3668	713649280			
<b>KA 349</b>	30206 F	30304 F	VKBA 708	713614010	R 178.00		QWB 493
<b>KB 350</b>	F 15175		VKBA 3639	713630950	R 155.77		QWB 1256
<b>KF 351</b>	F 16133		VKBA 3637	713630840	R 155.75		QWB 1254
<b>KF 352</b>	F 16134		VKBA 1346	713618370	R 169.14	K 83720	QWB 621
<b>KV 353</b>	F 16192		VKBA 3930	713618670	R 169.30		QWB 1291
<b>KF 354</b>	F 16135		VKBA 3657	713640310	R 166.03		QWB 455



Blank lined area for notes.



